

Quadro Divider

a product by **Cube Design**

Phone no: +45 86 98 74 11
Email: cube@cube-design.dk
Website: www.cube-design.dk/en
Version: 21-06-2024



Example for Quadro Divider

It is strongly recommended, to be a two-man job, when assembling the coffee station!

The list of components varies depending on the customer's order.

This example includes:

1. 3 x vertical frames
2. 2 x Quadro shelves
3. 1 x shelf with hanger bar
4. 1 x flower box
5. 4 x adjustable leveling feet
6. 1 x Quadro shelf
7. 1 x seat cushion
8. 1 x assembly tools
9. screws, bolts, washers, bushings, an assembly tool, and a hex key for assembling the divider.

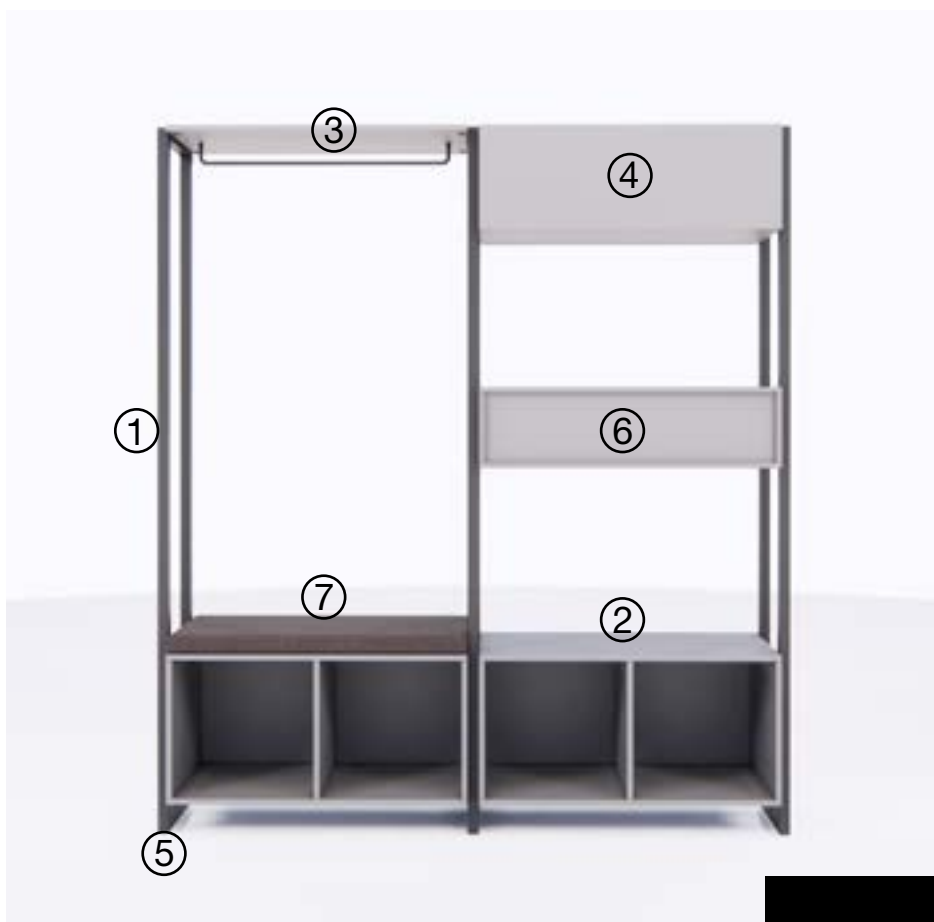

CUBE
DESIGN

Cube Design A/S

Vadstedvej 212 | DK-8450 Hammel | Phone no.: +45 86 98 74 11 | www.cube-design.dk/en | cube@cube-design.dk

Assembly principles for Quadro Divider

General assembly principles:

Note that the frames have different hole sizes (1)

The image illustrates the assembly principle where a bushing (2) is inserted into the frame (3)

After this, shelves, racks and other components can be secured with the provided bolts.

Shelves are secured with a countersunk hex screw (4), which is screwed into the bushing (2).

The special assembly tool (5) is used to hold the bushing, and the hex key (7) is used to tighten the hex screw while securing the shelf.

After this, the locking screw (6) can be screwed into the bushing.

Please note that in this case, the locking screw is not necessary, as the bushing is tightened against the frame.

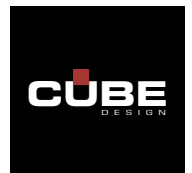
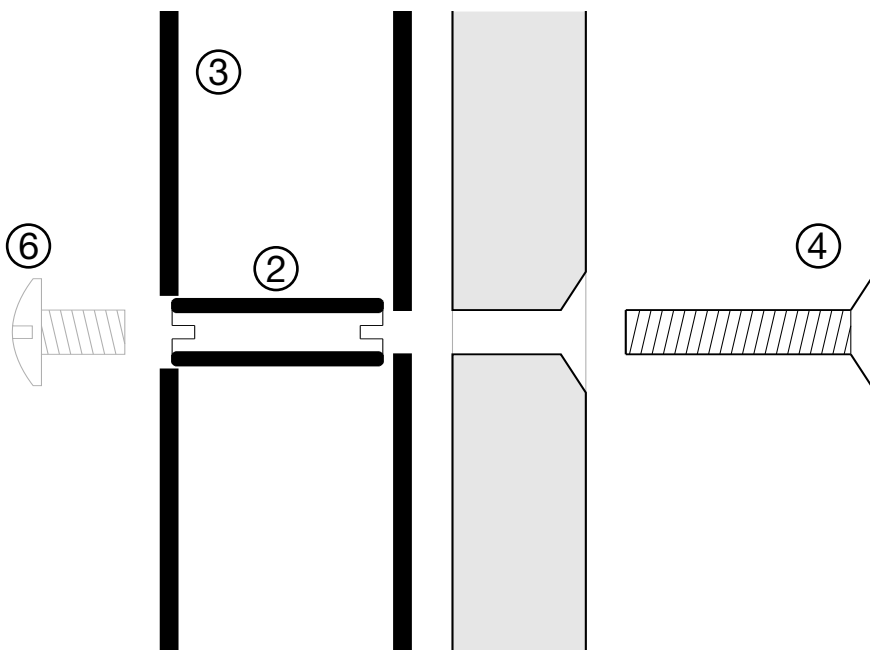

Assembly principles for Quadro Divider

General assembly principles:

Shelves are secured with a pan-head hex screw (1), which is screwed into the bushing (2) in the same manner as described above.

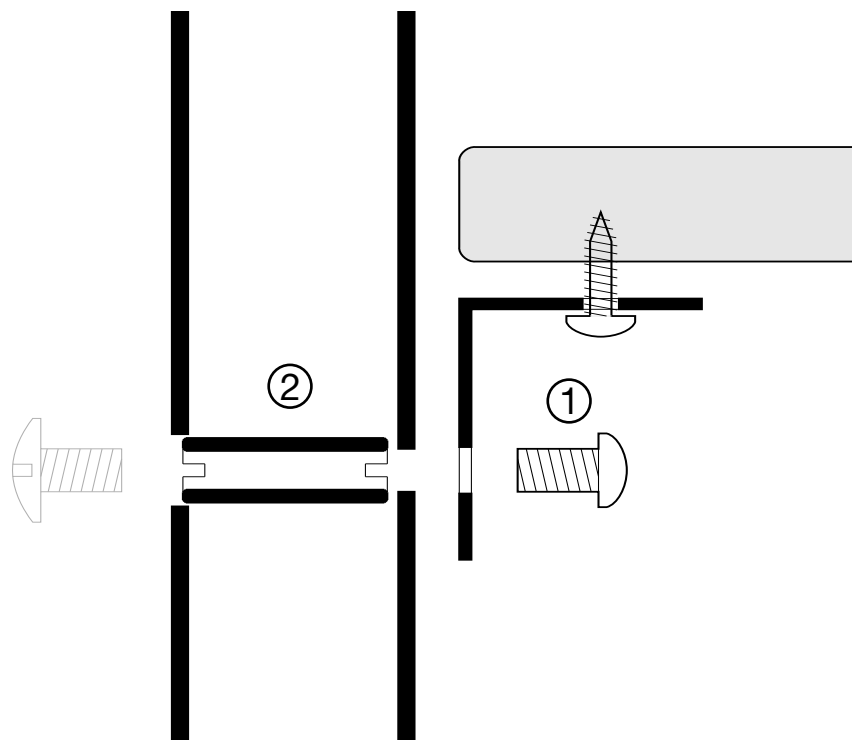

Assembly manual for Quadro Divider

Step 1: Assembly Quadro Divider on a soft but flat surface on the floor, such as a carpet.

Step 2: There are most modules in the marked section on the right. Therefore, assemble this section first.

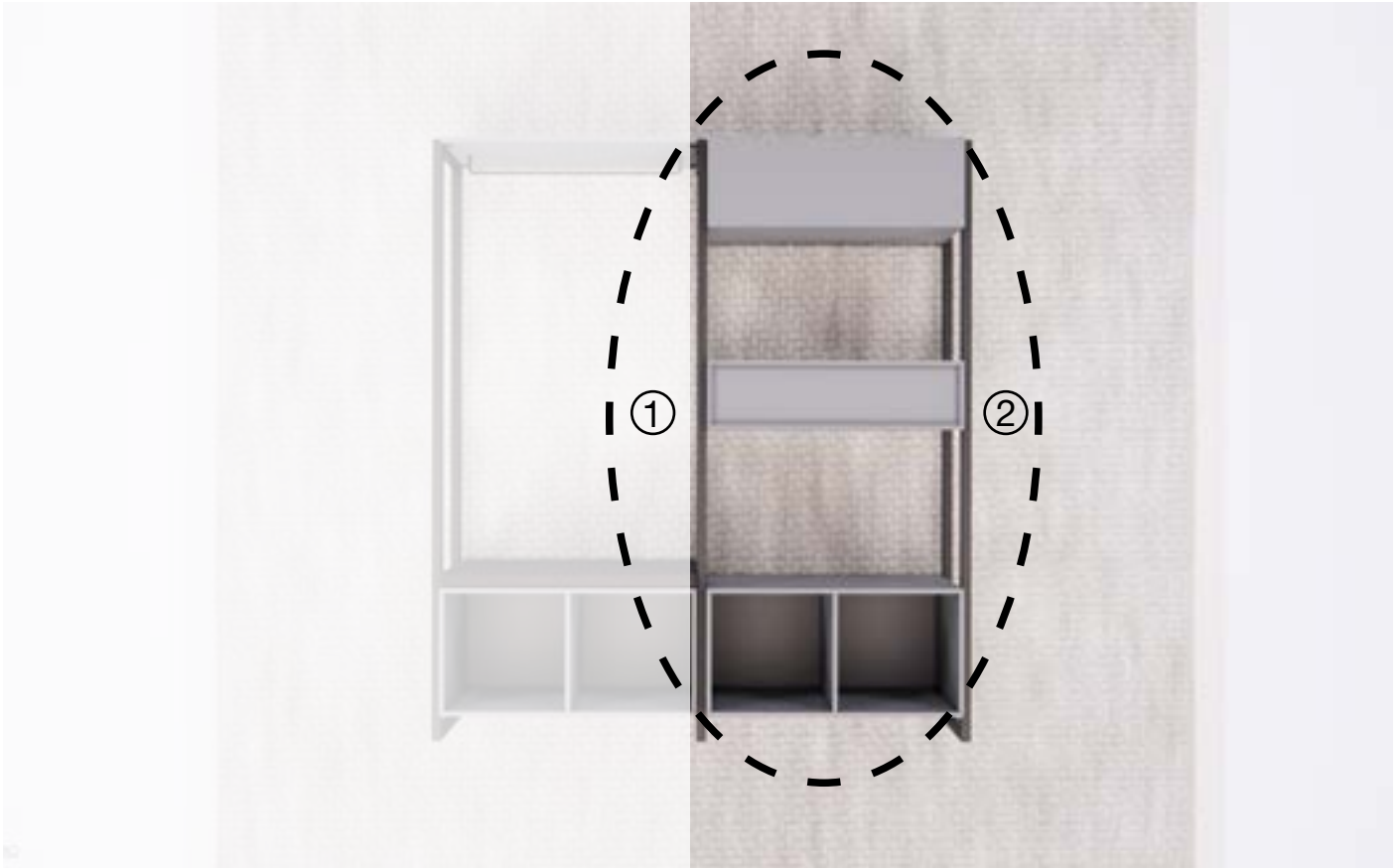

Step 3: Turn the frames so that the large holes are facing away from the shelves, and secure them as shown in the picture. Use the assembly tool (3) to hold the bushing in place. Tighten the screws just enough so they are snug but not overly tight. Fully tighten the shelf after the entire unit is assembled.

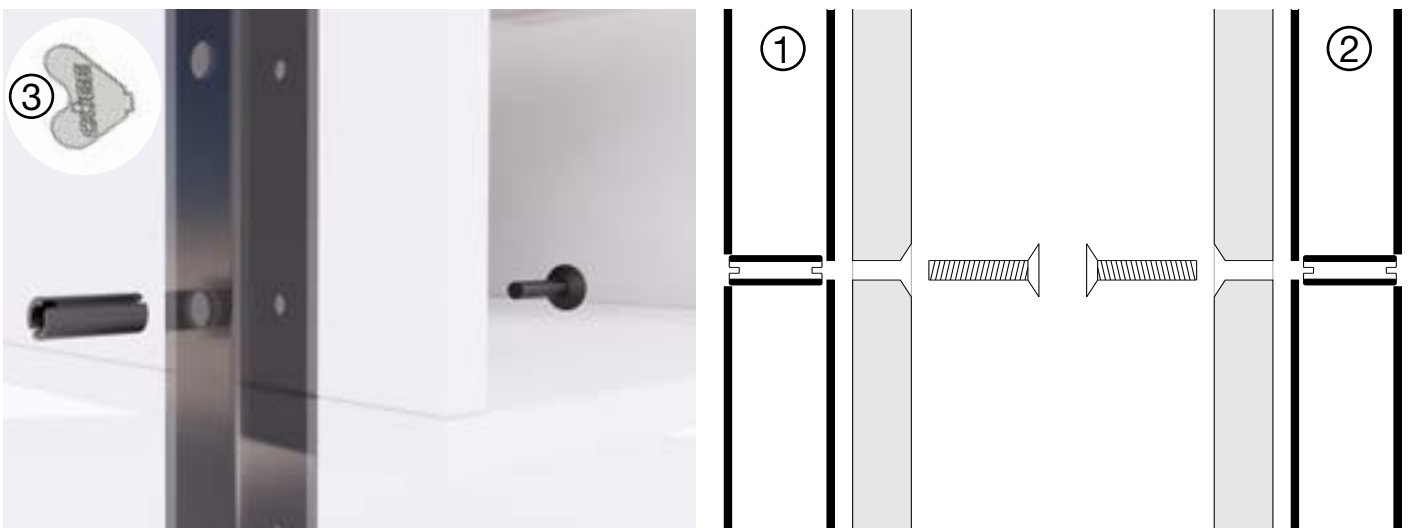

Assembly manual for Quadro Divider

Step 4: Assemble the shelf with the hanger bar using the provided wood screws and shelf brackets.



Step 5: Attach the hanger bar with a hex screw (1) and washer (2), as shown in the drawing.

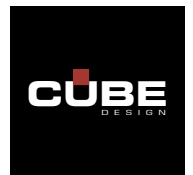
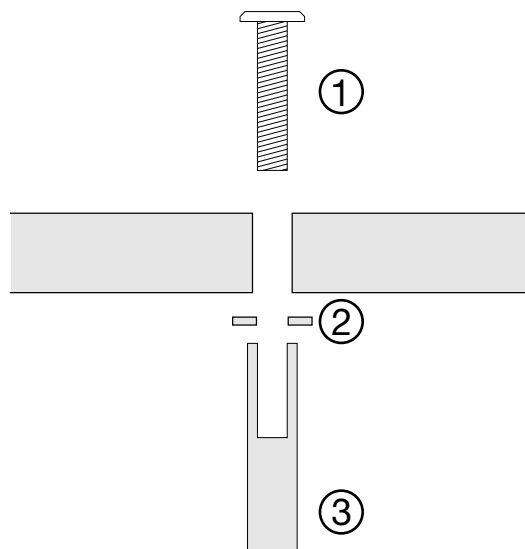
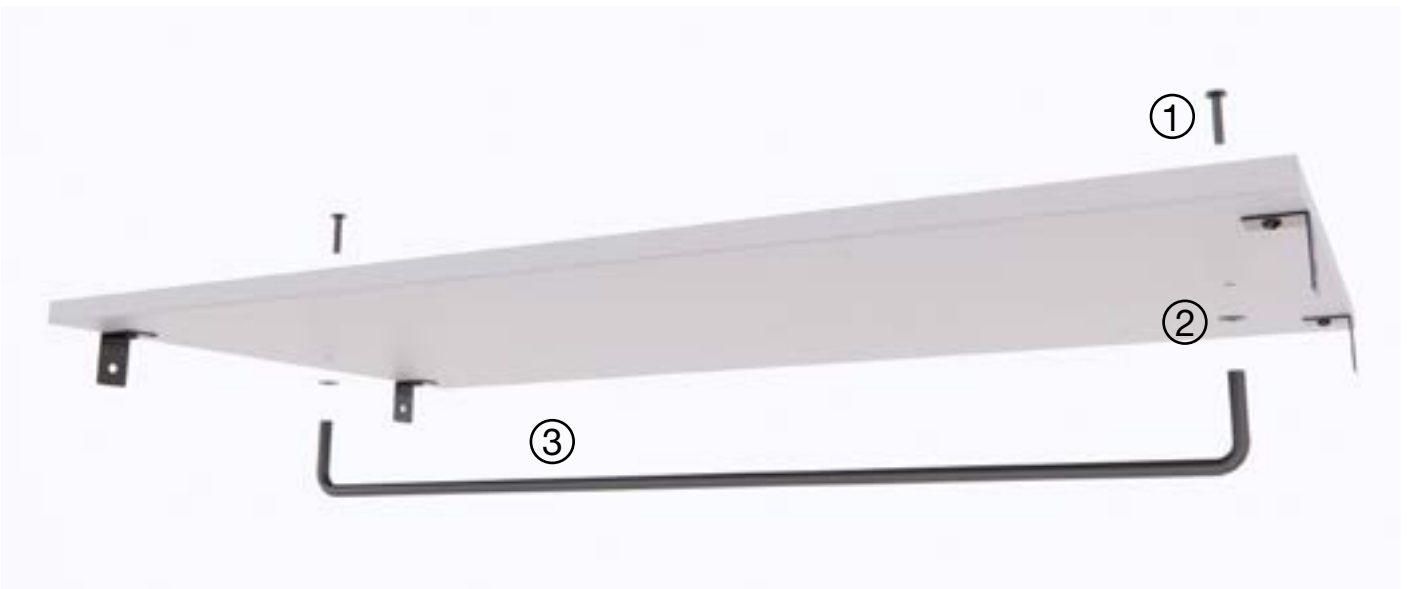

Cube Design A/S

Vadstedvej 212 | DK-8450 Hammel | Phone no.: +45 86 98 74 11 | www.cube-design.dk/en | cube@cube-design.dk

Assembly manual for Quadro Divider

Step 6: Now you can proceed to assemble the rest of the Quadro Divider.



Step 7: Turn the outer left vertical frame so that the large holes face outward, and assemble the shelf as shown in the diagrams. Tighten the screws just enough so they are snug but not overly tight. Fully tighten the shelf after the entire unit is assembled.

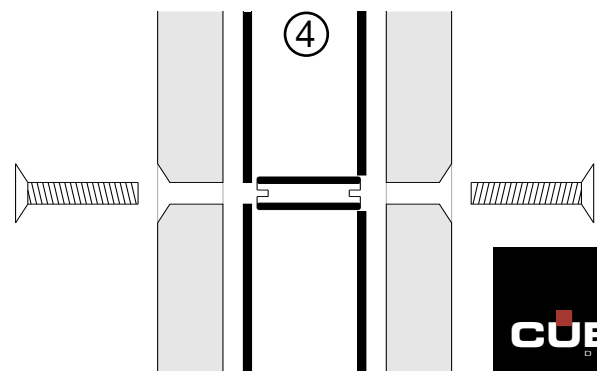
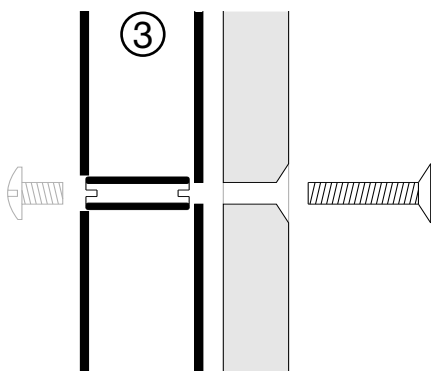
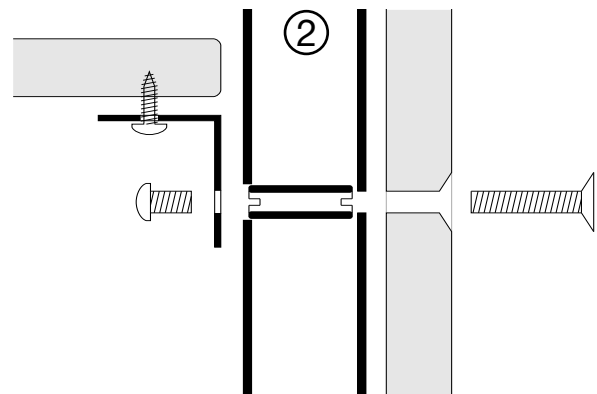
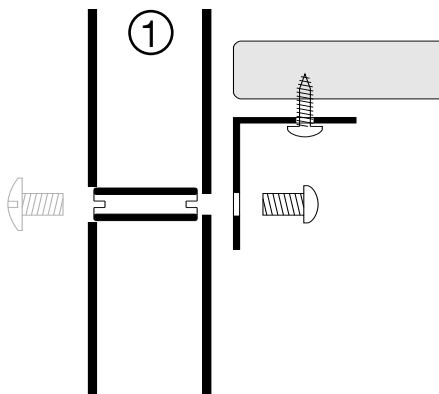

Assembly manual for Quadro Divider

Step 8: Position the Quadro Divider upright and place it in the desired location. Then adjust the leveling feet at the bottom of the frames to ensure the entire furniture piece is level and stable.

Step 9: Now tighten all screws in all bushings and brackets to ensure the Quadro Divider stands stable and secure.



Step 10: Finally, we strongly recommend securing the outer frames to the floor using a suitable screw. This is to prevent the furniture from tipping over. At the bottom of each frame, there is a hole (1) designed for this purpose - refer to the diagram.

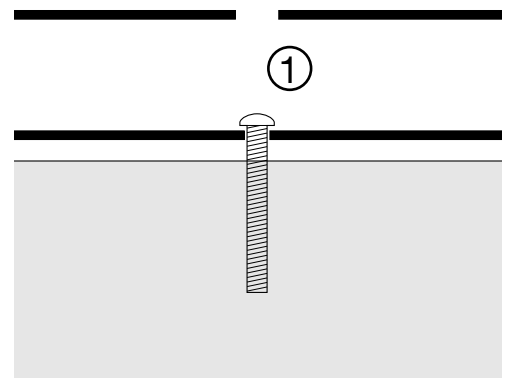

Enjoy your Quadro Divider!

