



# PRICE LIST

Valid from January 1st 2024

**CUBE**  
DESIGN

**Dear Reader**

Welcome to Cube Design's price list which is valid from January 1st 2024.

Cube Design is a Danish-owned furniture company based close to Hammel, Denmark. We place great emphasis on design, functionality and good quality in all products.

We have our own architects, who, together with our consultants, support and help with advice from start to finish. Our showroom in Svenstrup is always open for visits. Here you can see and test our products. Please contact Cube Design prior your visit in our showroom in Bredgade, Copenhagen (DK).

**Did you know :**

- The company was founded in 1980 by Aase & Curt Berggren and is still family run
- Our storage is delivered assembled. Only handles, legs and castors are to be mounted.
- Veneered plates are coated with 7 x UV lacquer and the edges are coated 3 x varnish. Lacquer comply with Danish and international requirements.
- All laminate table tops are made with high pressure laminate (HPL).
- 10 years warranty\* on all storage.
- 5 years warranty\* on everything else.

We hope that you find what is needed.

Please do not hesitate to contact us if you have any questions - we are here to help on email: [cube@cube-design.dk](mailto:cube@cube-design.dk) or phone no.: +45 86 98 74 11.

Remember, our architects are always available with advice, planning and decor!

Please enjoy!

**Cube Design is :**

FSC® certified\*\*  
(FSC C155594)



Environmental certified according  
to DS/EN ISO 14001:2015



EU Ecolabel certified  
(DK/049/022)



Member of Danish Furniture-  
makers' Quality Control



Member of  
pCon.planner

\* The warranty covers construction-, material- and production defects.

\*\* Request our FSC-certified products.



**Terms and conditions\* :****Terms of delivery**

Delivery at retailer store or warehouse. See current dealership.

Delivery at end-user or elsewhere by agreement only.

Duty and local duty fee are settled between the dealer and shipping agent.

Upon receipt the product must be controlled before signing the delivery note. A signed delivery note means that the product is intact and undamaged. Damage to goods must be noted on the freight bill and confirmed by the shipping agent.

**Returns**

Standard products can only be returned in original packaging and only by agreement. By returning we deduct 25%, however, 50% if repackaging is necessary.

Specially manufactured goods cannot be returned.

**Architectural assistance**

For architectural assistance and drawing by our in-house architects is a fee of EURO 95,- per started hour.

**Changes**

Cube reserves the right to change design (improvement) without notice.

Similarly, we reserve the right to change colors in the fabric, linoleum and laminate.

The, at any given time, valid pricelist\*\* is available on the website of Cube Design A/S :  
[www.cube-design.dk/en/downloads/pricelist/](http://www.cube-design.dk/en/downloads/pricelist/)

We reserve the right to correct misprints

We reserve the right to change prices due to exchange rate changes.

\* **Extract of Terms and conditions - see the full version in the back of the price list.**

\*\* **Price list Recommended retail prices excl. VAT. in Euro.**

# TABLE OF CONTENT

<b>EU ECOLABEL</b>	EU Ecolabel products.....	5
<b>STORAGE</b>	Qudaro recycling stations .....	7
	Qudaro storage and accessories .....	13
	Quadro sliding door cabinet and accessories.....	31
	Quadro pull-out cabinet and accessories .....	35
	Quadro drawer unit and accessories .....	39
	Qudaro lockers.....	43
	Wardrobe and coffee station .....	49
	Quadro Divider .....	53
	Quadro flower box.....	57
	V storage and accessories .....	61
	V pull-out cabinet and accessories .....	69
	Trolley, free standing screen, coat stand.....	73
<b>DESKS</b>	UP desks and accessories.....	75
	RAW desks and accessories.....	81
	Quadro desks and accessories.....	89
<b>CHAIRS</b>	S20 chairs.....	95
	S10 chairs.....	99
	Vesper chairs.....	103
<b>MEETING - / CONFERENCE / CANTEEN TABLES</b>	Verzo tables and accessories.....	105
	Verzo overview .....	110
	Spider tables and accessories .....	111
	Spider overview .....	116
	Quadro and Amigo tables and accessories .....	117
	Meeting and canteen tables.....	123
	Flap folding tables .....	127
	V folding tables.....	129
	Lite Cube gable tables .....	131
<b>INFORMATION DESK</b>	Modular information desk .....	134
	Quadro information desk.....	134
	Lite Cube information desk .....	135
<b>CONDITIONS</b>	Terms and conditions .....	136
<b>INDEX</b>	Index.....	138
<b>COLOR CHART</b>	Color chart.....	140

## EU ECOLABEL PRODUCTS



ECO Quadro storage:

Cabinet available in:

- **Laminate:** Opaque White, Montana Grey, Platinum Grey, Anthracite Grey, Slate Grey, Volcanic Black or Lindberg Oak.

Surface - fronts:

- Standard laminate
- Nordic Nature (HPL)\*
- Linoleum\*

Support:

- Plinth
- Plate plinth

EU ECO desks in general:

- Incl. cable tray
- 2x Ø60 cable grommets in black or white plastic
- Table top in 23 mm MDF
- Radius 20 on corners
- Soft start- / stop
- Low noise motor
- Piezo technology
- Rail free construction
- Lifts 80 kg per column
- CE marked

Frame and cable tray:

- White powder coat
- Black powder coat

2x Ø60 cable grommets:

- White plastic
- Black plastic

Edge:

- Rectangular ECO desks are delivered with bevelled edge or ABS edge
- ECO desks with stomach arch are delivered with bevelled edge

\* Note, with few exceptions

### EU Ecolabel in general:

- The range includes selected RAW desks and Quadro storage: bookcases, cabinets, lockers, pull-out cabinets and plinths\*
- All products that can be selected as EU Ecolabel are marked with "ECO" following the item number. Remember to state "ECO" after the item number if you order the product as EU Ecolabel
- It is not possible to change an EU Ecolabel product
- Find the color chart for EU Ecolabel products on page 6

### ECO Quadro storage in general:

- 2 mm impact-resistant ABS edge
- Choose between Quadro handle (white, black or mat chrome) or push bracket
- Cabinets/lockers available with Flexlock
- EN16121+EN16122 tested
- 10 years warranty

### ECO RAW desks in general:

- Rectangular or round columns with sit/stand function
- Height adjustment: 640-1280 mm
- Intuitive up/down adjustment
- EN527-1\_2 tested
- 5 years warranty

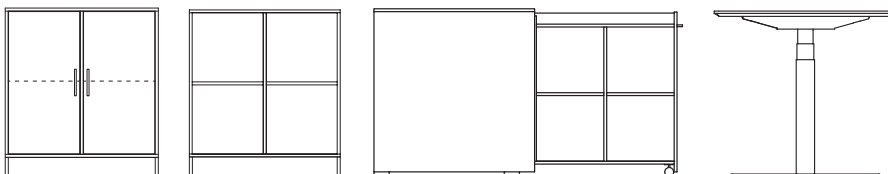



**Laminat**  
Cabinet ///////////////  
Fronts ///////////////  
**HPL**  
ECO table tops ////

Volcanic Black 12000 / 1015	Slate Grey 12231 / U164	Anthracite Grey 12290 / 1290	Platinum Grey 12115 / 1115	Montana Grey 12109 / 1109	Opaque White 10400 / 1040	Lindberg Oak 20021VV / 4223VV
--------------------------------	----------------------------	---------------------------------	-------------------------------	------------------------------	------------------------------	----------------------------------

**NORDIC NATURE**  
**HPL**  
ECO table tops ////  
Fronts ///////////////

Burgundy 17054	Bordeaux 17031	Powder 16037	Cashmere 12168	Congo 16002	Lava 12211	Bison 16013	Antelope 16012	Light Beige 16007
Dark Blue 18004	Water Blue 18002	Pastel Blue 18067	Lagoon 18505	Atlantic 18074	Skaggerak 18006	Zucchini 19504	Khaki 19512	Avocado 19503

**LINOLEUM**  
ECO table tops ////  
Fronts ///////////////

Nero 4023	Charcoal 4166	Iron 4178	Mauve 4172	Powder 4185	Conifer 4174	Olive 4184	Pistachio 4183	Spring Green 4182
Smokey Blue 4179	Pewter 4155	Ash 4132	Pebble 4175	Vapour 4177	Mushroom 4176	Pearl 4157	Burgundy 4154	Salsa 4164
Orange Blast 4186	Midnight Blue 4181	Aquavert 4180						

**Handles**  
Pull-out cabinet ////  
Cabinet //////////////

Quadro white	Quadro mat chrome	Quadro black
--------------	-------------------	--------------

**Frame/cable tray**  
RAW 3-stage //////////////

White powder coat	Black powder coat
-------------------	-------------------



# QUADRO RECYCLING STATION



Top available in:

- **Compact laminate with black core:** Opaque White, Platinum Grey, Volcanic Black or Neuro Portoro
- **Compact laminate with grey core:** Carrara Marble

Cabinet available in :

- **Laminate :** Opaque White, Montana Grey, Platinum Grey, Anthracite Grey, Slate Grey, Volcanic Black, Lindberg Oak or Congo.
- **Veneer :** ash, beech, maple, oak or walnut\*

The bookcases are delivered with laminate or veneer on back panel and can be used as dividers.

Surface - fronts :

- Standard laminate
- Nordic Nature (HPL)
- Veneer
- XP mat laminate\*
- Linoleum\*

Support :

- Plinth
- Plate plinth
- Leg plinth
- Wall bracket
- Castors
- Legs

\* Note surcharge see page 12.

## Recycling stations in general:

- Top in 12 mm compact laminate
- Cabinet and fronts made in 16 mm plates
- 7 cabinet colors in laminate
- 5 cabinet colors in veneer
- Back panel in 8 mm plates
- 2 mm impact-resistant ABS edge (laminate cabinet)
- 2 mm wooden edge (veneer cabinet)
- 33 colors in laminate - of which 20 are high pressure laminate
- Nordic Nature fronts in high pressure laminate
- Supplied as standard with milled handle Ø50/40 mm in stainless steel
- 10 years warranty
- Counterweight is recommended for 1 section stations with bag pullout\*
- Covers, castors, pictograms etc. can be found under accessories, page 12 (pictograms are installed by the customer)
- The recycling stations can be wall-mounted\*

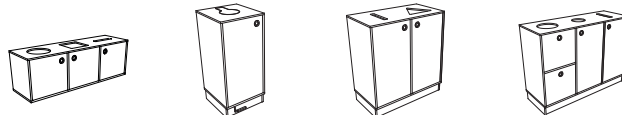

# QUADRO Recycling station, ready-made solutions

**Laminate**
**Veneer**

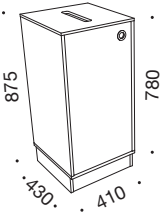
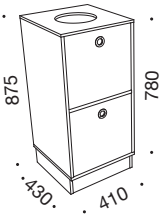
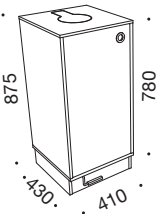
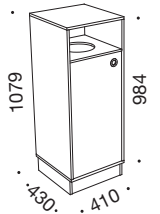
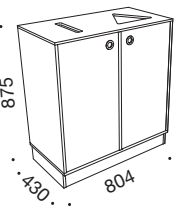
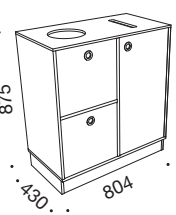
	<p><b>Recycling station, 1 section</b></p> <p>5380 1 section with Paper carving and room with bag pullout</p> <p>5402 Plinth (H 95 x W 406 x D 390 mm)</p> <p>Counterweight is recommended (note surcharge page 12).</p>	<p>520</p> <p>66</p>	<p>598</p> <p>79</p>
	<p><b>Recycling station, 1 section</b></p> <p>4101 1 section with Circle 210 carving and room with drawers incl. two plastic containers (20L) and a small plastic insert for batteries (1,3L)</p> <p>5402 Plinth (H 95 x W 406 x D 390 mm)</p>	<p>794</p> <p>66</p>	<p>879</p> <p>79</p>
	<p><b>Recycling station, 1 section</b></p> <p>4102 1 section with Cover Ø170 operated by a foot pedal and room with plastic container (48L)</p> <p>4104 1 section with Cover Ø230 operated by a foot pedal and room with bag pullout</p> <p>5402P Plinth for foot pedal (H 95 x W 406 x D 390 mm)</p> <p>Foot pedal in stainless steel.</p>	<p>679</p> <p>706</p> <p>66</p>	<p>757</p> <p>783</p> <p>79</p>
	<p><b>Recycling station, 1 section with throw in</b></p> <p>4103 1 section with throw in, Circle 210 carving and room with bag pullout</p> <p>5402 Plinth (H 95 x W 406 x D 390 mm)</p> <p>Counterweight is recommended (note surcharge page 12).</p>	<p>578</p> <p>66</p>	<p>666</p> <p>79</p>
	<p><b>Recycling station, 2 sections</b></p> <p>5381 2 sections with A: Paper carving and room with bag pullout B: Triangle carving and room with bag pullout</p> <p>5412 Plinth (H 95 x W 800 x D 390 mm)</p>	<p>895</p> <p>76</p>	<p>1.036</p> <p>90</p>
	<p><b>Recycling station, 2 sections</b></p> <p>4115 2 sections with A: Circle 210 carving and room with drawers incl. two plastic containers (20L) and a plastic insert for batteries (1,3L) B: Paper carving and room with bag pullout</p> <p>5412 Plinth (H 95 x W 800 x D 390 mm)</p>	<p>1.141</p> <p>76</p>	<p>1.317</p> <p>90</p>

Prices in EURO

 Laminate : Opaque White, Montana Grey, Platinum Grey, Anthracite Grey, Slate Grey, Volcanic Black or Lindberg Oak.  
 Veneer : ash, beech, maple or oak + 25% surcharge for walnut



# QUADRO Recycling station, ready-made solutions

**Laminate**
**Veneer**

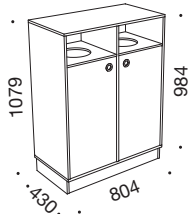
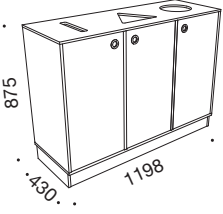
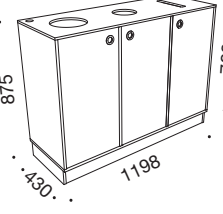
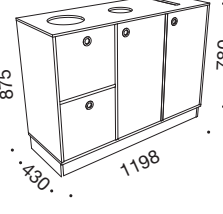
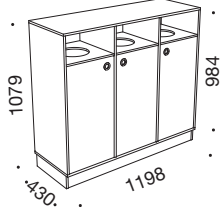
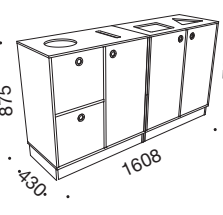
	<p><b>Recycling station, 2 sections with throw in</b></p> <p>4116 2 sections with A/B: throw in, Circle 210 carving and room with bag pullout</p> <p>5412 Plinth (H 95 x W 800 x D 390 mm)</p>	<p>1.019</p> <p>76</p>	<p>1.170</p> <p>90</p>
	<p><b>Recycling station, 3 sections</b></p> <p>5382 3 sections with A: Paper carving and room with bag pullout B: Triangle carving and room with bag pullout C: Circle 210 carving and room with bag pullout</p> <p>5435 Plinth (H 95 x W 1194 x D 390 mm)</p>	<p>1.306</p> <p>93</p>	<p>1.508</p> <p>113</p>
	<p><b>Recycling station, 3 sections</b></p> <p>4125 3 sections with A: Batterie throw-in/circle 210 mm carving and room with plastic container connected to a batterie throw-in and a plastic container (48L) B: Circle 150 and room with bag pullout C: Paper carving and room with bag pullout</p> <p>5435 Plinth (H 95 x W 1194 x D 390 mm)</p>	<p>1.397</p> <p>93</p>	<p>1.599</p> <p>113</p>
	<p><b>Recycling station, 3 sections</b></p> <p>4126 3 sections with A: Circle 210 carving and room with drawers incl. two plastic containers (20L) and a plastic insert for batteries (1,3L) B: Circle 150 and room with bag pullout C: Paper carving and room with bag pullout</p> <p>5435 Plinth (H 95 x W 1194 x D 390 mm)</p>	<p>1.551</p> <p>93</p>	<p>1.788</p> <p>113</p>
	<p><b>Recycling station, 3 sections with throw in</b></p> <p>4127 3 sections with A/B/C: throw in, Circle 210 carving and room with bag pullout</p> <p>5435 Plinth (H 95 x W 1194 x D 390 mm)</p>	<p>1.653</p> <p>93</p>	<p>1.908</p> <p>113</p>
	<p><b>Recycling station, 2x2 sections</b></p> <p>Total Price</p> <p>5381 A: Circle 210 carving and room with drawers incl. two plastic containers (20L) and a plastic insert for batteries (1,3L) B: Paper carving and room with bag pullout</p> <p>4115 A: Square carving and room with bag pullout B: Triangle carving and room with bag pullout</p> <p>5412 2 x plinth (H 95 x B 800 x D 390 mm)</p>	<p>2.188</p>	<p>2.533</p>

Prices in EURO

# QUADRO Recycling stations, individual solutions

**Laminate**
**Veneer**

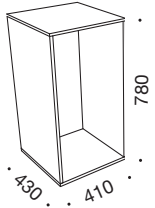
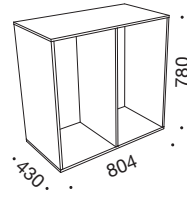
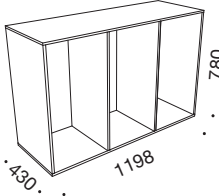
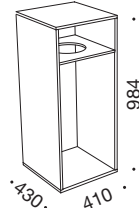
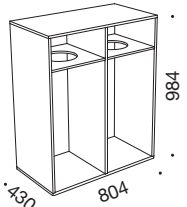
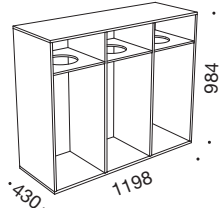

	<p><b>Recycling station, 1 section cabinet</b></p> <table border="0"> <tr> <td>5081</td> <td>1 section, empty cabinet</td> <td>246</td> <td>291</td> </tr> <tr> <td>5402</td> <td>Plinth (H 95 x W 406 x D 390 mm)</td> <td>66</td> <td>79</td> </tr> <tr> <td>5402P</td> <td>Plinth for foot pedal (H 95 x W 406 x D 390 mm)</td> <td>66</td> <td>79</td> </tr> </table> <p>Please inform which kind of carving and room you want.</p>	5081	1 section, empty cabinet	246	291	5402	Plinth (H 95 x W 406 x D 390 mm)	66	79	5402P	Plinth for foot pedal (H 95 x W 406 x D 390 mm)	66	79
5081	1 section, empty cabinet	246	291										
5402	Plinth (H 95 x W 406 x D 390 mm)	66	79										
5402P	Plinth for foot pedal (H 95 x W 406 x D 390 mm)	66	79										
	<p><b>Recycling station, 2 section cabinet</b></p> <table border="0"> <tr> <td>5082</td> <td>2 sections, empty cabinet</td> <td>348</td> <td>424</td> </tr> <tr> <td>5412</td> <td>Plinth (H 95 x W 800 x D 390 mm)</td> <td>76</td> <td>90</td> </tr> <tr> <td>5412P</td> <td>Plinth for foot pedal (H 95 x W 800 x D 390 mm)</td> <td>78</td> <td>92</td> </tr> </table> <p>Please inform which kind of carving and room you want in section A and B.</p>	5082	2 sections, empty cabinet	348	424	5412	Plinth (H 95 x W 800 x D 390 mm)	76	90	5412P	Plinth for foot pedal (H 95 x W 800 x D 390 mm)	78	92
5082	2 sections, empty cabinet	348	424										
5412	Plinth (H 95 x W 800 x D 390 mm)	76	90										
5412P	Plinth for foot pedal (H 95 x W 800 x D 390 mm)	78	92										
	<p><b>Recycling station, 3 section cabinet</b></p> <table border="0"> <tr> <td>5083</td> <td>3 sections, empty cabinet</td> <td>484</td> <td>588</td> </tr> <tr> <td>5435</td> <td>Plinth (H 95 x W 1194 x D 390 mm)</td> <td>93</td> <td>113</td> </tr> <tr> <td>5435P</td> <td>Plinth for foot pedal (H 95 x W 1194 x D 390 mm)</td> <td>95</td> <td>116</td> </tr> </table> <p>Please inform which kind of carving and room you want in section A, B and C.</p>	5083	3 sections, empty cabinet	484	588	5435	Plinth (H 95 x W 1194 x D 390 mm)	93	113	5435P	Plinth for foot pedal (H 95 x W 1194 x D 390 mm)	95	116
5083	3 sections, empty cabinet	484	588										
5435	Plinth (H 95 x W 1194 x D 390 mm)	93	113										
5435P	Plinth for foot pedal (H 95 x W 1194 x D 390 mm)	95	116										
	<p><b>Recycling station, 1 section with throw in, cabinet</b></p> <table border="0"> <tr> <td>5086</td> <td>1 section with throw in, empty cabinet</td> <td>303</td> <td>360</td> </tr> <tr> <td>5402</td> <td>Plinth (H 95 x W 406 x D 390 mm)</td> <td>66</td> <td>79</td> </tr> </table> <p>Please inform which kind of carving and room you want. Note that you only can choose between 5093, 5091 and 5090 for this type of cabinet.</p>	5086	1 section with throw in, empty cabinet	303	360	5402	Plinth (H 95 x W 406 x D 390 mm)	66	79				
5086	1 section with throw in, empty cabinet	303	360										
5402	Plinth (H 95 x W 406 x D 390 mm)	66	79										
	<p><b>Recycling station, 2 sections with throw in, cabinet</b></p> <table border="0"> <tr> <td>5087</td> <td>2 sections with throw in, empty cabinet</td> <td>471</td> <td>557</td> </tr> <tr> <td>5412</td> <td>Plinth (H 95 x W 800 x D 390 mm)</td> <td>76</td> <td>90</td> </tr> </table> <p>Please inform which kind of carving and room you want. Note that you only can choose between 5093, 5091 and 5090 for this type of cabinet.</p>	5087	2 sections with throw in, empty cabinet	471	557	5412	Plinth (H 95 x W 800 x D 390 mm)	76	90				
5087	2 sections with throw in, empty cabinet	471	557										
5412	Plinth (H 95 x W 800 x D 390 mm)	76	90										
	<p><b>Recycling station, 3 sections with throw in, cabinet</b></p> <table border="0"> <tr> <td>5088</td> <td>3 sections with throw in, empty cabinet</td> <td>830</td> <td>989</td> </tr> <tr> <td>5435</td> <td>Plinth (H 95 x W 1194 x D 390 mm)</td> <td>93</td> <td>113</td> </tr> </table> <p>Please inform which kind of carving and room you want. Note that you only can choose between 5093, 5091 and 5090 for this type of cabinet.</p>	5088	3 sections with throw in, empty cabinet	830	989	5435	Plinth (H 95 x W 1194 x D 390 mm)	93	113				
5088	3 sections with throw in, empty cabinet	830	989										
5435	Plinth (H 95 x W 1194 x D 390 mm)	93	113										

Prices in EURO

**QUADRO** Recycling stations, individual solutions

Laminate

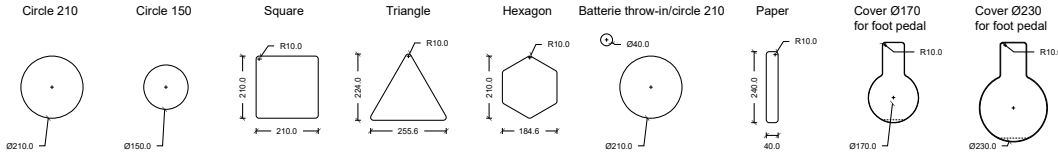
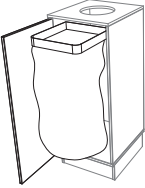
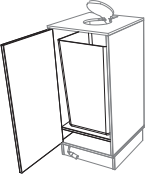
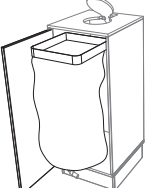
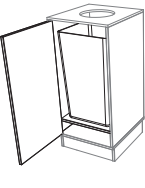
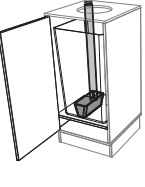
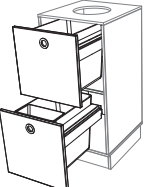
Veneer

	<p><b>Carvings</b></p> <p>We offer nine different carvings in the top:</p> <p>Circle 210    Circle 150    Square    Triangle    Hexagon    Batterie throw-in/circle 210    Paper    Cover Ø170 for foot pedal    Cover Ø230 for foot pedal</p> 
	<p><b>Room with bag pullout, incl. door</b></p> <p>5093    Room with bag pullout, incl. door    274    307</p> <p>Note that trash bags can be purchased separately (page 12).</p>
	<p><b>Room for a cover Ø170 mm operated by foot pedal, incl. door</b></p> <p>5095    Room with plastic container (48L) and a shelf, incl. door    433    466</p> <p>Note that you only can choose the carving with cover Ø170 mm to foot pedal for this room.</p> <p>Can only be delivered with a plinth.</p>
	<p><b>Room for a cover Ø230 mm operated by foot pedal, incl. door</b></p> <p>5096    Room with bag pullout, incl. door    459    491</p> <p>Note that you only can choose the carving with cover Ø230 mm to foot pedal for this room.</p> <p>Can only be delivered with a plinth.</p>
	<p><b>Room with plastic container and shelf, incl. door</b></p> <p>5091    Room with plastic container (48L) and a shelf, incl. door    274    307</p>
	<p><b>Room for batterie throw-in/circle 210, incl. door</b></p> <p>5094    Room with a small plastic container connected to a batterie throw-in, a plastic container (48L) and a shelf, incl. door    365    398</p> <p>Note that you only can choose the batterie throw-in/circle 210 carving for this room.</p>
	<p><b>Room with drawer and plastic containers</b></p> <p>5090    Room with drawers incl. two plastic containers (20L) and a small plastic insert for batteries (1,3L)    519    587</p> 



Prices in EURO



# QUADRO Wall-mounted recycling station

Laminate

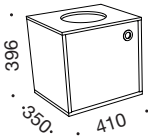
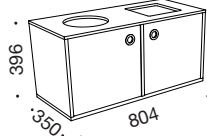
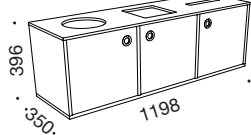
Veneer

	<p><b>Wall-mounted recycling station, 1 section</b></p> <p>4130 1 section with Circle 210 carving and room with plastic container (20L)</p> <p>Incl. double wall bracket. Note, is delivered with six different carvings: Circle Ø210, circle Ø150, square, triangle, hexagon and paper.</p>	<p>379</p>	<p>413</p>
	<p><b>Wall-mounted recycling station, 2 sections</b></p> <p>4131 2 sections with</p> <p>A: Circle 210 carving and room with plastic container (20L)</p> <p>B: Square and room with plastic container (20L)</p> <p>Incl. double wall bracket. Note, is delivered with six different carvings: Circle Ø210, circle Ø150, square, triangle, hexagon and paper.</p>	<p>639</p>	<p>706</p>
	<p><b>Wall-mounted recycling station, 3 sections</b></p> <p>4132 3 sections with</p> <p>A: Circle 210 carving and room with plastic container (20L)</p> <p>B: Square and room with plastic container (20L)</p> <p>C: Paper and room with plastic container (20L)</p> <p>Incl. double wall bracket. Note, is delivered with six different carvings: Circle Ø210, circle Ø150, square, triangle, hexagon and paper.</p>	<p>887</p>	<p>940</p>
 <p>7 slats</p>	<p><b>Surcharge</b></p> <p>7952 Door with 7 slats, per 1 room high door</p> <p>7953 Door with 7 slats, per 2 room high door</p>	<p><b>Laminate/Veneer</b></p>	<p>58</p> <p>69</p>
 <p><b>7960</b></p>	<p><b>Surcharge/accessories</b></p> <p>5553 Fronts with linoleum or XP laminate, per door/drawer 34</p> <p>7960 Pictograms, 1 sheet with 11 different pictograms, per sheet 36</p> <p>Please inform which language: Danish, Norwegian or English</p> <p>5529 Counterweight 81</p> <p>5078 Hidden castors for a plinth, set of 4 castors 38</p> <p>(recommended for 1 and 2 sections stations)</p> <p>5079 Hidden castors for a plinth, set of 6 castors 57</p> <p>(recommended for 3 sections stations)</p> <p>5527 Standard castor (grey), 1 pcs. 19</p> <p>5099 Cover with knob handle for a recycling station with Circle 210 carving 143</p> <p>5098 Cover with knob handle for a recycling station with Square carving 143</p> <p>7976 Trash bags (55L, 600 x 900 mm), 100 pcs. 151</p> <p>7974 Trash bags for 20L plastic container, 100 pcs. 69</p> <p>5525 Wall bracket 57</p>	<p><b>Price</b></p>	

Prices in EURO

Laminate : Opaque White, Montana Grey, Platinum Grey, Anthracite Grey, Slate Grey, Volcanic Black or Lindberg Oak.  
Veneer : ash, beech, maple or oak + 25% surcharge for walnut

# QUADRO STORAGE



Cabinet available in :

- **Laminate** : Opaque White, Montana Grey, Platinum Grey, Anthracite Grey, Slate Grey, Volcanic Black, Lindberg Oak or Congo
- **Veneer** : ash, beech, maple, oak or walnut

The bookcases are delivered with laminate or veneer on back panel and can be used as dividers.

Fronts :

- Door
- Glass door
- Roll front door
- Drawer
- Letter trays
- Filing cabinet

Surface - fronts :

- Standard laminate
- Nordic Nature (HPL)
- Veneer
- XP mat laminate
- Linoleum

Support :

- Plinth
- Plate plinth
- Leg plinth
- Wall bracket
- Castors
- Legs
- Corner feet

\* We recommend that storage over 3 rooms high are fixed to the wall or floor.

## Quadro storage in general :





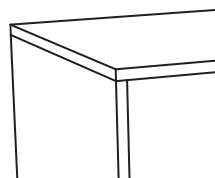





- Bookcases in 16 mm plates
- 7 cabinet colors in laminate
- 5 cabinet colors in veneer
- 7 supports
- 3 widths on bookcases and cabinets
- 7 heights\*
- 2 depths: D 350 and D 430 mm
- Back panel in 8 mm plates
- Can be used as dividers
- 2 mm impact-resistant ABS edge (laminate cabinet)
- 2 mm wooden edge (veneer cabinet)
- 33 colors in laminate - of which 20 are high pressure laminate
- Nordic Nature fronts in high pressure laminate
- 9 different handles
- Delivered assembled - only handles, legs and castors are to be mounted
- EN16121+EN16122 tested
- 10 years warranty

A5	B5	C5
A4	B4	C4
A3	B3	C3
A2	B2	C2
A1	B1	C1



# QUADRO Storage

**EU Ecolabel  
product in  
laminate**
**Laminate**
**Veneer**

 216 · 410 ·	<b>Bookcase</b> 5421 Bookcase, D 350 mm 5424 Bookcase, D 430 mm	-	104	123
		-	122	146
 · 400 · · 410 ·	<b>Bookcase</b> 5304 <b>ECO</b> Bookcase, D 350 mm 5324 <b>ECO</b> Bookcase, D 430 mm	104	104	123
		122	122	146
 · 400 · · 410 ·	<b>Cabinet</b> 5305 <b>ECO</b> Cabinet, D 350 mm 5322 <b>ECO</b> Cabinet, D 430 mm The door is by default left hinged.	184	184	217
		202	202	240
 600 · 410 ·	<b>Bookcase</b> 5328 <b>ECO</b> Bookcase, D 350 mm 5329 <b>ECO</b> Bookcase, D 430 mm	189	189	228
		221	221	265
 784 · 410 ·	<b>Bookcase</b> 5302 <b>ECO</b> Bookcase, D 350 mm 5342 <b>ECO</b> Bookcase, D 430 mm	189	189	228
		221	221	265
 784 · 410 ·	<b>Cabinet</b> 5303 <b>ECO</b> Cabinet, D 350 mm 5343 <b>ECO</b> Cabinet, D 430 mm Note, 1 shelf behind door. The door is by default left hinged.	301	301	373
		333	333	410
 784 · 410 ·	<b>Cabinet with suspension file drawers, D 430 mm</b> 5344 Filing cabinet with 2 suspension file drawers and pull out barrier	-	587	631
 984 · 410 ·	<b>Bookcase</b> 5301 <b>ECO</b> Bookcase, D 350 mm 5345 <b>ECO</b> Bookcase, D 430 mm	260	260	313
		281	281	337
 1168 · 410 ·	<b>Bookcase</b> 5306 <b>ECO</b> Bookcase, D 350 mm 5346 <b>ECO</b> Bookcase, D 430 mm	260	260	313
		281	281	337
 1168 · 410 ·	<b>Cabinet</b> 5307 <b>ECO</b> Cabinet, D 350 mm 5347 <b>ECO</b> Cabinet, D 430 mm Note, 2 shelves behind door. The door is by default left hinged.	427	427	513
		448	448	537



Prices in EURO

 Laminate : Opaque White, Montana Grey, Platinum Grey, Anthracite Grey, Slate Grey, Volcanic Black or Lindberg Oak.  
 Veneer : ash, beech, maple or oak + 25% surcharge for walnut

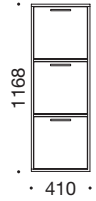
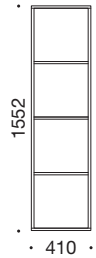
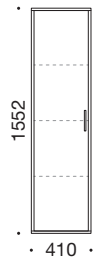
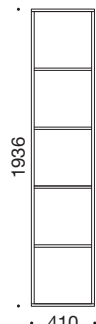
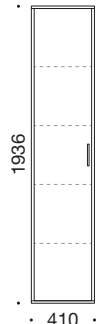

# QUADRO Storage

**EU Ecolabel  
product in  
laminate**
**Laminate**
**Veneer**

	<p><b>Cabinet with suspension file drawers, D 430 mm</b></p> <p>5348 Filing cabinet with 3 suspension file drawers and pull out barrier</p>	-	830	886
	<p><b>Bookcase</b></p> <p>5308ECO Bookcase, D 350 mm</p> <p>5364ECO Bookcase, D 430 mm</p>	325	325	391
	<p><b>Cabinet</b></p> <p>5299ECO Cabinet, D 350 mm</p> <p>5298ECO Cabinet, D 430 mm</p> <p>Note, 3 shelves behind the door. The door is by default left hinged.</p>	511	511	616
	<p><b>Bookcase</b></p> <p>5309ECO Bookcase, D 350 mm</p> <p>5366ECO Bookcase, D 430 mm</p>	367	367	439
	<p><b>Cabinet</b></p> <p>5297ECO Cabinet, D 350 mm</p> <p>5378ECO Cabinet, D 430 mm</p> <p>Note, 4 shelves behind door. The door is by default left hinged.</p>	578	578	694
	<p><b>Plinths (1-room wide)</b></p> <p>5401ECO Low plinth for D 350 (H95xW406xD310mm)</p> <p>5402ECO Low plinth for D 430 (H95xW406xD390mm)</p> <p>5404ECO High plinth for D 350 (H216xW406xD310mm)</p> <p>5403ECO High plinth for D 430 (H216xW406xD390mm)</p>	66	66	79
		66	66	79
		111	111	133
		111	111	133

Prices in EURO

 Laminate : Opaque White, Montana Grey, Platinum Grey, Anthracite Grey, Slate Grey, Volcanic Black or Lindberg Oak.  
 Veneer : ash, beech, maple or oak + 25% surcharge for walnut

# QUADRO Storage

EU Ecolabel  
product in  
laminate

Laminate

Veneer

	<p><b>Bookcase</b> (Divider can be removed - see surcharge page 20)</p> <p>5422 Bookcase, D 350 mm - 189 227</p> <p>5427 Bookcase, D 430 mm - 221 265</p>
	<p><b>Bookcase</b> (Divider can be removed - see surcharge page 20)</p> <p>5313<sup>ECO</sup> Bookcase, D 350 mm 189 189 227</p> <p>5332<sup>ECO</sup> Bookcase, D 430 mm 221 221 265</p>
	<p><b>Open bookcase, no backing</b></p> <p>5264 Open bookcase, D 350 mm - 189 227</p> <p>5265 Open bookcase, D 430 mm - 221 265</p>
	<p><b>Cabinet</b> (Divider can be removed - see surcharge page 20)</p> <p>5314<sup>ECO</sup> Cabinet, D 350 mm 349 349 415</p> <p>5333<sup>ECO</sup> Cabinet, D 430 mm 381 381 453</p>
	<p><b>Bookcase</b> (Divider can be removed - see surcharge page 20)</p> <p>5316<sup>ECO</sup> Bookcase, D 350 mm 308 308 372</p> <p>5354<sup>ECO</sup> Bookcase, D 430 mm 340 340 415</p>
	<p><b>Bookcase</b> (Divider can be removed - see surcharge page 20)</p> <p>5310<sup>ECO</sup> Bookcase, D 350 mm 308 308 372</p> <p>5320<sup>ECO</sup> Bookcase, D 430 mm 340 340 415</p> <p>Only 1-room high doors for this model.</p>
	<p><b>Bookcase</b> (Divider can be removed - see surcharge page 20)</p> <p>5311<sup>ECO</sup> Bookcase, D 350 mm 308 308 372</p> <p>5351<sup>ECO</sup> Bookcase, D 430 mm 340 340 415</p>
	<p><b>Cabinet</b> (Divider can be removed - see surcharge page 20)</p> <p>5312<sup>ECO</sup> Cabinet, D 350 mm 532 532 662</p> <p>5352<sup>ECO</sup> Cabinet, D 430 mm 564 564 705</p> <p>Note, 1 shelf behind each door.</p>
	<p><b>Cabinet with suspension file drawers, D 430 mm</b></p> <p>5353 Filing cabinet with 4 suspension file drawers and pull out barrier. - 1.072 1.147</p>
	<p><b>Cabinet with maxi suspension file drawers, D 430 mm</b></p> <p>5360 Filing cabinet with 2 maxi suspension file drawers - 1.282 1.357</p> <p>Pull out barrier and synchronization is standard.</p>
	<p><b>Roll front cabinet, D 430 mm</b></p> <p>5356 Roll front cabinet (Inside view : see model 5320) - 712 853</p> <p>It is possible to install up to 2 pcs. suspension file frame (5519).</p> <p>Note, not available with wall bracket. Fronts not available in Lindberg Oak.</p>

Prices in EURO

Laminate : Opaque White, Montana Grey, Platinum Grey, Anthracite Grey, Slate Grey, Volcanic Black or Lindberg Oak.  
Veneer : ash, beech, maple or oak + 25% surcharge for walnut

# QUADRO Storage

**EU Ecolabel  
product in  
laminate**
**Laminate**
**Veneer**

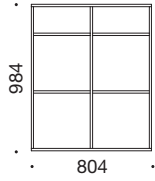
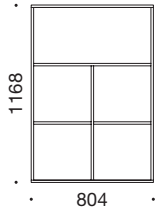
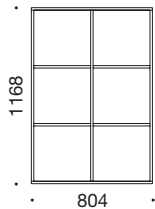
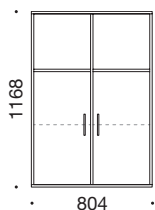
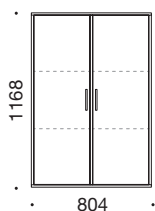
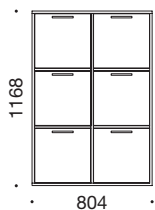
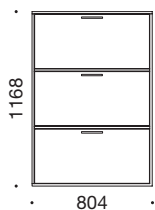
	<p><b>Bookcase</b> (Divider can be removed - see surcharge page 20)</p> <p>5315<b>ECO</b> Bookcase, D 350 mm 421 421 505</p> <p>5355<b>ECO</b> Bookcase, D 430 mm 438 438 524</p>
	<p><b>Bookcase</b> (Divider can be removed - see surcharge page 20)</p> <p>5327<b>ECO</b> Bookcase, D 350 mm 421 421 505</p> <p>5321<b>ECO</b> Bookcase, D 430 mm 438 438 524</p> <p>Only 1- and 2-room high doors for this model. Note, not supplied with wall mount.</p>
	<p><b>Bookcase</b> (Divider can be removed - see surcharge page 20)</p> <p>5317<b>ECO</b> Bookcase, D 350 mm 421 421 505</p> <p>5357<b>ECO</b> Bookcase, D 430 mm 438 438 524</p>
	<p><b>Cabinet</b> (Divider can be removed - see surcharge page 20)</p> <p>5319<b>ECO</b> Cabinet, D 350 mm 645 645 795</p> <p>5326<b>ECO</b> Cabinet, D 430 mm 662 662 814</p> <p>Note, 1 shelf behind each door.</p>
	<p><b>Cabinet</b> (Divider can be removed - see surcharge page 20)</p> <p>5318<b>ECO</b> Cabinet, D 350 mm 755 755 905</p> <p>5358<b>ECO</b> Cabinet, D 430 mm 772 772 924</p> <p>Note, 2 shelves behind each door.</p>
	<p><b>Cabinet with suspension file drawers, D 430 mm</b></p> <p>5359 Filing cabinet with 6 suspension file drawers and pull out barrier - 1.536 1.622</p>
	<p><b>Cabinet with maxi suspension file drawers, D 430 mm</b></p> <p>5361 Filing cabinet with 3 maxi suspension file drawers and pull out barrier - 1.851 1.937</p> <p>Pull out barrier and synchronization is standard.</p>

Prices in EURO

# QUADRO Storage

EU Ecolabel  
product in  
laminate

Laminate

Veneer

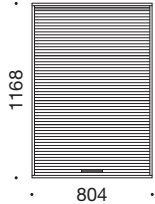
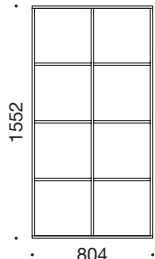
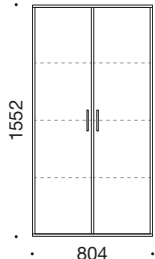
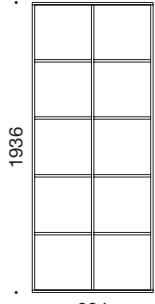
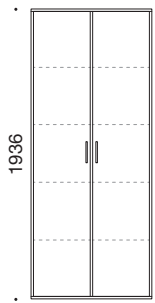
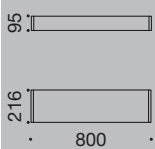
 <p>1168 804</p>	<p><b>Roll front cabinet, D 430 mm</b></p> <p>5362 Roll front cabinet - 965 1.159</p> <p>It is possible to install up to 2 pcs. suspension file frame (5519). Inside view; see model 5321. Note, not available with wall bracket. Fronts not available in Lindberg Oak.</p>
 <p>1552 804</p>	<p><b>Bookcase</b></p> <p>5323ECO Bookcase, D 350 mm 447 447 666</p> <p>5363ECO Bookcase, D 430 mm 529 529 765</p>
 <p>1552 804</p>	<p><b>Cabinet</b></p> <p>5379ECO Cabinet, D 350 mm 819 819 1.116</p> <p>5383ECO Cabinet, D 430 mm 901 901 1.215</p> <p>Note, 3 shelves behind each door.</p>
 <p>1936 804</p>	<p><b>Bookcase</b></p> <p>5325ECO Bookcase, D 350 mm 582 582 788</p> <p>5365ECO Bookcase, D 430 mm 644 644 862</p>
 <p>1936 804</p>	<p><b>Cabinet</b></p> <p>5384ECO Cabinet, D 350 mm 1.004 1.004 1.298</p> <p>5386ECO Cabinet, D 430 mm 1.066 1.066 1.372</p> <p>Note, 4 shelves behind each door.</p>
 <p>95 216 800</p>	<p><b>Plinths, 2-room wide</b></p> <p>5411ECO Low plinth for D 350 (H95xW800xD310mm) 76 76 90</p> <p>5412ECO Low plinth for D 430 (H95xW800xD390mm) 76 76 90</p> <p>5414ECO High plinth for D 350 (H216xW800xD310mm) 122 122 146</p> <p>5413ECO High plinth for D 430 (H216xW800xD390mm) 122 122 146</p>

Prices in EURO

Laminate : Opaque White, Montana Grey, Platinum Grey, Anthracite Grey, Slate Grey, Volcanic Black or Lindberg Oak.  
Veneer : ash, beech, maple or oak + 25% surcharge for walnut

# QUADRO Storage

**EU Ecolabel  
product in  
laminate**
**Laminate**
**Veneer**

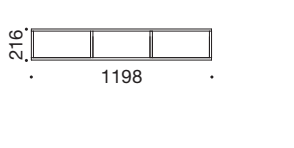
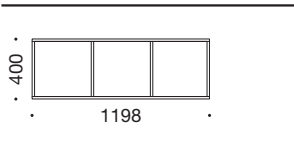
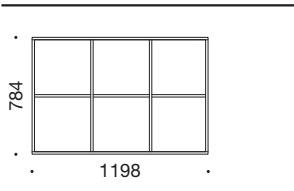
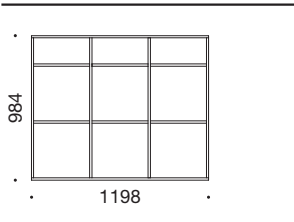
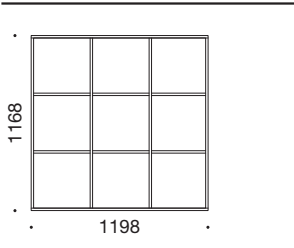
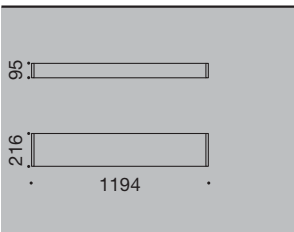
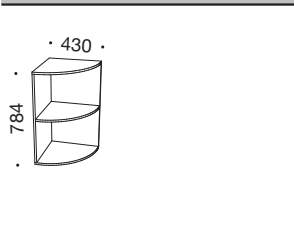
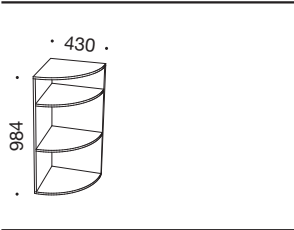
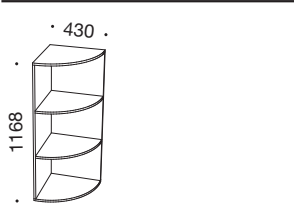
	<p><b>Bookcase</b></p> <p>5423 Bookcase, D 350 mm - 260 313</p> <p>5432 Bookcase, D 430 mm - 270 327</p>
	<p><b>Bookcase</b></p> <p>5330<sup>ECO</sup> Bookcase, D 350 mm 260 260 313</p> <p>5370<sup>ECO</sup> Bookcase, D 430 mm 270 270 327</p>
	<p><b>Bookcase</b></p> <p>5331<sup>ECO</sup> Bookcase, D 350 mm 446 446 549</p> <p>5371<sup>ECO</sup> Bookcase, D 430 mm 464 464 569</p>
	<p><b>Bookcase</b></p> <p>5336<sup>ECO</sup> Bookcase, D 350 mm 726 726 872</p> <p>5372<sup>ECO</sup> Bookcase, D 430 mm 786 786 946</p>
	<p><b>Bookcase</b></p> <p>5337<sup>ECO</sup> Bookcase, D 350 mm 726 726 872</p> <p>5377<sup>ECO</sup> Bookcase, D 430 mm 786 786 946</p>
	<p><b>Plinths, 3-room wide</b></p> <p>5431<sup>ECO</sup> Low plinth for D 350 (H95xW1194xD310mm) 93 93 113</p> <p>5435<sup>ECO</sup> Low plinth for D 430 (H95xW1194xD390mm) 93 93 113</p> <p>5433<sup>ECO</sup> High plinth for D 350 (H216xW1194xD310mm) 137 137 165</p> <p>5437<sup>ECO</sup> High plinth for D 430 (H216xW1194xD390mm) 137 137 165</p>
	<p><b>Corner bookcase, 2-room high</b></p> <p>5339 Corner bookcase, 90 degrees, D 350 mm - 641 767</p> <p>5340 Corner bookcase, 90 degrees, D 430 mm - 641 767</p> <p>5334 Corner bookcase, 45 degrees, D 350 mm - 641 767</p> <p>5341 Corner bookcase, 45 degrees, D 430 mm - 641 767</p>
	<p><b>Corner bookcase, 2½-room high</b></p> <p>5368 Corner bookcase, 90 degrees, D 350 mm - 689 827</p> <p>5374 Corner bookcase, 90 degrees, D 430 mm - 689 827</p> <p>5367 Corner bookcase, 45 degrees, D 350 mm - 689 827</p> <p>5369 Corner bookcase, 45 degrees, D 430 mm - 689 827</p>
	<p><b>Corner bookcase, 3-room high</b></p> <p>5338 Corner bookcase, 90 degrees, D 350 mm - 689 827</p> <p>5349 Corner bookcase, 90 degrees, D 430 mm - 689 827</p> <p>5335 Corner bookcase, 45 degrees, D 350 mm - 689 827</p> <p>5350 Corner bookcase, 45 degrees, D 430 mm - 689 827</p>

Prices in EURO

 Laminate : Opaque White, Montana Grey, Platinum Grey, Anthracite Grey, Slate Grey, Volcanic Black or Lindberg Oak.  
 Veneer : ash, beech, maple or oak + 25% surcharge for walnut

# QUADRO Flower box

**Laminate**
**Veneer**

		<b>Plinths for corner bookcases</b>			
	<b>5409</b>	5409	Plinth H 95 mm, 90 degrees, D 350 mm	158	189
	<b>5416</b>	5405	Plinth H 95 mm, 90 degrees, D 430 mm	158	189
		5416	High plinth H 216 mm, 90 degrees, D 350 mm	212	256
		5407	High plinth H 216 mm, 90 degrees, D 430 mm	212	256
	<b>5406</b>	5410	Plinth H 95 mm, 45 degrees, D 350 mm	158	189
	<b>5408</b>	5406	Plinth H 95 mm, 45 degrees, D 430 mm	158	189
		5417	High plinth H 216 mm, 45 degrees, D 350 mm	212	256
		5408	High plinth H 216 mm, 45 degrees, D 430 mm	212	256

					<b>Laminate</b>	<b>Veneer Nordic Nature</b>
		<b>Flower box <u>without</u> plastic liner for bookcases</b>				
	5218	Flower box without plastic liner, D 350 mm H 280 x W 410 x D 350 mm		162	207	
	5219	Flower box without plastic liner, D 430 mm H 280 x W 410 x D 430 mm		162	207	
	5220	Flower box without plastic liner, D 350 mm H 280 x W 804 x D 350 mm		288	349	
	5221	Flower box without plastic liner, D 430 mm H 280 x W 804 x D 430 mm		288	349	
	5228	Flower box without plastic liner, D 350 mm H 280 x W 1198 x D 350 mm		342	404	
	5229	Flower box without plastic liner, D 430 mm H 280 x W 1198 x D 430 mm		342	404	

					<b>Price</b>
		<b>Surcharge</b>			
5428	Bookcase without divider, 1-3 room high				86
5429	Cabinet without divider, 1-3 room high				115
5553	Fronts with linoleum or XP laminate, per 1-3 room high door / drawer insert				34
5575	Fronts with linoleum or XP laminate, per 4-5 room high door				67
5559	Top of bookcase with XP mat laminate or linoleum, per bookcase				133
5469	Assembly bracket for top plate (bone), set of 2 pcs.				58



# QUADRO Top plates





**HPL Veneer**      **Linoleum XP laminate**

		HPL Veneer	Linoleum XP laminate	
<b>Depth 350 mm top plates with bevelled edge</b>				
	5490	Top plate for width 410 mm H 23 mm x L 460 mm x D 400 mm	92      178	
	5491	Top plate for width 804 mm H 23 mm x L 854 mm x D 400 mm	107      193	
	5489	Top plate for width 1198 mm H 23 mm x L 1248 mm x D 400 mm	181      319	
	5492	Top plate for width 1608 mm H 23 mm x L 1658 mm x D 400 mm	279      416	
	5493	Top plate for width 2412 mm H 23 mm x L 2462 mm x D 400 mm	311      481	
	5487	Top plate for width 3216 mm H 23 mm x L 3266 mm x D 400 mm	557      832	
	<b>Depth 700 mm top plates with bevelled edge</b>			
	5452	Top plate for width 804 mm H 23 mm x L 854 mm x D 750 mm	148      211	
	5453	Top plate for width 1608 mm H 23 mm x L 1658 mm x D 750 mm	307      456	
	5454	Top plate for width 2412 mm H 23 mm x L 2462 mm x D 750 mm	341      528	
<b>Depth 430 mm top plates with bevelled edge</b>				
	5495	Top plate for width 410 mm H 23 mm x L 460 mm x D 480 mm	92      178	
	5496	Top plate for width 804 mm H 23 mm x L 854 mm x D 480 mm	107      193	
	5499	Top plate for width 1198 mm H 23 mm x L 1248 mm x D 480 mm	181      319	
	5497	Top plate for width 1608 mm H 23 mm x L 1658 mm x D 480 mm	279      416	
	5498	Top plate for width 2412 mm H 23 mm x L 2462 mm x D 480 mm	311      481	
	5488	Top plate for width 3216 mm H 23 mm x L 3266 mm x D 480 mm	557      832	
	<b>Depth 860 mm top plates with bevelled edge</b>			
		5457	Top plate for width 804 mm H 23 mm x L 854 mm x D 910 mm	250      321
5458		Top plate for width 1608 mm H 23 mm x L 1658 mm x D 910 mm	337      501	
5459		Top plate for width 2412 mm H 23 mm x L 2462 mm x D 910 mm	375      581	
<b>Spacer for top plates</b>				
	5415	Alu-spacer - 100 mm, 1 pcs.	41	

Prices in EURO

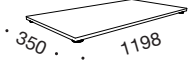
# QUADRO Storage

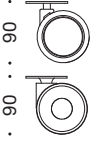
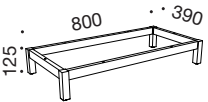
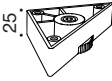
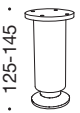
**EU Ecolabel  
product in  
laminate**
**Laminate**
**Veneer**

 <p>350 1198</p>	<p><b>Adjustable plate plinth, H 22 mm</b></p> <table border="0"> <tr> <td>5394</td> <td>ECO</td> <td>Plate plinth, H22 x W410 x D350 mm</td> <td>43</td> <td>43</td> <td>48</td> </tr> <tr> <td>5395</td> <td>ECO</td> <td>Plate plinth, H22 x W410 x D430 mm</td> <td>43</td> <td>43</td> <td>48</td> </tr> <tr> <td>5396</td> <td>ECO</td> <td>Plate plinth, H22 x W804 x D350 mm</td> <td>43</td> <td>43</td> <td>48</td> </tr> <tr> <td>5397</td> <td>ECO</td> <td>Plate plinth, H22 x W804 x D430 mm</td> <td>43</td> <td>43</td> <td>48</td> </tr> <tr> <td>5398</td> <td>ECO</td> <td>Plate plinth, H22 x W1198 x D350 mm</td> <td>43</td> <td>43</td> <td>48</td> </tr> <tr> <td>5399</td> <td>ECO</td> <td>Plate plinth, H22 x W1198 x D430 mm</td> <td>43</td> <td>43</td> <td>48</td> </tr> </table> <p>Not recommended if several racks are to stand next to each other.</p>	5394	ECO	Plate plinth, H22 x W410 x D350 mm	43	43	48	5395	ECO	Plate plinth, H22 x W410 x D430 mm	43	43	48	5396	ECO	Plate plinth, H22 x W804 x D350 mm	43	43	48	5397	ECO	Plate plinth, H22 x W804 x D430 mm	43	43	48	5398	ECO	Plate plinth, H22 x W1198 x D350 mm	43	43	48	5399	ECO	Plate plinth, H22 x W1198 x D430 mm	43	43	48
5394	ECO	Plate plinth, H22 x W410 x D350 mm	43	43	48																																
5395	ECO	Plate plinth, H22 x W410 x D430 mm	43	43	48																																
5396	ECO	Plate plinth, H22 x W804 x D350 mm	43	43	48																																
5397	ECO	Plate plinth, H22 x W804 x D430 mm	43	43	48																																
5398	ECO	Plate plinth, H22 x W1198 x D350 mm	43	43	48																																
5399	ECO	Plate plinth, H22 x W1198 x D430 mm	43	43	48																																
	<p><b>Wall bracket</b></p> <table border="0"> <tr> <td></td> <td></td> <td></td> <td></td> <td></td> <td><b>Price</b></td> </tr> <tr> <td>5525</td> <td></td> <td>Wall bracket (only for 1-room high cabinets)</td> <td></td> <td></td> <td>57</td> </tr> <tr> <td>5530</td> <td></td> <td>Wall bracket with extra support</td> <td></td> <td></td> <td>103</td> </tr> <tr> <td>5522</td> <td></td> <td>Double wall bracket (for large cabinets, see item no. below)</td> <td></td> <td></td> <td>113</td> </tr> </table> <p>Wall brackets for storage <u>without dividers</u> is not possible.</p>						<b>Price</b>	5525		Wall bracket (only for 1-room high cabinets)			57	5530		Wall bracket with extra support			103	5522		Double wall bracket (for large cabinets, see item no. below)			113												
					<b>Price</b>																																
5525		Wall bracket (only for 1-room high cabinets)			57																																
5530		Wall bracket with extra support			103																																
5522		Double wall bracket (for large cabinets, see item no. below)			113																																
 <p>5527 5521 5572</p>	<p><b>Castor</b></p> <table border="0"> <tr> <td>5527</td> <td></td> <td>Standard castor (grey), 1 pcs.</td> <td></td> <td></td> <td>19</td> </tr> <tr> <td>5521</td> <td></td> <td>Castor with cover plate in Nordic Nature, 1 pcs.</td> <td></td> <td></td> <td>35</td> </tr> <tr> <td>5572</td> <td></td> <td>Castor with cover plate in white or black, 1 pcs.</td> <td></td> <td></td> <td>22</td> </tr> </table> <p>The castors are lockable. We recommend using 5 castors for width 1198 mm and 1608 mm.</p>	5527		Standard castor (grey), 1 pcs.			19	5521		Castor with cover plate in Nordic Nature, 1 pcs.			35	5572		Castor with cover plate in white or black, 1 pcs.			22																		
5527		Standard castor (grey), 1 pcs.			19																																
5521		Castor with cover plate in Nordic Nature, 1 pcs.			35																																
5572		Castor with cover plate in white or black, 1 pcs.			22																																
 <p>125 800 390</p>	<p><b>Leg plinth in black metal with adjustable shoes, D 430 mm</b></p> <table border="0"> <tr> <td>5480</td> <td></td> <td>Leg plinth, H 125 x W 406 x D 390 mm</td> <td></td> <td></td> <td>139</td> </tr> <tr> <td>5483</td> <td></td> <td>Leg plinth, H 125 x W 800 x D 310 mm</td> <td></td> <td></td> <td>148</td> </tr> <tr> <td>5481</td> <td></td> <td>Leg plinth, H 125 x W 800 x D 390 mm</td> <td></td> <td></td> <td>150</td> </tr> <tr> <td>5482</td> <td></td> <td>Leg plinth, H 125 x W 1194 x D 390 mm</td> <td></td> <td></td> <td>165</td> </tr> </table>	5480		Leg plinth, H 125 x W 406 x D 390 mm			139	5483		Leg plinth, H 125 x W 800 x D 310 mm			148	5481		Leg plinth, H 125 x W 800 x D 390 mm			150	5482		Leg plinth, H 125 x W 1194 x D 390 mm			165												
5480		Leg plinth, H 125 x W 406 x D 390 mm			139																																
5483		Leg plinth, H 125 x W 800 x D 310 mm			148																																
5481		Leg plinth, H 125 x W 800 x D 390 mm			150																																
5482		Leg plinth, H 125 x W 1194 x D 390 mm			165																																
 <p>25</p>	<p><b>Corner foot</b></p> <table border="0"> <tr> <td>5426</td> <td></td> <td>Adjustable plastic foot, 1 pcs.</td> <td></td> <td></td> <td>8</td> </tr> </table> <p>Adjust foot by using the enclosed umbraco key.</p>	5426		Adjustable plastic foot, 1 pcs.			8																														
5426		Adjustable plastic foot, 1 pcs.			8																																
 <p>125-145</p>	<p><b>Round legs</b></p> <table border="0"> <tr> <td>5420</td> <td></td> <td>Alu-leg with height adjustment 125-145 mm, 1 pcs.</td> <td></td> <td></td> <td>41</td> </tr> <tr> <td>5419</td> <td></td> <td>Alu-leg with height adjustment 180-200 mm, 1 pcs.</td> <td></td> <td></td> <td>60</td> </tr> </table> <p>We recommend using 5 legs for module in width 1198 mm and 1608 mm.</p>	5420		Alu-leg with height adjustment 125-145 mm, 1 pcs.			41	5419		Alu-leg with height adjustment 180-200 mm, 1 pcs.			60																								
5420		Alu-leg with height adjustment 125-145 mm, 1 pcs.			41																																
5419		Alu-leg with height adjustment 180-200 mm, 1 pcs.			60																																
 <p>92</p>	<p><b>Square legs</b></p> <table border="0"> <tr> <td>5418</td> <td></td> <td>Square legs in steel with adjustable foot, 1 pcs.</td> <td></td> <td></td> <td>19</td> </tr> </table> <p>We recommend using 5 legs for module in width 804 mm, 1198 mm and 1608 mm.</p>	5418		Square legs in steel with adjustable foot, 1 pcs.			19																														
5418		Square legs in steel with adjustable foot, 1 pcs.			19																																

# QUADRO Plinth

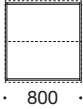
**EU Ecolabel  
product in  
laminate**
**Laminate**
**Veneer**

**Plinth for 2x 2-room wide, back to back**

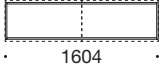
3151 <b>ECO</b>	Low plinth, 2x D 350 (H95xW800xD660mm)	153	153	180
3152 <b>ECO</b>	Low plinth, 2x D 430 (H95xW800xD820mm)	153	153	180
3153 <b>ECO</b>	High plinth, 2x D 350 (H216xW800xD660mm)	242	242	291
3154 <b>ECO</b>	High plinth, 2x D 430 (H216xW800xD820mm)	242	242	291

**Plinth for 2x 2-room wide, side by side**

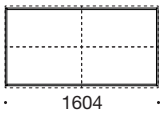
3155 <b>ECO</b>	Low plinth, D 350 (H95xW1604xD310mm)	183	183	217
3156 <b>ECO</b>	Low plinth, D 430 (H95xW1604xD390mm)	183	183	217
3157 <b>ECO</b>	High plinth, D 350 (H216xW1604xD310mm)	291	291	347
3158 <b>ECO</b>	High plinth, D 430 (H216xW1604xD390mm)	291	291	347

**Plinth for 4x 2-room wide, back to back**

3161 <b>ECO</b>	Low plinth, 2x D 350 (H95xW1604xD660mm)	314	314	370
3162 <b>ECO</b>	Low plinth, 2x D 430 (H95xW1604xD820mm)	314	314	370
3163 <b>ECO</b>	High plinth, 2x D 350 (H216xW1604xD660mm)	486	486	590
3164 <b>ECO</b>	High plinth, 2x D 430 (H216xW1604xD820mm)	486	486	590

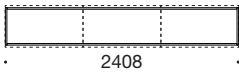
**Plinth for 3x 2-room wide, side by side**

3165 <b>ECO</b>	Low plinth, D 350 (H95xW2408xD310mm)	314	314	370
3166 <b>ECO</b>	Low plinth, D 430 (H95xW2408xD390mm)	314	314	370
3167 <b>ECO</b>	High plinth, D 350 (H216xW2408xD310mm)	486	486	590
3168 <b>ECO</b>	High plinth, D 430 (H216xW2408xD390mm)	486	486	590

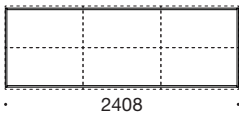
**Plinth for 6x 2-room wide, back to back**

3171 <b>ECO</b>	Low plinth, 2x D 350 (H95xW2408xD660mm)	407	407	479
3172 <b>ECO</b>	Low plinth, 2x D 430 (H95xW2408xD820mm)	407	407	479
3173 <b>ECO</b>	High plinth, 2x D 350 (H216xW2408xD660mm)	631	631	767
3174 <b>ECO</b>	High plinth, 2x D 430 (H216xW2408xD820mm)	631	631	767

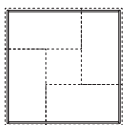
**Plinth for 4x 2-room wide, square**

3175 <b>ECO</b>	Low plinth, D 350 (H95xW1114xD1114mm)	314	314	370
3176 <b>ECO</b>	Low plinth, D 430 (H95xW1114xD1194mm)	314	314	370
3177 <b>ECO</b>	High plinth, D 350 (H216xW1114xD1114mm)	486	486	590
3178 <b>ECO</b>	High plinth, D 430 (H216xW1114xD1194mm)	486	486	590

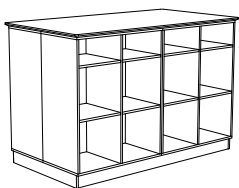
**Price example with top plate and plinth**

H 1102 mm x L 1658 mm x D 910 mm

5458	Top plate
5355	4 x bookcase
3162	Plinth, H 95 mm

Total price	-	2.400	2.968
-------------	---	-------	-------

# QUADRO Accessories



Laminate, Veneer Nordic Nature Linoleum XP laminate

	<b>Drawer insert for 1/2-room height</b>			
	5567	Insert with drawer D 350 mm	128	162
	5568	Insert with drawer D 430 mm	128	162
	5565	Insert with 2 drawers D 350 mm	174	208
	5566	Insert with 2 drawers D 430 mm	174	208
	Lock only fitted in the top drawer (accessory).			
	<b>Drawer insert</b>			
	5504	Insert with 4 drawers D 350 mm	333	367
	5514	Insert with 4 drawers D 430 mm	333	367
	5502	Insert with 3 drawers D 350 mm	274	307
	5512	Insert with 3 drawers D 430 mm	274	307
	5503	Insert with 2 drawers D 350 mm	241	275
	5513	Insert with 2 drawers D 430 mm	241	275
	5230	Insert with 1 drawer D 350 mm	297	331
	5232	Insert with 1 drawer D 430 mm	297	331
	5574	Suspension file with front D 350 mm	183	217
	5515	Suspension file with front D 430 mm	183	217
	5519	Suspension file without front D 430 mm (fits inside a roll front cabinet)	153	
	5511	Sloping document tray with 4 compartments for 1/2-room drawer with D 430 mm (can not be retrofitted)	80	80
	Lock only fitted in the top drawer (accessory).			
	<b>Letter trays in wood for 1/2-room height</b>			<b>Clear lacquer/ colored lacquer</b>
	5569	Insert with 3 trays D 350 mm		251
	5570	Insert with 3 trays D 430 mm		251
	<b>Letter trays in wood</b>			
	5517	Insert with 6 trays D 350 mm		450
	5518	Insert with 6 trays D 430 mm		450
	<b>Lemus speaker, built-in</b>			<b>Price</b>
5107	Lemus speaker, built-in (can not be retrofitted)		1.506	
	Upholstry : Twist Melange (Gabriel) - 60004 / 60011			
	High Definition 24bit / 192Khz			
	Amplifier : 4-channel HiFi, 300 watt RMS			
	Frequency response : 15-25.000 Hz +/- 3dB			
	Powerfull Quard-Core DSP			
	Room correction via Lemus HOME iOS-app			
	HDMI (ARC), Wi-Fi			
	Spotify-connect, Tidal, DLNA UPnP, Google Cast Audio,			
	Google Cast (multiroom), Apple Airplay 2, Bluetooth			

Prices in EURO

# QUADRO Accessories

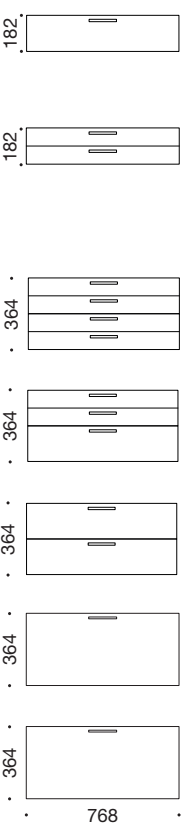
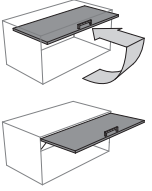
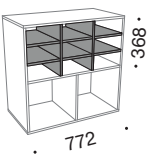
Laminate, Veneer  
 Nordic Nature      Linoleum  
 XP laminate

 <p>182</p> <p>182</p> <p>364</p> <p>364</p> <p>364</p> <p>364</p> <p>364</p> <p>364</p> <p>768</p>	<p><b>Wide drawer insert for 1/2-room height</b></p> <p>5244 Wide insert with drawer D 350 mm</p> <p>5246 Wide insert with drawer D 430 mm</p> <p>5240 Wide insert with 2 drawers D 350 mm</p> <p>5242 Wide insert with 2 drawers D 430 mm</p> <p><b>Wide drawer insert for 1-room height</b></p> <p>5248 Wide insert with 4 drawers D 350 mm</p> <p>5250 Wide insert with 4 drawers D 430 mm</p> <p>5252 Wide insert with 3 drawers D 350 mm</p> <p>5254 Wide insert with 3 drawers D 430 mm</p> <p>5256 Wide insert with 2 drawers D 350 mm</p> <p>5258 Wide insert with 2 drawers D 430 mm</p> <p>5260 Wide insert with 1 drawer D 350 mm</p> <p>5262 Wide insert with 1 drawer D 430 mm</p> <p>5516 Maxi suspension file with front, D 430 mm</p> <p>Lock only fitted in the top drawer (accessory).</p>	<p>171</p> <p>171</p> <p>230</p> <p>230</p> <p>442</p> <p>442</p> <p>365</p> <p>365</p> <p>303</p> <p>303</p> <p>405</p> <p>405</p> <p>471</p>	<p>205</p> <p>205</p> <p>265</p> <p>265</p> <p>477</p> <p>477</p> <p>398</p> <p>398</p> <p>337</p> <p>337</p> <p>439</p> <p>439</p> <p>506</p>
	 <p><b>Top-hung door</b></p> <p>5520 Top hung door that slides into the cabinet          W 768 x D 430 mm</p> <p>5573 Top hung door with gas lift</p> <p>Note that a push bracket is not an option for top-hung doors.</p>	<p>475</p> <p>228</p>	<p>509</p> <p>261</p>
	 <p><b>Mail sorting shelf</b></p> <p>5535 Mail sorting shelf, D 350 mm</p> <p>5537 Mail sorting shelf, D 430 mm</p> <p>Mail sorting shelf can be retrofitted in : 5327 / 5321 / 5310 / 5320.</p>	<p>178</p> <p>178</p>	<p><b>Price</b></p> <p>178</p> <p>178</p>
	 <p><b>Cushion with non-slip bottom</b></p> <p><b>2-room wide</b></p> <p>3581 Cushion, H 50 mm x W 804 mm x D 350 mm</p> <p>3582 Cushion, H 50 mm x W 804 mm x D 430 mm</p> <p><b>3-room wide</b></p> <p>3583 Cushion, H 50 mm x W 1198 mm x D 350 mm</p> <p>3584 Cushion, H 50 mm x W 1198 mm x D 430 mm</p> <p>Upholstred with Cura fabric from Gabriel.</p>	<p>298</p> <p>298</p> <p>440</p> <p>440</p>	<p>298</p> <p>298</p> <p>440</p> <p>440</p>

Prices in EURO

# QUADRO Doors

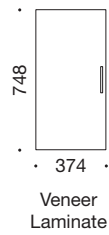
**Laminate  
Nordic Nature**
**Veneer**
**Linoleum  
XP laminate**
**Glass :  
Clear  
Mat**

**Doors, 1-room wide**

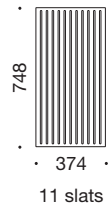
		Laminate Nordic Nature	Veneer	Linoleum XP laminate	Glass : Clear Mat
5580	Door, 1-room high, H 364 x W 374 mm	80	94	113	94
5582	Door, 1½-room high, H 564 x W 374 mm	95	122	130	122
5581	Door, 2-room high, H 748 x W 374 mm	112	145	146	145
5584	Door, 2½-room high, H 948 x W 374 mm	139	169	174	169
5585	Door, 3-room high, H 1132 x W 374 mm	167	200	200	200
5586	Door, 4-room high, H 1516 x W 374 mm	186	225	257	-
5587	Door, 5-room high, H 1899 x W 374 mm	211	255	282	-



**Doors with 11 slats, 1-room wide**

		Laminate Nordic Nature	Veneer	XP laminate
5580L	Door with slats, H 364 x W 374 mm		1.046	1.079
5582L	Door with slats, H 564 x W 374 mm		1.273	1.308
5581L	Door with slats, H 748 x W 374 mm		1.462	1.496
5584L	Door with slats, H 948 x W 374 mm		1.675	1.710
5585L	Door with slats, H 1132 x W 374 mm		1.952	1.985
5586L	Door with slats and handle, H 1516 x W 374 mm		2.161	2.232
5587L	Door with slats and handle, H 1899 x W 374 mm		2.406	2.477

Doors with slats are made in black or brown MDF. Please inform which color.

Handle placed 45 mm from the edge. Please inform where the handle should be placed.

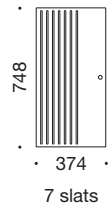
Only Flexlock and Cube Mifare locks can be used on this model.



**Doors with 7 slats, 1-room wide**

		Laminate Nordic Nature	Veneer	XP laminate
5780	Door with slats, H 364 x W 374 mm		1.046	1.079
5782	Door with slats, H 564 x W 374 mm		1.273	1.308
5781	Door with slats, H 748 x W 374 mm		1.462	1.496
5784	Door with slats, H 948 x W 374 mm		1.675	1.710
5785	Door with slats, H 1132 x W 374 mm		1.952	1.985
5786	Door with slats, H 1516 x W 374 mm		2.161	2.232
5787	Door with slats, H 1899 x W 374 mm		2.406	2.477

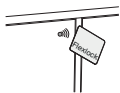
Doors with slats are made in black or brown MDF with knob handle as standard.

**Flexlock\* (Private Mode) (compatible with Mifare\*\*)**

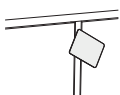
5140	Flexlock incl. mounted battery (available as accessories for Ecolabel products)			195
5142	User card for Flexlock, 1 pcs.			12
5143	Flexlock service card, 1 pcs.			27
5144	Flexlock programming card, 1 pcs.			27
5148	Flexlock Any User card (Public Mode), 1 pcs.			46
5149	Flexlock battery (extra), 1 pcs.			9

**Cube Mifare lock (Mifare Classic EV1 - EM4102 / Mifare Classic), standard with push**

5112	<b>Cube Mifare lock incl. 1 battery, 1 user card, 1 user fob</b>			130
5113	Cube Mifare user card, 1 pcs.			24
5114	Cube Mifare manager card, 1 pcs.			24
5115	Cube Mifare user fob, 1 pcs.			24

Veneer : ash, beech, maple or oak + 25% surcharge for walnut

\* To prolong battery life, we recommend doors are hinged on the same side when using electronic locks.



\*\* Mifare : 13,56 MHz : Mifare Classic 1k, Mifare Classic 4k, Mifare DESFire EV1 & EV

Prices in EURO



# QUADRO Accessories

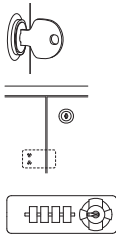
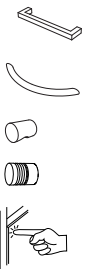
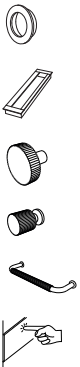
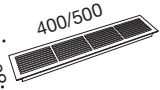



**Price**

	<p><b>Locks</b></p> <table border="0"> <tr> <td>5120</td> <td>Lock, right door</td> <td>41</td> </tr> <tr> <td>5139</td> <td>Lock, left door, drawers and pull out cabinets</td> <td>41</td> </tr> <tr> <td></td> <td>Lock for cabinet without divider (Mounted in the right door)</td> <td>53</td> </tr> <tr> <td></td> <td>Hole for lock in glass door - <u>only</u> hole</td> <td>17</td> </tr> <tr> <td></td> <td>Hole for lock for RUKO lock in standard door - <u>only</u> hole</td> <td>7</td> </tr> <tr> <td></td> <td>Combination lock public mode (black), right door - can not be retrofitted</td> <td>48</td> </tr> <tr> <td></td> <td>Combination lock public mode (black), left door - can not be retrofitted</td> <td>48</td> </tr> <tr> <td></td> <td>Combination lock for regular users (black), right door - can not be retrofitted</td> <td>48</td> </tr> <tr> <td></td> <td>Combination lock for regular users (black), left door - can not be retrofitted</td> <td>48</td> </tr> <tr> <td></td> <td>Lock for roll front cabinet</td> <td>41</td> </tr> <tr> <td></td> <td>Master Key</td> <td>25</td> </tr> </table>	5120	Lock, right door	41	5139	Lock, left door, drawers and pull out cabinets	41		Lock for cabinet without divider (Mounted in the right door)	53		Hole for lock in glass door - <u>only</u> hole	17		Hole for lock for RUKO lock in standard door - <u>only</u> hole	7		Combination lock public mode (black), right door - can not be retrofitted	48		Combination lock public mode (black), left door - can not be retrofitted	48		Combination lock for regular users (black), right door - can not be retrofitted	48		Combination lock for regular users (black), left door - can not be retrofitted	48		Lock for roll front cabinet	41		Master Key	25
5120	Lock, right door	41																																
5139	Lock, left door, drawers and pull out cabinets	41																																
	Lock for cabinet without divider (Mounted in the right door)	53																																
	Hole for lock in glass door - <u>only</u> hole	17																																
	Hole for lock for RUKO lock in standard door - <u>only</u> hole	7																																
	Combination lock public mode (black), right door - can not be retrofitted	48																																
	Combination lock public mode (black), left door - can not be retrofitted	48																																
	Combination lock for regular users (black), right door - can not be retrofitted	48																																
	Combination lock for regular users (black), left door - can not be retrofitted	48																																
	Lock for roll front cabinet	41																																
	Master Key	25																																
<p><b>Handles</b></p> 	<p><b>Handles <u>without</u> surcharge</b> (Choose freely between these handles - all fronts are with handles)</p> <table border="0"> <tr> <td>5450</td> <td>Quadro handle in white, black, polished chrome, brass or mat chrome (Standard handle in mat chrome, unless otherwise stated)*</td> <td></td> </tr> <tr> <td>9531</td> <td>Mosaik handle, mat chrome</td> <td></td> </tr> <tr> <td>5451</td> <td>Knob handle in white, brass, black, mat chrome or polished chrome</td> <td></td> </tr> <tr> <td>5456</td> <td>Knob handle with grooves</td> <td></td> </tr> <tr> <td>5465</td> <td>Push bracket for door (Not for storage with castors)</td> <td></td> </tr> <tr> <td></td> <td>Extra handle, 1 pcs.</td> <td>8</td> </tr> </table> <p>*Available as accessories for Ecolabel products. Choose between white, black, or mat chrome.</p>	5450	Quadro handle in white, black, polished chrome, brass or mat chrome (Standard handle in mat chrome, unless otherwise stated)*		9531	Mosaik handle, mat chrome		5451	Knob handle in white, brass, black, mat chrome or polished chrome		5456	Knob handle with grooves		5465	Push bracket for door (Not for storage with castors)			Extra handle, 1 pcs.	8															
5450	Quadro handle in white, black, polished chrome, brass or mat chrome (Standard handle in mat chrome, unless otherwise stated)*																																	
9531	Mosaik handle, mat chrome																																	
5451	Knob handle in white, brass, black, mat chrome or polished chrome																																	
5456	Knob handle with grooves																																	
5465	Push bracket for door (Not for storage with castors)																																	
	Extra handle, 1 pcs.	8																																
<p><b>Surcharge</b></p> 	<p><b>Handles <u>with</u> surcharge</b></p> <table border="0"> <tr> <td>5463</td> <td>Milled handle, Ø 50/40 mm in stainless steel, black or brass</td> <td>18</td> </tr> <tr> <td>5464</td> <td>Milled handle, 143 mm x 34 mm in alu, white, black or brass</td> <td>18</td> </tr> <tr> <td>5471</td> <td>Ribbed knob handle, Ø 30 mm, in solid brass. Color: black, stainless steel or brass</td> <td>16</td> </tr> <tr> <td>5472</td> <td>Ribbed knob handle, Ø 16 mm, in solid brass. Color: black, stainless steel or brass</td> <td>13</td> </tr> <tr> <td>5473</td> <td>Ribbed handle, 128 mm, in solid brass. Color: black, stainless steel or brass</td> <td>27</td> </tr> <tr> <td>5466</td> <td>Push bracket for drawers, 1 drawer</td> <td>12</td> </tr> </table>	5463	Milled handle, Ø 50/40 mm in stainless steel, black or brass	18	5464	Milled handle, 143 mm x 34 mm in alu, white, black or brass	18	5471	Ribbed knob handle, Ø 30 mm, in solid brass. Color: black, stainless steel or brass	16	5472	Ribbed knob handle, Ø 16 mm, in solid brass. Color: black, stainless steel or brass	13	5473	Ribbed handle, 128 mm, in solid brass. Color: black, stainless steel or brass	27	5466	Push bracket for drawers, 1 drawer	12															
5463	Milled handle, Ø 50/40 mm in stainless steel, black or brass	18																																
5464	Milled handle, 143 mm x 34 mm in alu, white, black or brass	18																																
5471	Ribbed knob handle, Ø 30 mm, in solid brass. Color: black, stainless steel or brass	16																																
5472	Ribbed knob handle, Ø 16 mm, in solid brass. Color: black, stainless steel or brass	13																																
5473	Ribbed handle, 128 mm, in solid brass. Color: black, stainless steel or brass	27																																
5466	Push bracket for drawers, 1 drawer	12																																
	<p><b>Ventilationgrate in aluminium</b></p> <table border="0"> <tr> <td>9532</td> <td><b>Ventilation grate for computers / refrigerator etc., L 400 x W 86 mm</b></td> <td><b>82</b></td> </tr> <tr> <td>9533</td> <td><b>Ventilation grate for computers / refrigerator etc., L 500 x W 86 mm</b></td> <td><b>82</b></td> </tr> <tr> <td>9534</td> <td>Ventilation grate for computers / refrigerator etc., L 240 x W 78 mm</td> <td>82</td> </tr> </table> <p>We recommend using 2 grates - one in the side of the cabinet and one at the bottom.</p>	9532	<b>Ventilation grate for computers / refrigerator etc., L 400 x W 86 mm</b>	<b>82</b>	9533	<b>Ventilation grate for computers / refrigerator etc., L 500 x W 86 mm</b>	<b>82</b>	9534	Ventilation grate for computers / refrigerator etc., L 240 x W 78 mm	82																								
9532	<b>Ventilation grate for computers / refrigerator etc., L 400 x W 86 mm</b>	<b>82</b>																																
9533	<b>Ventilation grate for computers / refrigerator etc., L 500 x W 86 mm</b>	<b>82</b>																																
9534	Ventilation grate for computers / refrigerator etc., L 240 x W 78 mm	82																																
	<p><b>Pen tray</b></p> <table border="0"> <tr> <td>5507</td> <td>Adjustable plastic tray</td> <td>10</td> </tr> </table>	5507	Adjustable plastic tray	10																														
5507	Adjustable plastic tray	10																																
	<p><b>Counterweight</b></p> <table border="0"> <tr> <td>5529</td> <td>Counterweight (approx. 6,5 kg)</td> <td>81</td> </tr> </table>	5529	Counterweight (approx. 6,5 kg)	81																														
5529	Counterweight (approx. 6,5 kg)	81																																

Prices in EURO



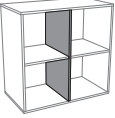

# QUADRO Accessories

Laminate Veneer Nordic Nature

	<p><b>Journal shelf for a bookcase</b></p> <p>5561 Journal shelf for D 350 mm W 378 x D 425 mm, 1 pcs. 90 109 116</p> <p>5548 Journal shelf for D 430 mm W 378 x D 491 mm, 1 pcs. 90 109 116</p>
	<p><b>Shelves, D 350 mm</b></p> <p>5540 Shelf for a bookcase 40 48 97</p> <p>5541 Shelf for a cabinet 40 48 97</p> <p>5542 Wide* shelf for a bookcase 107 125 137</p> <p>5543 Wide* shelf for a cabinet 107 125 137</p> <p>5576 Shelf for cabinet with glass door 40 48 97</p> <p><b>Shelves, D 430 mm</b></p> <p>5545 Shelf for a bookcase 40 48 97</p> <p>5546 Shelf for a cabinet 40 48 97</p> <p>5547 Shelf for a roll front cabinet 40 48 97</p> <p>5549 Pull-out shelf 193 230 274</p> <p>5564 Wide* pull-out shelf 221 264 307</p> <p>5550 Wide* shelf for a bookcase 107 128 137</p> <p>5552 Wide* shelf for a roll front cabinet 107 128 137</p> <p>5551 Wide* shelf for a cabinet 107 128 137</p> <p>5577 Shelf for cabinet with glass door 40 48 97</p> <p>5557 Shelf for a cabinet with push bracket 38 46 97</p> <p><b>Note, loose shelves are removable as standard.</b></p>
	<p><b>Metal rail for wide shelf</b></p> <p>5509 Metal rail for wide shelf, black metal 32</p> <p>Used when mounting drawers / doors in a cabinet without divider.</p>
	<p><b>Divider (accessory)</b></p> <p>5631 1-room high, D 350 mm 64 78 103</p> <p>5632 2-room high, D 350 mm 75 89 119</p> <p>5633 3-room high, D 350 mm 84 100 134</p> <p>5634 4-room high, D 350 mm 92 111 149</p> <p>5635 5-room high, D 350 mm 103 123 163</p> <p>5641 1-room high, D 430 mm 64 78 103</p> <p>5642 2-room high, D 430 mm 75 89 119</p> <p>5643 3-room high, D 430 mm 84 100 134</p> <p>5644 4-room high, D 430 mm 92 111 149</p> <p>5645 5-room high, D 430 mm 103 123 163</p>
	<p><b>Letter trays for depth 430 mm</b></p> <p>5510 A4 letter trays insert, black, 7 drawers 90 H 320 mm x W 250 mm x D 330 mm</p> <p>1 tray per shelf - without middle dividers 3 trays</p>

**QUADRO** Accessories

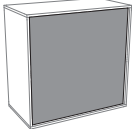
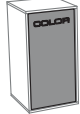
Price

	<p><b>Drawer insert A4 - Plastic</b></p> <p>5187     Drawer insert with 6 drawers, black plastic            H 365 mm x W 376 mm x D 240 mm</p> <p>Can be retrofitted in bookcases</p>	164
	<p><b>Drawer insert A4 - Steel</b></p> <p>5186     Drawer insert with 6 drawers in alu-coated steel            H 365 mm x W 376 mm x D 240 mm</p> <p>Can be retrofitted in bookcases</p>	
	<p><b>Bulletin board for mounting on the back of a cabinet</b></p> <p><b>2-room wide</b></p> <p>5538     1½-room high, H 564 x W 768 mm 5531     2-room high, H 748 x W 768 mm 5539     2½-room high, H 948 x W 768 mm 5532     3-room high, H 1132 x W 768 mm 5533     4-room high, H 1516 x W 768 mm</p> <p><b>3-room wide</b></p> <p>5692     2-room high, H 748 x W 1162 mm 5534     3-room high, H 1132 x W 1162</p> <p>Upholstered with Lucia (Camira), Cura (Gabriel) or black recycled rubber. Lucia fabric is suitable for bulletin boards and screens.</p>	<p>229 265 265 302 344  302 377</p>
<p><b>Surcharge</b></p>   	<p style="text-align: right;"><b>Nordic Nature     Whiteboard</b></p> <p><b>Nordic Nature (HPL) or whiteboard backing</b></p> <p><b>1-room wide</b></p> <p>5658     1-room high 5659     2-room high 5660     3-room high 5661     4-room high 5662     5-room high</p> <p><b>2-room wide</b></p> <p>5668     1-room high 5669     2-room high 5670     3-room high 5671     4-room high 5672     5-room high</p> <p><b>3-room wide</b></p> <p>5678     1-room high 5679     2-room high 5680     3-room high</p>	<p>78     141 129     204 162     235 195     346 227     393  129     204 172     330 215     362 258     582 302     629  162     235 215     362 267     393</p>

Prices in EURO

# QUADRO Back plates

Laminate  
Nordic Nature

Veneer XP laminate

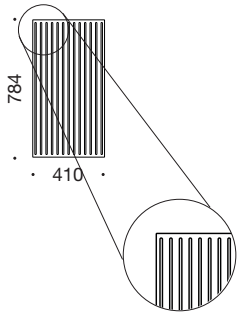

13 slats

### Quadro back plate with slats, 1-room wide

Product Code	Description	Laminate Nordic Nature	Veneer XP laminate
7001	Plate with slats, 1-room high, H 400 x W 410 mm	205	239
7002	Plate with slats, 1½-room high, H 600 x W 410 mm	228	262
7003	Plate with slats, 2-room high, H 784 x W 410 mm	280	319
7004	Plate with slats, 2½-room high, H 984 x W 410 mm	314	349
7005	Plate with slats, 3-room high, H 1168 x W 410 mm	351	390
7006	Plate with slats, 4-room high, H 1552 x W 410 mm	375	446
7007	Plate with slats, 5-room high, H 1936 x W 410 mm	438	509

Plates with slats are made in black or brown MDF. Please inform which color.  
Please note, there will be visible screws inside the backing when the plates are mounted on the back of the bookcase/cabinet.

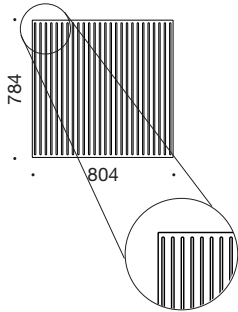

26 slats

### Quadro back plate with slats, 2-room wide

Product Code	Description	Laminate Nordic Nature	Veneer XP laminate
7011	Plate with slats, 1-room high, H 400 x B 804 mm	345	413
7012	Plate with slats, 1½-room high, H 600 x B 804 mm	304	459
7013	Plate with slats, 2-room high, H 784 x B 804 mm	463	531
7014	Plate with slats, 2½-room high, H 984 x B 804 mm	530	599
7015	Plate with slats, 3-room high, H 1168 x B 804 mm	603	679
7016	Plate with slats, 4-room high, H 1552 x B 804 mm	653	794
7017	Plate with slats, 5-room high, H 1936 x B 804 mm	747	887

Plates with slats are made in black or brown MDF. Please inform which color.  
Please note, there will be visible screws inside the backing when the plates are mounted on the back of the bookcase/cabinet.

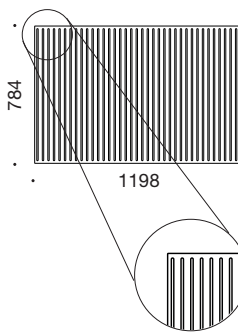

38 slats

### Quadro back plate with slats, 3-room wide

Product Code	Description	Laminate Nordic Nature	Veneer XP laminate
7021	Plate with slats, 1-room high, H 400 x B 1198 mm	503	614
7023	Plate with slats, 2-room high, H 784 x B 1198 mm	689	792
7024	Plate with slats, 2½-room high, H 984 x B 1198 mm	790	893
7025	Plate with slats, 3-room high, H 1168 x B 1198 mm	900	1.009

Plates with slats are made in black or brown MDF. Please inform which color.  
Please note, there will be visible screws inside the backing when the plates are mounted on the back of the bookcase/cabinet.

## QUADRO SLIDING DOOR



### Quadro sliding door cabinets in general :

- Sliding door cabinets in 16 mm plates
- 7 cabinet colors in laminate
- 5 cabinet colors in veneer
- 4 heights
- Depth 430 mm
- Back panel in 8 mm plates
- 2 mm impact-resistant ABS edge (laminate cabinet)
- 2 mm wooden edge (veneer cabinet)
- 33 colors in laminate - of which 20 are high pressure laminate
- Nordic Nature fronts in high pressure laminate
- Sliding door cabinet with milled handles in white, alu or black
- The right door is in front
- Delivered assembled
- 10 years warranty

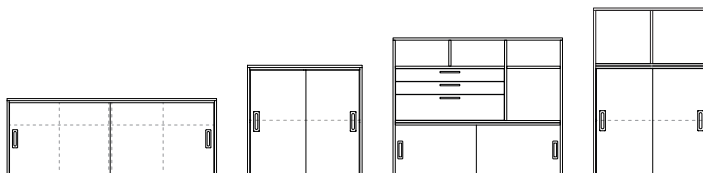

Cabinet available in :

- **Laminate** : Opaque White, Montana Grey, Platinum Grey, Anthracite Grey, Slate Grey, Volcanic Black, Lindberg Oak or Congo
- **Veneer** : ash, beech, maple, oak or walnut\*

The bookcases are delivered with laminate or veneer on back panel and can be used as dividers.

Surface - fronts :

- Standard laminate
- Nordic Nature (HPL)
- Veneer
- XP mat laminate\*
- Linoleum\*

Support :

- Plinth
- Plate plinth
- Leg plinth
- Legs

\* Note surcharge see page 34.

# QUADRO Sliding door cabinet

**Laminate**
**Veneer**

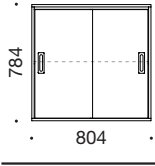
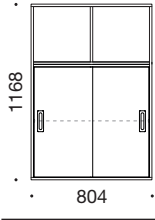
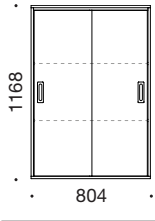
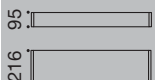
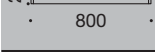
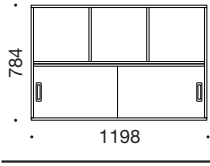
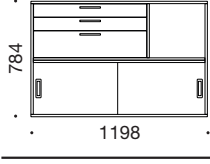
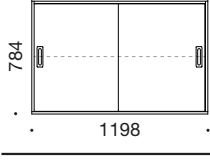
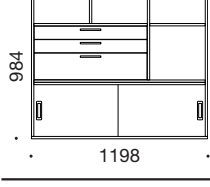
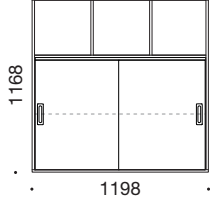
	<b>Sliding door cabinet <u>without</u> softclose, D 430 mm</b> 5296 Sliding door cabinet	605	715
	<b>Sliding door cabinet <u>without</u> softclose, D 430 mm</b> 5294 Sliding door cabinet	735	873
	<b>Sliding door cabinet <u>without</u> softclose, D 430 mm</b> 5295 Sliding door cabinet	741	869
 	<b>Plinths, 2-room wide</b> 5412 Low plinth for D 430 mm (H 95 x W 800 x D 390 mm) 5413 High plinth for D 430 mm (H 216 x W 800 x D 390 mm)	76 122	90 146
	<b>Sliding door cabinet <u>with</u> softclose, D 430 mm</b> 5291 Sliding door cabinet with softclose	987	1.185
	<b>Sliding door cabinet <u>with</u> softclose, D 430 mm</b> 5292 Sliding door cabinet with softclose	1.352	1.550
	<b>Sliding door cabinet <u>with</u> softclose, D 430 mm</b> 5373 Sliding door cabinet with softclose	987	1.185
	<b>Sliding door cabinet <u>with</u> softclose, D 430 mm</b> 5293 Sliding door cabinet with softclose	1.380	1.579
	<b>Sliding door cabinet <u>with</u> softclose, D 430 mm</b> 5290 Sliding door cabinet with softclose	1.196	1.436

Prices in EURO

 Laminate : Opaque White, Montana Grey, Platinum Grey, Anthracite Grey, Slate Grey, Volcanic Black or Lindberg Oak.  
 Veneer : ash, beech, maple or oak + 25% surcharge for walnut



# QUADRO Sliding door cabinet

Laminate



Veneer

	<p><b>Sliding door cabinet with softclose, D 430 mm</b>            5376 Sliding door cabinet with softclose</p>	<p>1.175</p>	<p>1.410</p>
	<p><b>Plinths, 3-room wide</b>            5435 Low plinth for D 430 mm (H 95 x W 1194 x D 390 mm)            5437 High plinth for D 430 mm (H 216 x W 1194 x D 390 mm)</p>	<p>93 137</p>	<p>113 165</p>
	<p><b>Sliding door cabinet with softclose, D 430 mm</b>            5375 Sliding door cabinet, 1½ room high (H 600 mm)</p>	<p>1.252</p>	<p>1.502</p>
	<p><b>Sliding door cabinet with softclose, D 430 mm</b>            5280 Sliding door cabinet, 2 rooms high (H 784 mm)</p>	<p>1.331</p>	<p>1.558</p>
	<p><b>Sliding door cabinet with softclose, D 430 mm</b>            5282 Sliding door cabinet, 3 rooms high (H 1168 mm)</p>	<p>1.530</p>	<p>1.759</p>
	<p><b>Plinths, 4-room wide</b>            3156 Low plinth, H 95 x W 1604 x D 390 mm            3158 High plinth, H 216 x W 1604 x D 390 mm</p>	<p>183 291</p>	<p>217 347</p>
	<p><b>Adjustable plate plinth, H 22 mm</b>            5395 Plate plinth, H 22 x W 410 x D 430 mm            5397 Plate plinth, H 22 x W 804 x D 430 mm            5399 Plate plinth, H 22 x W 1198 x D 430 mm            5275 Plate plinth, H 22 x W 1608 x D 430 mm</p> <p><b>Leg plinth in black metal with adjustable shoes, D 430 mm</b>            5481 Leg plinth, H 125 x W 800 x D 390 mm            5482 Leg plinth, H 125 x W 1194 x D 390 mm</p> <p><b>Legs and feet</b>            5426 Adjustable plastic foot, 1 pcs.            5420 Alu-leg with height adjustment 125-145 mm, 1 pcs.            5419 Alu-leg with height adjustment 180-200 mm, 1 pcs.            5418 Square legs in steel with adjustable foot, 1 pcs.</p> <p>We recommend using 5 legs for module in width 1198 mm and 1608 mm.</p>	<p>43 43 43 43</p>	<p>48 48 48 48</p> <p><b>Price</b> 165</p> <p>8 41 60 19</p>

Prices in EURO

# QUADRO Sliding door cabinet accessories

**Laminate**
**Veneer**

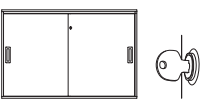
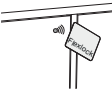
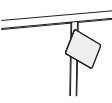
		Laminate	Veneer
<b>Surcharge / accessories</b>			
	5597 Extra shelf for sliding door cabinet (W 378 x D 339 mm)	38	46
	5598 Extra shelf for sliding door cabinet (W 575 x D 339 mm)	58	69
			<b>Price</b>
	5279 Soft close in sliding door cabinet W 804 mm, per sliding door cabinet		43
	5276 Fronts with linoleum or XP laminate, sliding door cabinet W 804 mm		64
	5277 Fronts with linoleum or XP laminate, sliding door cabinet W 1198 mm		72
	5278 Fronts with linoleum or XP laminate, sliding door cabinet W 1608 mm		86
	5559 Top of bookcase with XP mat laminate or linoleum, per bookcase		133
	<b>Drawer insert A4 - Plastic</b>		
	5510 A4 letter tray insert, 7 drawers, free-standing H 320 mm x W 250 mm x D 330 mm		90
	<b>Drawer insert A4 - Plastic</b>		
	5187 Drawer insert with 6 drawers, black plastic H 365 mm x W 376 mm x D 240 mm		164
	5621 Extra divider (Necessary) Can <u>not</u> be mounted at the upper shelf.		76
	<b>Drawer insert A4 - Steel</b>		
	5186 Drawer insert with 6 drawers in alu-coated steel H 365 mm x W 376 mm x D 240 mm		316
	5621 Extra divider (Necessary) Can <u>not</u> be mounted at the upper shelf.		76
	<b>Lock for sliding door cabinet</b>		
	5118 Lock for sliding door cabinet, 1 pcs.		43
	5145 Combination lock (black) for sliding door cabinet (regular users)		50
	<b>Flexlock (Private Mode)</b> (compatible with Mifare*)		
	5140 Flexlock incl. mounted battery		195
	5142 User card for Flexlock, 1 pcs.		12
	5143 Flexlock service card, 1 pcs.		27
	5144 Flexlock programming card, 1 pcs.		27
	5148 Flexlock Any User card (Public Mode), 1 pcs.		46
	5149 Flexlock battery (extra), 1. psc.		9
	<b>Cube Mifare lock*</b> (Mifare Classic EV1 - EM4102 / Mifare Classic), remember handle or push		
	<b>5112 Cube Mifare lock incl. 1 battery, 1 user card, 1 user fob</b>		130
	5113 Cube Mifare user card, 1 pcs.		24
	5114 Cube Mifare manager card, 1 pcs.		24
	5115 Cube Mifare user fob, 1 pcs.		24

Prices in EURO

\* Mifare : 13,56 MHz : Mifare Classic 1k, Mifare Classic 4k, Mifare DESFire EV1 &amp; EV2.

## QUADRO PULL-OUT CABINETS



Cabinet available in :

- **Laminate** : Opaque White, Montana Grey, Platinum Grey, Anthracite Grey, Slate Grey, Volcanic Black, Lindberg Oak or Congo
- **Veneer** : ash, beech, maple, oak or walnut\*

The bookcases are delivered with laminate or veneer on back panel and can be used as dividers.

Surface - fronts :

- Standard laminate
- Nordic Nature (HPL)
- Veneer
- XP mat laminate\*
- Linoleum\*

\* Note surcharge see page 37.

### Quadro pull-out cabinets in general :

- Pull-out cabinets in 16 mm plates
- 7 cabinet colors in laminate
- 5 cabinet colors in veneer
- 3 heights
- 2 depths: D 800 and D 900 mm
- Fully extendable in depth 900 mm
- Back panel in 16 mm plates
- 2 mm impact-resistant ABS edge (laminate cabinet)
- 2 mm wooden edge (veneer cabinet)
- 33 colors in laminate - of which 20 are high pressure laminate
- Nordic Nature fronts in high pressure laminate
- Soft close
- Standard handle in mat chrome, unless otherwise stated
- Delivered assembled - only handles are to be mounted
- EN16121+EN16122 tested
- 10 years warranty

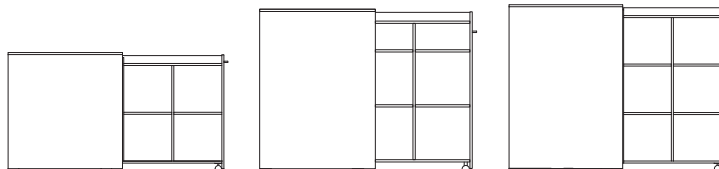

# QUADRO

 Pull-out cabinets

 EU Ecolabel  
 product in  
 laminate

Laminate

Veneer

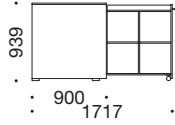
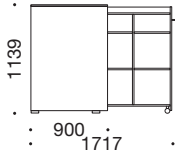
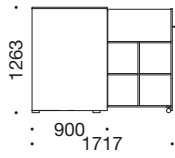
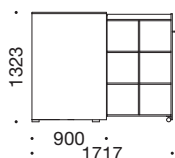
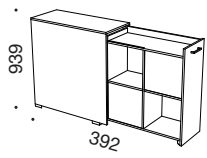
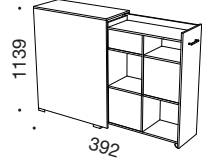
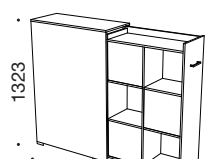
	<p><b>Pull-out cabinet - low</b></p> <p>5201<b>ECO</b> H 939 x W 392 x D 800 / 1470 mm</p> <p>5202<b>ECO</b> H 939 x W 392 x D 900 / 1615 mm</p> <p>Fully extendable in depth 900 mm. Please inform right / left when ordering (see illustration).</p>	<p>902</p> <p>902</p>	<p>902</p> <p>902</p>	<p>1.076</p> <p>1.076</p>
	<p><b>Pull-out cabinet - medium</b></p> <p>5198<b>ECO</b> H 1139 x W 392 x D 800 / 1470 mm</p> <p>5199<b>ECO</b> H 1139 x W 392 x D 900 / 1615 mm</p> <p>Fully extendable in depth 900 mm. Please inform right / left when ordering (see illustration).</p>	<p>930</p> <p>930</p>	<p>930</p> <p>930</p>	<p>1.117</p> <p>1.117</p>
	<p><b>Pull-out cabinet - high</b></p> <p>5183<b>ECO</b> H 1263 x W 392 x D 800 / 1470 mm</p> <p>5184<b>ECO</b> H 1263 x W 392 x D 900 / 1615 mm</p> <p>Fully extendable in depth 900 mm. Please inform right / left when ordering (see illustration).</p>	<p>930</p> <p>930</p>	<p>930</p> <p>930</p>	<p>1.117</p> <p>1.117</p>
	<p><b>Pull-out cabinet - high</b></p> <p>5203<b>ECO</b> H 1323 x W 392 x D 800 / 1470 mm</p> <p>5204<b>ECO</b> H 1323 x W 392 x D 900 / 1615 mm</p> <p>Fully extendable in depth 900 mm. Please inform right / left when ordering (see illustration).</p>	<p>955</p> <p>955</p>	<p>955</p> <p>955</p>	<p>1.142</p> <p>1.142</p>
	<p><b>Two-sided pull-out cabinet with shelving on both sides</b></p> <p>5208<b>ECO</b> Low two-sided pull-out cabinet H 939 x W 392 x D 900 / 1717 mm</p>	<p>955</p>	<p>955</p>	<p>1.181</p>
	<p><b>Two-sided pull-out cabinet with shelving on both sides</b></p> <p>5207<b>ECO</b> Medium two-sided pull-out cabinet H 1139 x W 392 x D 900 / 1717 mm</p>	<p>983</p>	<p>983</p>	<p>1.190</p>
	<p><b>Two-sided pull-out cabinet with shelving on both sides</b></p> <p>5209<b>ECO</b> High two-sided pull-out cabinet H 1323 x W 392 x D 900 / 1717 mm</p>	<p>1.007</p>	<p>1.007</p>	<p>1.205</p>

Prices in EURO

 Laminate : Opaque White, Montana Grey, Platinum Grey, Anthracite Grey, Slate Grey, Volcanic Black or Lindberg Oak.  
 Veneer : ash, beech, maple or oak + 25% surcharge for walnut

# QUADRO Accessories







Laminate Veneer  
Nordic Nature

	<p><b>Flower box <u>without</u> plastic liner for pull-out cabinets</b></p> <p>5210 Flower box without plastic liner, D 800 mm H 280 mm x W 392 mm x D 800 mm</p> <p>5214 Flower box without plastic liner, D 900 mm H 280 mm x W 392 mm x D 900 mm</p>	288	370
<p><b>Illustration</b></p> <p>A2 B1 Left A1 B2 Right</p>	<p><b>Please inform materials on :</b></p> <p>1 Cabinet 2 Inner cabinet 3 Front</p> <p>Please inform right / left when ordering (see illustration).</p>		
	<p><b>Surcharge / accessories</b></p> <p>5553 Fronts with XP mat laminate or linoleum</p> <p>5596 Colored inner cabinet (Nordic Nature (HPL))</p> <p>5579 Extra shelf for pull out cabinet (W 378 mm x D 326 mm)</p> <p>5578 Extra shelf for pull out cabinet (W 328 mm x D 326 mm)</p>	40	<b>Price</b> 34 205 48 48
<p>10 slats</p>	<p><b>Surcharge / accessories</b></p> <p>5002 Front with 10 slats, pull-out cabinet, low</p> <p>5003 Front with 10 slats, pull-out cabinet, medium</p> <p>5004 Front with 10 slats, pull-out cabinet, high</p> <p>Fronts with slats are made in black or brown MDF. Please inform which color.</p>		69 76 85
<p>5450</p> <p>9531</p>	<p><b>Handles <u>without</u> surcharge</b></p> <p>5450 Quadro handle in white, black, polished chrome, brass or mat chrom (Standard handle in mat chrome, unless otherwise stated)*</p> <p>9531 Mosaik handle, mat chrome</p> <p>Choose freely between these handles - all fronts are with handles. *Available as accessories for Ecolabel products. Choose between white, black, or mat chrome.</p>		
	<p><b>Lock for pull-out cabinet</b></p> <p>5120 Lock for pull-out cabinet, 1 pcs.</p>		41

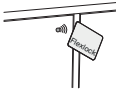
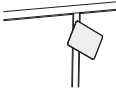
Prices in EURO

# QUADRO Accessories

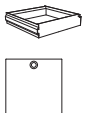
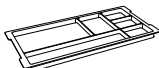
**Price**

	<p><b>Flexlock* (Private Mode)</b> (compatible with Mifare**)</p> <p>5140 Flexlock incl. mounted battery (available as accessories for Ecolabel products) 195</p> <p>5142 User card for Flexlock, 1 pcs. 12</p> <p>5143 Flexlock service card, 1 pcs. 27</p> <p>5144 Flexlock programming card, 1 pcs. 27</p> <p>5148 Flexlock Any User card (Public Mode), 1 pcs. 46</p> <p>5149 Flexlock battery (extra), 1 pcs. 9</p>	
	<p><b>Cube Mifare lock*</b> (Mifare Classic EV1 - EM4102 / Mifare Classic), remember handle or push</p> <p><b>5112 Cube Mifare lock incl. 1 battery, 1 user card, 1 user fob</b> 130</p> <p>5113 Cube Mifare user card, 1 pcs. 24</p> <p>5114 Cube Mifare manager card, 1 pcs. 24</p> <p>5115 Cube Mifare user fob, 1 pcs. 24</p>	
	<p><b>Letter trays in wood</b></p> <p>5517 Insert with 6 trays 450</p> <p>Made in ash, beech, maple, oak, walnut and in black, anthracite, charcoal grey, medium grey, light grey or white lacquer or lacquer in Nordic Nature.</p>	
	<p><b>Drawer insert with 4 drawers</b></p> <p>5104 Insert with 4 drawers for a pull-out cabinet 400</p> <p>Incl. milled handles</p>	
	<p><b>Drawer insert with 3 drawers</b></p> <p>5102 Insert with 3 drawers for a pull-out cabinet 322</p> <p>Incl. milled handles</p>	
	<p><b>Drawer insert with 2 drawers</b></p> <p>5103 Insert with 2 drawers for a pull-out cabinet 274</p> <p>Incl. milled handles</p>	
	<p><b>Suspension file</b></p> <p>5106 Suspension file <u>without</u> front 153</p> <p>5105 Suspension file <u>with</u> front 183</p>	
	<p><b>Milled pen tray</b></p> <p>5180 Milled pen tray in the top of the inner cabinet 62</p> <p>(Only for 5201, 5202, 5203, 5204, 5207, 5208, 5209, 5198, 5199)</p>	
	<p><b>Drawer insert A4 - Steel</b></p> <p>5186 Drawer insert with 6 drawers in powder coated alu steel 316</p> <p>H 365 mm x W 376 mm x D 240 mm - can be retrofitted</p>	
	<p><b>Drawer insert A4 - Plastic</b></p> <p>5187 Drawer insert with 6 drawers in black plastic 164</p> <p>H 365 mm x W 376 mm x D 240 mm - can be retrofitted</p>	

Veneer : ash, beech, maple or oak + 25% surcharge for walnut

\* To prolong battery life, we recommend doors are hinged on the same side when using electronic locks.

\*\* Mifare : 13,56 MHz : Mifare Classic 1k, Mifare Classic 4k, Mifare DESFire EV1 & EV2.

Prices in EURO

## QUADRO DRAWER UNIT



Cabinet available in :

- **Laminate** : Opaque White, Montana Grey, Platinum Grey, Anthracite Grey, Slate Grey, Volcanic Black, Lindberg Oak oder Congo
- **Veneer** : ash, beech, maple, oak or walnut\*

The bookcases are delivered with laminate or veneer on back panel and can be used as dividers.

Surface fronts :

- Standard laminate
- Nordic Nature (HPL)
- Veneer
- XP mat laminate\*
- Linoleum\*

\* Note surcharge see page 40.

### Quadro drawer unit in general :

- Drawer unit in 16 mm plates
- 7 cabinet colors in laminate
- 5 cabinet colors in veneer
- 3 heights
- 2 depths: D 430 and D 600 mm
- Suspension files with full pull-out
- Back panel in 8 mm plates
- 2 mm impact-resistant ABS edge (laminate cabinet)
- 2 mm wooden edge (veneer cabinet)
- 33 colors in laminate - of which 20 are high pressure laminate
- Nordic Nature fronts in high pressure laminate
- Central lock can be mounted
- 9 different handles - Standard Quadro handle in mat chrome, unless otherwise stated
- Delivered assembled - only handles and castors are to be mounted
- 2 lockable castors
- 10 years warranty





# QUADRO Drawer units

Laminate

Veneer

	<p><b>Drawer unit with 2 drawers</b></p> <p>5155    Drawer unit with 2 drawers Incl. pen tray and suspension file rack Fully extendable drawers</p> <p>We recommend 5529 counterweight by suspension file drawers. Room for 6 trays (5122) in the lower drawer (accessories).</p>	<p>392</p>	<p>468</p>
	<p><b>Drawer unit with 3 drawers</b></p> <p>5156    Drawer unit with 3 drawers Incl. pen tray and suspension file rack Fully extendable drawers</p> <p>Room for 4 trays (5122) in the lower drawer (accessories).</p>	<p>392</p>	<p>468</p>
	<p><b>Drawer unit with 3 drawers</b></p> <p>5157    Drawer unit with 3 drawers Incl. pen drawer, plastic partitions and suspension file rack Lower drawer for suspension files with full pull-out</p> <p>We recommend 5529 counterweight by suspension file drawers. Room for 13 trays (5121) in the lower drawer (accessories).</p>	<p>585</p>	<p>701</p>
	<p><b>Drawer unit with 4 drawers</b></p> <p>5158    Drawer unit with 4 drawers Incl. pen drawer and plastic partitions</p> <p>Room for 4 trays (5122) in the lower drawer (accessories).</p>	<p>581</p>	<p>697</p>
	<p><b>Drawer unit with 3 drawers</b></p> <p>5167    Drawer unit with 3 drawers Incl. pen tray, plastic partitions and suspension file rack Lower drawer for suspension files with full pull-out</p> <p>We recommend 5529 counterweight by suspension file drawers. Room for 13 trays (5121) in the lower drawer (accessories).</p>	<p>585</p>	<p>701</p>
	<p><b>Drawer unit with 4 drawers</b></p> <p>5168    Drawer unit with 4 drawers Incl. pen tray and plastic partitions</p> <p>Room for 4 trays (5122) in the lower drawer (accessories).</p>	<p>581</p>	<p>697</p>
<p><b>Surcharge</b></p> <p>5553    Fronts with linoleum or XP mat laminate</p> <p>3250    Fully extendable drawer, per drawer</p>		<p><b>Price</b></p>	<p>34</p> <p>24</p>

Prices in EURO

# QUADRO Accessories





**Price**
**Handles**

	<b>5450</b>
	<b>9531</b>
	<b>5451</b>
	<b>5456</b>
	<b>5465</b>

**Handles without surcharge** (Choose freely between these handles - all fronts are with handles)

5450	Quadro handle in white, black, polished chrome, brass or mat chrome (Standard handle in mat chrome, unless otherwise stated)	
9531	Mosaik handle, mat chrome	
5451	Knob handle in white, black, brass, mat chrome or polished chrome	
5456	Knob handle with grooves	
	Loose handles, 1 pcs.	8

**Surcharge**

	<b>5463</b>
	<b>5464</b>
	<b>5471</b>
	<b>5472</b>
	<b>5473</b>

**Handles with surcharge**

5463	Milled handle, Ø 50/40 mm in stainless steel, black or brass	18
5464	Milled handle, 143 mm x 34 mm in alu, white, black or brass	18
5471	Ribbed knob handle, Ø 30 mm, in solid brass. Color: black, stainless steel or brass	16
5472	Ribbed knob handle, Ø 16 mm, in solid brass. Color: black, stainless steel or brass	13
5473	Ribbed handle, 128 mm, in solid brass. Color: black, stainless steel or brass	27
	The price is a surcharge.	

**Plastic pen tray**

5508	Plastic pen tray, 1 pcs.	13
------	--------------------------	----

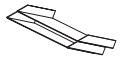
**Sloping document trays**

5122	Plastic trays, set of 2 pcs.	15
5121	Plastic trays for suspension file drawers, set of 13 pcs.	91
	5122 fits drawers higher than 130 mm.	

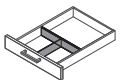
**Plastic partitions**

5125	Plastic partitions, per set	5
------	-----------------------------	---

**Locks**

5137	Lock for drawer unit (only upper drawer), per pcs.	43
5124	Central lock for pedestal, per pcs.	125
	Locks are mounted in the upper right side of the front.	

**Counterweight**

5529	Counterweight (approx. 6,5 kg)	81
------	--------------------------------	----



# QUADRO LOCKERS

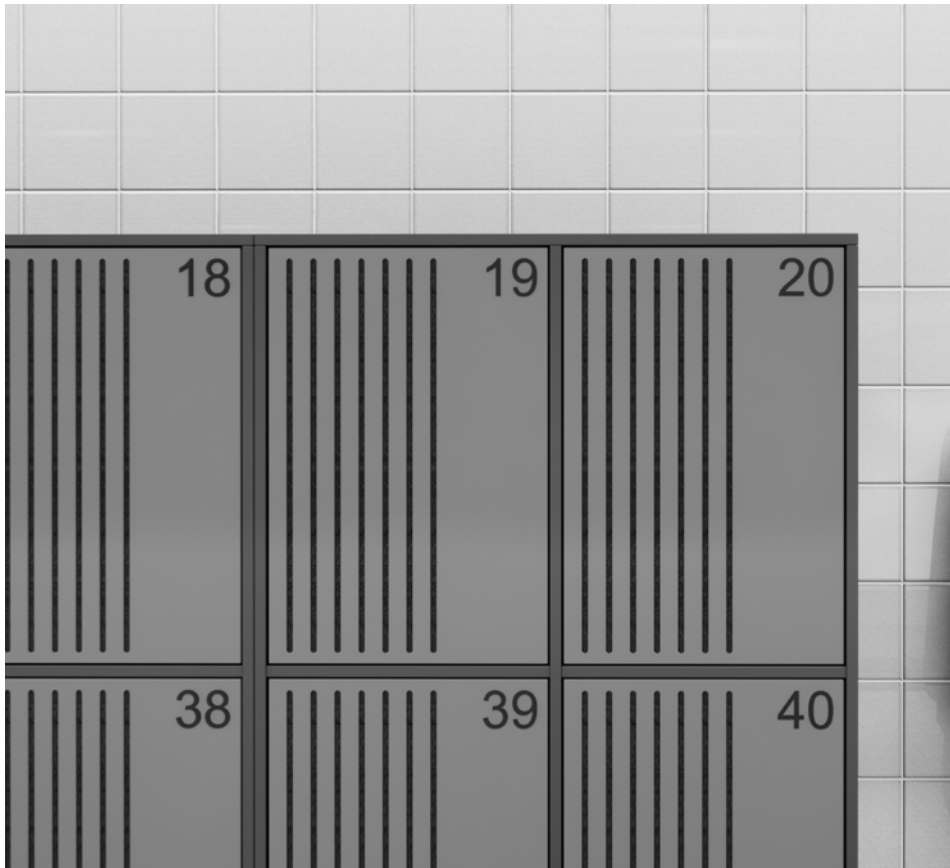

### Quadro lockers in general:

- Made in 16 mm plates
- 7 cabinet colors in laminate
- 5 cabinet colors in veneer
- 2 depths: D 430 mm and D 550 mm
- Back panel in 8 mm plates
- 2 mm impact-resistant ABS edge (laminate cabinet)
- 2 mm wooden edge (veneer cabinet)
- 33 colors in laminate - of which 20 are high pressure laminate
- Nordic Nature fronts in high pressure laminate
- 9 different handles - Standard knob handle in mat chrome, unless otherwise stated
- Delivered assembled - only handles, legs and castors are to be mounted
- EN16121+EN16122 tested
- 10 years warranty

Cabinet available in :

- **Laminate** : Opaque White, Montana Grey, Platinum Grey, Anthracite Grey, Slate Grey, Volcanic Black, Lindberg Oak or Congo
- **Veneer** : ash, beech, maple, oak or walnut\*

The bookcases are delivered with laminate or veneer on back panel and can be used as dividers.

Surface - fronts :

- Standard laminate
- Nordic Nature (HPL)
- Veneer
- XP mat laminate\*
- Linoleum\*

Support :

- Plinth
- Plate plinth
- Leg plinth
- Wall bracket
- Castors
- Legs

\* Note surcharge see page 48.

We recommend that lockers over 3 rooms high are fixed to the wall or floor.

A5	B5	C5
A4	B4	C4
A3	B3	C3
A2	B2	C2
A1	B1	C1

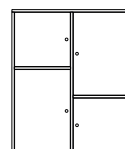
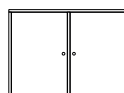

# QUADRO Lockers

**EU Ecolabel  
product in  
laminate**
**Laminate**
**Veneer**

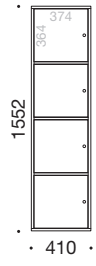
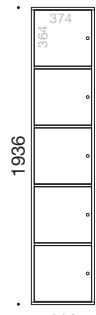
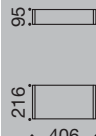
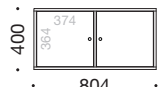
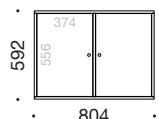
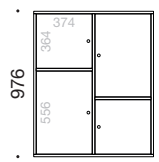
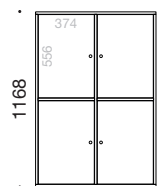
	<p><b>Locker</b></p> <p>5037<b>ECO</b> Locker, D 430 mm</p> <p>5038<b>ECO</b> Locker, D 550 mm</p>	<p>685</p> <p>840</p>	<p>685</p> <p>840</p>	<p>815</p> <p>964</p>
	<p><b>Locker</b></p> <p>5039<b>ECO</b> Locker, D 430 mm</p> <p>5040<b>ECO</b> Locker, D 550 mm</p>	<p>794</p> <p>950</p>	<p>794</p> <p>950</p>	<p>946</p> <p>1.094</p>
	<p><b>Plinths (1-room wide)</b></p> <p>5402<b>ECO</b> Low plinth for D 430 (H95xW406xD390mm)</p> <p>3185<b>ECO</b> Low plinth for D 550 (H95xW406xD510mm)</p> <p>5403<b>ECO</b> High plinth for D 430 (H216xW406xD390mm)</p> <p>3186<b>ECO</b> High plinth for D 550 (H216xW406xD510mm)</p>	<p>66</p> <p>69</p> <p>111</p> <p>116</p>	<p>66</p> <p>69</p> <p>111</p> <p>116</p>	<p>79</p> <p>90</p> <p>133</p> <p>139</p>
	<p><b>Locker</b></p> <p>5011<b>ECO</b> Locker, D 430 mm</p> <p>5012<b>ECO</b> Locker, D 550 mm</p>	<p>381</p> <p>477</p>	<p>381</p> <p>477</p>	<p>453</p> <p>575</p>
	<p><b>Locker</b></p> <p>5013<b>ECO</b> Locker, D 430 mm</p> <p>5014<b>ECO</b> Locker, D 550 mm</p>	<p>439</p> <p>549</p>	<p>439</p> <p>549</p>	<p>530</p> <p>662</p>
	<p><b>Locker</b></p> <p>5015<b>ECO</b> Locker, D 430 mm</p> <p>5016<b>ECO</b> Locker, D 550 mm</p>	<p>810</p> <p>1.012</p>	<p>810</p> <p>1.012</p>	<p>951</p> <p>1.189</p>
	<p><b>Locker</b></p> <p>5019<b>ECO</b> Locker, D 430 mm</p> <p>5020<b>ECO</b> Locker, D 550 mm</p>	<p>872</p> <p>1.088</p>	<p>872</p> <p>1.088</p>	<p>1.019</p> <p>1.272</p>

Prices in EURO

 Laminate : Opaque White, Montana Grey, Platinum Grey, Anthracite Grey, Slate Grey, Volcanic Black or Lindberg Oak.  
 Veneer : ash, beech, maple or oak + 25% surcharge for walnut

# QUADRO Lockers

**EU Ecolabel  
product in  
laminate**
**Laminate**
**Veneer**

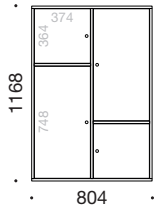
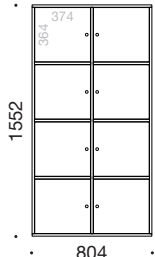
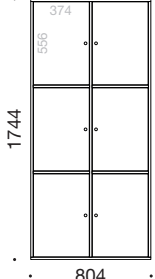
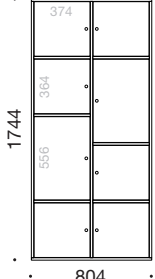
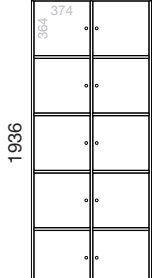
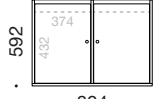
 <p>Diagram showing locker dimensions: height 1168 mm, width 804 mm. Internal compartments are 374 mm wide and 364 mm high. The bottom section is 748 mm high.</p>	<p><b>Locker</b></p> <p>5021<b>ECO</b> Locker, D 430 mm      872      872      1.019</p> <p>5022<b>ECO</b> Locker, D 550 mm      1.088      1.088      1.272</p>
 <p>Diagram showing locker dimensions: height 1552 mm, width 804 mm. Internal compartments are 374 mm wide and 364 mm high.</p>	<p><b>Locker</b></p> <p>5025<b>ECO</b> Locker, D 430 mm      1.169      1.169      1.517</p> <p>5026<b>ECO</b> Locker, D 550 mm      1.702      1.702      1.959</p>
 <p>Diagram showing locker dimensions: height 1744 mm, width 804 mm. Internal compartments are 374 mm wide and 556 mm high.</p>	<p><b>Locker</b></p> <p>5027<b>ECO</b> Locker, D 430 mm      1.429      1.429      1.660</p> <p>5028<b>ECO</b> Locker, D 550 mm      1.846      1.846      2.102</p>
 <p>Diagram showing locker dimensions: height 1744 mm, width 804 mm. Internal compartments are 374 mm wide and 566 mm high.</p>	<p><b>Locker</b></p> <p>5023<b>ECO</b> Locker, D 430 mm      1.441      1.441      1.729</p> <p>5024<b>ECO</b> Locker, D 550 mm      1.915      1.915      2.121</p>
 <p>Diagram showing locker dimensions: height 1936 mm, width 804 mm. Internal compartments are 374 mm wide and 564 mm high.</p>	<p><b>Locker</b></p> <p>5029<b>ECO</b> Locker, D 430 mm      1.444      1.444      1.802</p> <p>5030<b>ECO</b> Locker, D 550 mm      1.899      1.899      2.257</p>
 <p>Diagram showing locker dimensions: height 592 mm, width 804 mm. Internal compartments are 374 mm wide and 432 mm high.</p>	<p><b>Locker with letter slot</b></p> <p>5031<b>ECO</b> Locker with letter slot, D 430 mm      538      538      648</p> <p>5032<b>ECO</b> Locker with letter slot, D 550 mm      671      671      689</p>

Prices in EURO

 Laminate : Opaque White, Montana Grey, Platinum Grey, Anthracite Grey, Slate Grey, Volcanic Black or Lindberg Oak.  
 Veneer : ash, beech, maple or oak + 25% surcharge for walnut

# QUADRO Lockers

EU Ecolabel  
product in  
laminate

Laminate

Veneer

	<p><b>Locker with letter slot</b></p> <p>5033ECO Locker with letter slot, D 430 mm 1.067 1.067 1.245</p> <p>5034ECO Locker with letter slot, D 550 mm 1.331 1.331 1.555</p>
	<p><b>Locker with letter slot</b></p> <p>5035ECO Locker with letter slot, D 430 mm 1.723 1.723 1.946</p> <p>5036ECO Locker with letter slot, D 550 mm 2.155 2.155 2.431</p>
	<p><b>Plinths, 2-room wide</b></p> <p>5412ECO Low plinth for D 430 (H95xW800xD390mm) 76 76 90</p> <p>3181ECO Low plinth for D 550 (H95xW800xD510mm) 104 104 122</p> <p>5413ECO High plinth for D 430 (H216xW800xD390mm) 122 122 146</p> <p>3182ECO High plinth for D 550 (H216xW800xD510mm) 149 149 186</p>
	<p><b>Locker</b></p> <p>5041ECO Locker, D 430 mm 648 648 745</p> <p>5042ECO Locker, D 550 mm 810 810 931</p>
	<p><b>Locker</b></p> <p>5045ECO Locker, D 430 mm 1.281 1.281 1.460</p> <p>5046ECO Locker, D 550 mm 1.600 1.600 1.822</p>
	<p><b>Plinths, 3-room wide</b></p> <p>5435ECO Low plinth for D 430 (H95xW1194xD390mm) 93 93 113</p> <p>3183ECO Low plinth for D 550 (H95xW1194xD510mm) 123 123 144</p> <p>5437ECO High plinth for D 430 (H216xW1194xD390mm) 137 137 165</p> <p>3184ECO High plinth for D 550 (H216xW1194xD510mm) 164 164 200</p>
	<p><b>Adjustable plate plinth, H 22 mm</b></p> <p>5397ECO 2-room wide in D 430 mm (L 804 mm x D 430 mm) 43 43 48</p> <p>3191ECO 2-room wide in D 550 mm (L 804 mm x D 550 mm) 43 43 48</p> <p>5399ECO 3-room wide in D 430 mm (L 1198 mm x D 430 mm) 43 43 48</p> <p>3192ECO 3-room wide in D 550 mm (L 1198 mm x D 550 mm) 53 53 57</p>

Prices in EURO

Laminate : Opaque White, Montana Grey, Platinum Grey, Anthracite Grey, Slate Grey, Volcanic Black or Lindberg Oak.  
Veneer : ash, beech, maple or oak + 25% surcharge for walnut



# QUADRO Lockers

**Price**

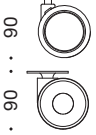
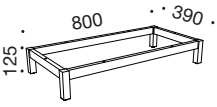
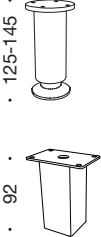
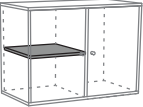
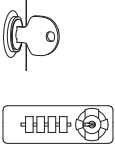
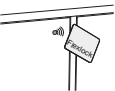
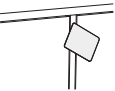
	<p><b>Wall bracket</b></p> <p>5525 Wall bracket (only for 1-room high cabinets) 57</p> <p>5530 Wall bracket with extra support 103</p> <p>5522 Double wall bracket (for large lockers, see item no. below) 113</p>
 <p>5527</p> <p>5521</p> <p>5572</p>	<p><b>Castor</b></p> <p>5527 Standard castor (grey), 1 pcs. 19</p> <p>5521 Castor with cover plate in Nordic Nature, 1 pcs. 35</p> <p>5572 Castor with cover plate in white or black, 1 pcs. 22</p> <p>We recommend using 5 castors for W 1198 mm and D 550 mm.</p>
	<p><b>Leg plinth in black metal with adjustable shoes, D 430 mm</b></p> <p>5481 Leg plinth, H 125 mm x W 800 mm x D 390 mm 150</p> <p>5482 Leg plinth, H 125 mm x W 1194 mm x D 390 mm 165</p>
 <p>125-145</p> <p>92</p>	<p><b>Round legs</b></p> <p>5420 Alu-leg with height adjustment 125-145 mm, 1 pcs. 41</p> <p>5419 Alu-leg with height adjustment 180-200 mm, 1 pcs. 60</p> <p><b>Square legs</b></p> <p>5418 Square legs in steel with adjustable foot, 1 pcs. 19</p> <p>We recommend using 5 legs for W 1198 mm and D 550 mm.</p>
	<p><b>Extra shelf</b></p> <p>5546 Shelf for D 430 mm, 378 x 388 mm 40 48</p> <p>5544 Shelf for D 550 mm, 378 x 508 mm 47 55</p>
 <p>5120</p> <p>5136</p>	<p><b>Locks</b></p> <p>5119 Lock, right door 41</p> <p>5120 Lock, left door, drawers and pull out cabinets 41</p> <p>5132 Combination lock public mode (black), right door - can not be retrofitted 48</p> <p>5136 Combination lock public mode (black), left door - can not be retrofitted 48</p> <p>5146 Combination lock (black), right door - can not be retrofitted 48</p> <p>5147 Combination lock (black), left door - can not be retrofitted 48</p> <p>5133 Bracket for padlock 41</p> <p>5128 Master Key 25</p>
	<p><b>Flexlock* (Private Mode) (compatible with Mifare**)</b></p> <p>5140 Flexlock incl. mounted battery (available as accessories for Ecolabel products). 195</p> <p>5142 User card for Flexlock, 1 pcs. 12</p> <p>5143 Flexlock service card, 1 pcs. 27</p> <p>5144 Flexlock programming card, 1 pcs. 27</p> <p>5148 Flexlock Any User card (Public Mode), 1 pcs. 46</p> <p>5149 Flexlock battery (extra), 1 pcs. 9</p>
	<p><b>Cube Mifare lock** (Mifare Classic EV1 - EM4102 / Mifare Classic), remember handle or push</b></p> <p>5112 Cube Mifare lock incl. 1 battery, 1 user card, 1 user fob 130</p> <p>5113 Cube Mifare user card, 1 pcs. 24</p> <p>5114 Cube Mifare manager card, 1 pcs. 24</p> <p>5115 Cube Mifare user fob, 1 pcs. 24</p>

5522 is used for : 5025, 5026, 5027, 5028, 5035, 5036, 5045, 5046, 5023.

\* To prolong battery life, we recommend doors are hinged on the same side when using electronic locks.

\*\* Mifare : 13,56 MHz : Mifare Classic 1k, Mifare Classic 4k, Mifare DESFire EV1 & EV2.

Prices in EURO

# QUADRO Lockers

Price

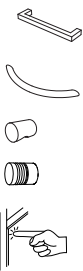
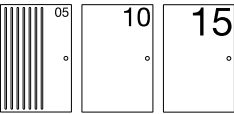
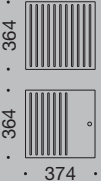
 <p>5450 9531 5451 5456 5465</p>	<p><b>Handles <u>without</u> surcharge</b> (Choose freely between these handles - all fronts are with handles)</p> <p>5450 Quadro handle in white, black, polished chrome, brass or mat chrome*</p> <p>9531 Mosaik handle, mat chrome</p> <p>5451 Knob handle in white, brass, black, mat chrome or polished chrome (Standard handle in mat chrome, unless otherwise stated)</p> <p>5456 Knob handle with grooves</p> <p>5465 Push bracket for door (Not for storage with castors)</p> <p>*Available as accessories for Ecolabel products. Choose between white, black, or mat chrome.</p>																								
	<p><b>Number on door (white or black)</b></p> <p>5005 Small number on door, H 50 mm, per door for max. 2 digits 15</p> <p>5006 Medium number on door, H 100 mm, per door for max. 2 digits 19</p> <p>5007 Large number on door, H 155 mm, per door for max. 2 digits 24</p> <p>The number is placed at the top of the door.</p>																								
	<p><b>Surcharge</b></p> <p>5553 Fronts with linoleum or XP laminate, per 1-3 room high door / drawer insert 34</p> <p>5575 Fronts with linoleum or XP laminate, per 4-5 room high door 67</p>																								
 <p>11 slats 7 slats</p>	<table border="1"> <thead> <tr> <th></th> <th></th> <th>Laminate/Veneer</th> <th>XP laminate</th> </tr> </thead> <tbody> <tr> <td colspan="4"><b>Surcharge</b></td> </tr> <tr> <td>7950</td> <td>Door with 11 slats, per 1 room high door</td> <td>58</td> <td>58</td> </tr> <tr> <td>7951</td> <td>Door with 11 slats, per 2 room high door</td> <td>69</td> <td>69</td> </tr> <tr> <td>7952</td> <td>Door with 7 slats, per 1 room high door</td> <td>58</td> <td>58</td> </tr> <tr> <td>7953</td> <td>Doort with 7 slats, per 2 room high door</td> <td>69</td> <td>69</td> </tr> </tbody> </table> <p>Doors with slats are made in black or brown MDF. Please inform which color.</p>			Laminate/Veneer	XP laminate	<b>Surcharge</b>				7950	Door with 11 slats, per 1 room high door	58	58	7951	Door with 11 slats, per 2 room high door	69	69	7952	Door with 7 slats, per 1 room high door	58	58	7953	Doort with 7 slats, per 2 room high door	69	69
		Laminate/Veneer	XP laminate																						
<b>Surcharge</b>																									
7950	Door with 11 slats, per 1 room high door	58	58																						
7951	Door with 11 slats, per 2 room high door	69	69																						
7952	Door with 7 slats, per 1 room high door	58	58																						
7953	Doort with 7 slats, per 2 room high door	69	69																						

## QUADRO MIX



Cabinet available in :

- **Laminate** : Opaque White, Montana Grey, Platinum Grey, Anthracite Grey, Slate Grey, Volcanic Black, Lindberg Oak or Congo
- **Veneer** : ash, beech, maple, oak or walnut\*

The bookcases are delivered with laminate or veneer on back panel.

Surface - fronts :

- Standard laminate
- Nordic Nature (HPL)
- Veneer
- XP mat laminate\*
- Linoleum\*

\* Note surcharge see page 52.

\*\* We do not recommend table top in Veneer.

### Wardrobes in general:

- Made in 16 mm plates
- Back panel in 8 mm plates
- 2 mm impact-resistant ABS edge (laminate cabinet)
- 2 mm wooden edge (veneer cabinet)
- 33 colors in laminate - of which 20 are high pressure laminate
- Nordic Nature fronts in high pressure laminate
- 9 different handles
- Delivered assembled - only handles, and legs are to be mounted
- 10 years warranty
- We recommend that wardrobes are fixed to the wall or floor

### Coffee station in general:



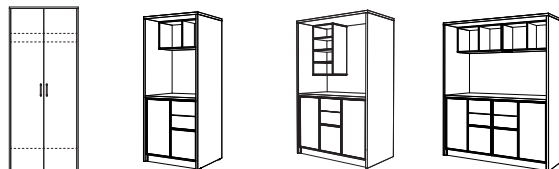

- Made in 30 mm plates with HPL or Veneer\*\*
- Back panel in 16 mm plates
- 2 mm impact-resistant ABS edge (laminate cabinet)
- 2 mm wooden edge (veneer cabinet)
- 33 colors in laminate on fronts - of which 20 are high pressure laminate
- Delivered unassembled - storage are delivered assembled
- 10 years warranty

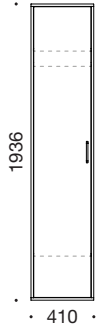
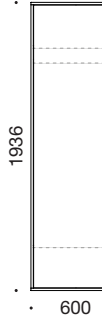
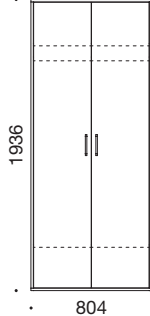

**QUADRO** Wardrobe

Laminate

Veneer

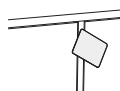
	<p><b>Wardrobe, D 600 mm</b></p> <p>5957 Wardrobe with clothes rack, hat- and shoe shelf</p> <p>5402G Plinth, H 95 x W 406 x D 560 mm</p> <p>5588 Shelf for 5957 (extra), W 378 mm x D 558 mm</p>	<p>619</p> <p>74</p> <p>47</p>	<p>714</p> <p>94</p> <p>55</p>
	<p><b>Wardrobe, D 600 mm</b></p> <p>5960 Wardrobe with clothes rack, hat- and shoe shelf</p> <p>5411G Plinth, H 95 x W 596 x D 560 mm</p> <p>5590 Shelf for 5960 (extra), W 568 mm x D 558 mm</p>	<p>951</p> <p>81</p> <p>62</p>	<p>1.066</p> <p>96</p> <p>70</p>
	<p><b>Wardrobe, D 430 mm</b></p> <p>5958 Wardrobe with pull out clothes rack, hat- and shoe shelf</p> <p>5412 Plinth, H 95 x W 800 x H 390 mm</p> <p>5551 Shelf for 5958 (extra), W 772 mm x D 388 mm</p> <p><b>Wardrobe, D 600 mm</b></p> <p>5959 Wardrobe with clothes rack, hat- and shoe shelf</p> <p>5412G Plinth, H 95 x W 800 x D 560 mm</p> <p>5594 Shelf for 5959 (extra), W 772 mm x D 558 mm</p>	<p>1.205</p> <p>76</p> <p>107</p> <p>1.322</p> <p>93</p> <p>107</p>	<p>1.359</p> <p>90</p> <p>128</p> <p>1.471</p> <p>113</p> <p>128</p>
 <p><b>5120</b></p>  <p><b>5139</b></p>  <p><b>5136</b></p>  <p><b>5140</b></p>  <p><b>5112</b></p>	<p><b>Locks</b></p> <p>5119 Lock, right door</p> <p>5120 Lock, left door, drawers and pull out cabinets</p> <p>5139 Lock for cabinet without divider (mounted in the right door)</p> <p>5132 Combination lock public mode (black), right door - can not be retrofitted</p> <p>5136 Combination lock public mode (black), left door - can not be retrofitted</p> <p>5146 Combination lock (black), right door - can not be retrofitted</p> <p>5147 Combination lock (black), left door - can not be retrofitted</p> <p>5140 Flexlock* incl. mounted battery (compatible with Mifare**)</p> <p>5142 User card for Flexlock, 1 pcs.</p> <p>5143 Flexlock service card, 1 pcs.</p> <p>5144 Flexlock programming card, 1 pcs.</p> <p>5148 Flexlock Any User card (Public Mode), 1 pcs.</p> <p>5149 Flexlock battery (extra), 1 pcs.</p> <p>5112 Cube Mifare lock incl. 1 battery, 1 user card, 1 user fob</p> <p>5113 Cube Mifare user card, 1 pcs.</p> <p>5114 Cube Mifare manager card, 1 pcs.</p> <p>5115 Cube Mifare user fob, 1 pcs.</p>	<p><b>Price</b></p> <p>41</p> <p>41</p> <p>53</p> <p>48</p> <p>48</p> <p>48</p> <p>48</p> <p>195</p> <p>12</p> <p>27</p> <p>27</p> <p>46</p> <p>9</p> <p>130</p> <p>24</p> <p>24</p> <p>24</p>	

Veneer : ash, beech, maple or oak + 25% surcharge for walnut.

\* To prolong battery life, we recommend doors are hinged on the same side when using electronic locks.

\*\* Mifare : 13,56 MHz : Mifare Classic 1k, Mifare Classic 4k, Mifare DESFire EV1 & EV2.

Prices in EURO

# QUADRO Coffee station

Laminate

Veneer

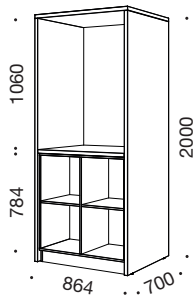

### Coffee station, 2 rooms

Total price 3.454 4.303

Coffee station contains:

- 4151 Coffee station bridge with backing
- 5351 Quadro bookcase, H 784 x W 804 x D 430 mm
- 5412 Low plinth for D 430 mm (H 95 x W 800 x D 390 mm)

The Coffee station can be furnished with standard Quadro storage. See page 14-27.

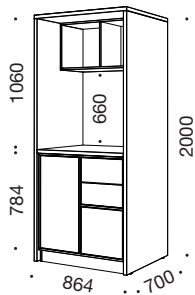

### Price example: Coffee station with Quadro storage, 2 rooms

Total price 4.386 5.306

Coffee station contains:

- 4151 Coffee station bridge with backing
- 5351 Quadro bookcase, H 784 x W 804 x D 430 mm
- 5412 Low plinth for D 430 mm (H 95 x W 800 x D 390 mm)
- 5581 Quadro door, 2-room high, left hinged incl. push bracket (5465)
- 5232 Insert with 1 drawer, D 430 mm
- 5513 Insert with 2 drawers, D 430 mm
- 5466 3 x push bracket for drawers
- 5313 Quadro bookcase, H 400 x W 804 x D 350 mm
- 5470 Wall bracket for bookcase in the coffee station

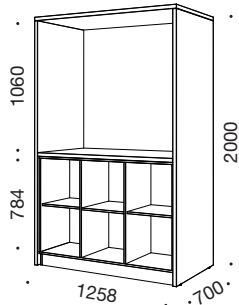

### Coffee station, 3 rooms

Total price 3.671 4.575

Coffee station contains:

- 4150 Coffee station bridge with backing
- 5371 Quadro bookcase, H 784 x W 1198 x D 430 mm
- 5435 Low plinth for D 430 mm (H 95 x W 1194 x D 390 mm)

The Coffee station can be furnished with standard Quadro storage. See page 14-27.

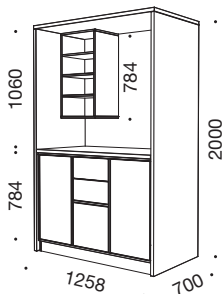

### Price example: Coffee station with Quadro storage, 3 rooms

Total price 4.771 5.796

Coffee station contains:

- 4150 Coffee station bridge with backing
- 5371 Quadro bookcase, H 784 x W 1198 x D 430 mm
- 5435 Low plinth for D 430 mm (H 95 x W 1194 x D 390 mm)
- 5581 Quadro door, 2-room high, left hinged incl. push bracket (5465)
- 5581 Quadro door, 2-room high, right hinged incl. push bracket (5465)
- 5232 Insert with 1 drawer, D 430 mm
- 5513 Insert with 2 drawers, D 430 mm
- 5466 3 x push bracket for drawers
- 5302 Quadro bookcase, H 784 x W 410 x D 350 mm
- 5540 2 x shelf for a bookcase
- 5470 Wall bracket for bookcase in the Coffee station

# QUADRO Coffee station

Laminate

Veneer

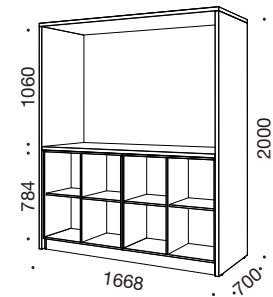

**Coffee station, 4 rooms**

Total price 4.181 5.405

Coffee station contains :

- 4152 Coffee station bridge with backing
- 5351 2 x Quadro bookcase, H 784 x W 804 x D 430 mm
- 3156 Low plinth for D 430 mm (H 95 x W 1604 x D 390 mm)

The Coffee station can be furnished with standard Quadro storage. See page 14-27.

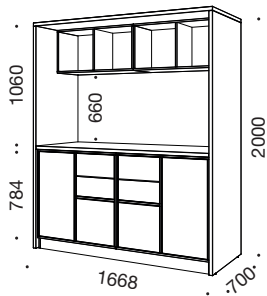

**Price example: Coffee station with Quadro storage, 4 rooms**

Total price 6.045 7.411

Coffee station contains :

- 4152 Coffee station bridge with backing
- 5351 2 x Quadro bookcase, H 784 x W 804 x D 430 mm
- 3156 Low plinth for D 430 mm (H 95 x W 1604 x D 390 mm)
- 5581 Quadro door, 2-room high, left hinged incl. push bracket (5465)
- 5581 Quadro door, 2-room high, right hinged incl. push bracket (5465)
- 5232 2 x Insert for 1 drawer, D 430 mm
- 5513 2 x Insert for 2 drawers, D 430 mm
- 5466 6 x push bracket for drawers
- 5313 2 x Quadro bookcase, H 400 x W 804 x D 350 mm
- 5470 2 x Wall bracket for bookcase in the Coffee station

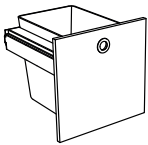

**Drawer with plastic container**

- 5089 Drawer incl. 20L plastic container 260 293
  - 7974 Trash bags for 20L plastic container, 100 pcs. 69
- E.g. used for waste, coffee grounds etc.

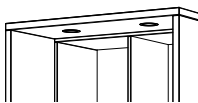

**LED spotlights**

7452 LED spotlights incl. a touch dimmer master switch to control the light, per set 286

Note, a set consist of 2 spots in a 2 room wide coffee station and 3 spots in a 3-4 room wide coffee station.



Ø60

**Cable grommets – more options. See page 79 and 122.**

**Surcharge**

- 5553 Fronts with linoleum or XP laminate, per 1-3 room high door / drawer insert 34
- 5575 Fronts with linoleum or XP laminate, per 4-5 room high door 67
- 3280 Table top with XP laminat 127
- 4161 Table top in Corian (Glacier White) or compact laminate, 2 room wide coffee station 699
- 4160 Table top in Corian (Glacier White) or compact laminate, 3 room wide coffee station 839
- 4162 Table top in Corian (Glacier White) or compact laminate, 4 room wide coffee station 979
- 4171 Backing with HPL, 2 room wide coffee station 215
- 4170 Backing with HPL, 3 room wide coffee station 267
- 4172 Backing with HPL, 4 room wide coffee station 320



# QUADRO DIVIDER



Frame\* available in :

- Black powder coat
- White powder coat

\* We recommend that the frames are fixed to the floor.

Accessories :

- Shelf
- Shelf with hanger bar
- Flower box
- Bookcase 1/2-3 room high
- Cabinet 1-3 room high
- Recycling station
- Locker 1-3 room high
- Sliding door cabinet

## Quadro Divider in general :

- Frame in black or white powder coat
- Height: 1900 mm incl adjustable shoes
- Made in 2 mm steel
- Shelf pinholes for flexible interior design with standard Quadro storage
- Accessories in W 804 mm and D 430 mm - maximum H 1168 mm
- Delivered unassembled - storage is delivered assembled
- Tool for mounting the storage included
- 10 years warranty

## NOTE

The Quadro Divider must consist of at least 1 room high module in the bottom and a shelf in the top and the frame must be fixed to the floor.

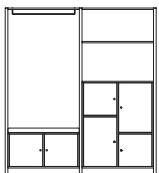

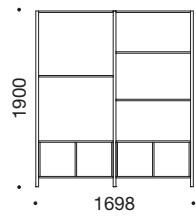

# QUADRO Divider

**Laminate**
**Veneer**

**Price example Quadro Divider, 2 sections**

Total price 1.758 1.956

This 2 section Quadro Divider contains :

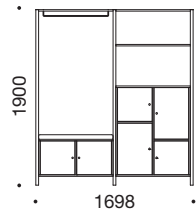
5611	3 x Frame, H 1900 x W 30 x D 347 mm	711	711
5615	5 x Shelf, H 16 mm	605	715
5332	2 x Bookcase, H 400 mm	442	530

**Price example Quadro Divider, 2 sections**

Total price 2.674 2.953

This 2 section Quadro Divider contains :

5611	3 x Frame, H 1900 x W 30 x D 347 mm	711	711
5618	1 x Shelf with hanger bar, H 76 mm	232	254
5615	2 x Shelf, H 16 mm	242	286
5333	1 x Cabinet, H 400 mm	381	453
3582	1 x Cushion, H 50 mm	298	298
5015	1 x Locker with 2 small and 2 large doors, H 976 mm	810	951

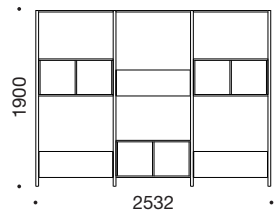
**Price example Quadro Divider, 3 sections**

Total price 2.838 3.219

This 3 section Quadro Divider contains :

5611	4 x Frame, H 1900 x W 30 x D 347 mm	948	948
5615	3 x Shelf, H 16 mm	363	429
5265	3 x Bookcase, no backing, H 400 mm	663	795
5221	3 x Flower box, H 280 mm	864	1.047

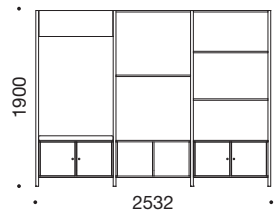
**Price example Quadro Divider, 3 sections**

Total price 3.122 3.481

This 3 section Quadro Divider contains :

5611	4 x Frame, H 1900 x W 30 x D 347 mm	948	948
5221	1 x Flower box, H 280 mm	288	349
5333	2 x Cabinet, H 400 mm	762	906
3582	1 x Cushion, H 50 mm	298	298
5615	5 x Shelf, H 16 mm	605	715
5265	1 x Bookcase, no backing, H 400 mm	221	265

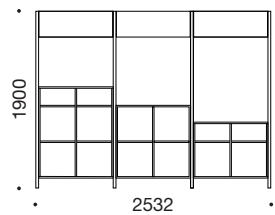
**Price example Quadro Divider, 3 sections**

Total price 2.930 3.349

This 3 section Quadro Divider contains :

5611	4 x Frame, H 1900 x W 30 x D 347 mm	948	948
5221	3 x Flower box, H 280 mm	864	1.047
5355	1 x Bookcase, H 984 mm	438	524
5351	1 x Bookcase, H 784 mm	340	415
5354	1 x Bookcase, H 600 mm	340	415

# QUADRO Divider

**Price**

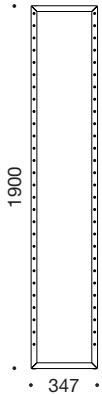
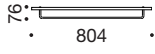
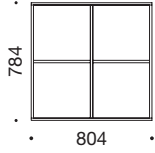
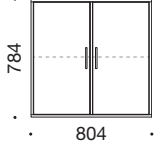
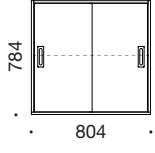
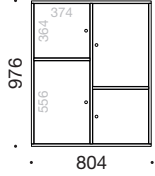
	<p><b>Frame for Quadro Divider</b></p> <p>5611 Frame, H 1900 x W 30 x D 347 mm, per. pcs <span style="float: right;">237</span></p> <p>Available in white or black.</p>																																	
	<table border="0" style="width: 100%;"> <thead> <tr> <th style="width: 60%;"></th> <th style="text-align: center;">Laminate</th> <th style="text-align: center;">Veneer</th> <th style="text-align: center;">Nordic Nature</th> </tr> </thead> <tbody> <tr> <td><b>Shelf for Quadro Divider, W 804 x D 430 mm</b></td> <td></td> <td></td> <td></td> </tr> <tr> <td>5615 Shelf, H 16 mm</td> <td style="text-align: center;">121</td> <td style="text-align: center;">143</td> <td style="text-align: center;">151</td> </tr> <tr> <td>5618 Shelf with hanger bar, H 76 mm</td> <td style="text-align: center;">232</td> <td style="text-align: center;">254</td> <td style="text-align: center;">263</td> </tr> </tbody> </table>		Laminate	Veneer	Nordic Nature	<b>Shelf for Quadro Divider, W 804 x D 430 mm</b>				5615 Shelf, H 16 mm	121	143	151	5618 Shelf with hanger bar, H 76 mm	232	254	263																	
	Laminate	Veneer	Nordic Nature																															
<b>Shelf for Quadro Divider, W 804 x D 430 mm</b>																																		
5615 Shelf, H 16 mm	121	143	151																															
5618 Shelf with hanger bar, H 76 mm	232	254	263																															
	<table border="0" style="width: 100%;"> <thead> <tr> <th style="width: 60%;"></th> <th style="text-align: center;">Laminate</th> <th style="text-align: center;">Veneer</th> </tr> </thead> <tbody> <tr> <td><b>Bookcase for Quadro Divider, W 804 x D 430 mm</b></td> <td></td> <td></td> </tr> <tr> <td>5427 Bookcase, H 216 mm</td> <td style="text-align: center;">221</td> <td style="text-align: center;">265</td> </tr> <tr> <td>5332 Bookcase, H 400 mm</td> <td style="text-align: center;">221</td> <td style="text-align: center;">265</td> </tr> <tr> <td>5265 Bookcase, no backing, H 400 mm</td> <td style="text-align: center;">221</td> <td style="text-align: center;">265</td> </tr> <tr> <td>5354 Bookcase, H 600 mm</td> <td style="text-align: center;">340</td> <td style="text-align: center;">415</td> </tr> <tr> <td>5320 Bookcase, no upper divider, H 784 mm</td> <td style="text-align: center;">340</td> <td style="text-align: center;">415</td> </tr> <tr> <td>5351 Bookcase, H 784 mm</td> <td style="text-align: center;">340</td> <td style="text-align: center;">415</td> </tr> <tr> <td>5355 Bookcase, H 984 mm</td> <td style="text-align: center;">438</td> <td style="text-align: center;">524</td> </tr> <tr> <td>5321 Bookcase, no upper divider, H 1168 mm</td> <td style="text-align: center;">438</td> <td style="text-align: center;">524</td> </tr> <tr> <td>5357 Bookcase, H 1168 mm</td> <td style="text-align: center;">438</td> <td style="text-align: center;">524</td> </tr> </tbody> </table>		Laminate	Veneer	<b>Bookcase for Quadro Divider, W 804 x D 430 mm</b>			5427 Bookcase, H 216 mm	221	265	5332 Bookcase, H 400 mm	221	265	5265 Bookcase, no backing, H 400 mm	221	265	5354 Bookcase, H 600 mm	340	415	5320 Bookcase, no upper divider, H 784 mm	340	415	5351 Bookcase, H 784 mm	340	415	5355 Bookcase, H 984 mm	438	524	5321 Bookcase, no upper divider, H 1168 mm	438	524	5357 Bookcase, H 1168 mm	438	524
	Laminate	Veneer																																
<b>Bookcase for Quadro Divider, W 804 x D 430 mm</b>																																		
5427 Bookcase, H 216 mm	221	265																																
5332 Bookcase, H 400 mm	221	265																																
5265 Bookcase, no backing, H 400 mm	221	265																																
5354 Bookcase, H 600 mm	340	415																																
5320 Bookcase, no upper divider, H 784 mm	340	415																																
5351 Bookcase, H 784 mm	340	415																																
5355 Bookcase, H 984 mm	438	524																																
5321 Bookcase, no upper divider, H 1168 mm	438	524																																
5357 Bookcase, H 1168 mm	438	524																																
	<p><b>Cabinet for Quadro Divider, W 804 x D 430 mm</b></p> <p>5333 Cabinet, H 400 mm <span style="float: right;">381 453</span></p> <p>5352 Cabinet, 1 shelf behind each door, H 784 mm <span style="float: right;">564 705</span></p> <p>5326 Cabinet, 1 shelf behind each door, H 1168 mm <span style="float: right;">662 814</span></p> <p>5358 Cabinet, 2 shelves behind each door, H 1168 mm <span style="float: right;">772 924</span></p>																																	
	<p><b>Sliding door cabinet, W 804 x D 430 mm</b></p> <p>5296 Sliding door cabinet, H 784 mm <span style="float: right;">605 715</span></p> <p>5294 Sliding door cabinet, upper rooms open, H 1168 mm <span style="float: right;">735 873</span></p> <p>5295 Sliding door cabinet, H 1168 mm <span style="float: right;">741 869</span></p>																																	
	<p><b>Locker for Quadro Divider, W 804 x D 430 mm</b></p> <p>5011 Locker with 2 doors, H 400 mm <span style="float: right;">381 453</span></p> <p>5013 Locker with 2 doors, H 592 mm <span style="float: right;">439 530</span></p> <p>5015 Locker with 2 small and 2 large doors, H 976 mm <span style="float: right;">810 951</span></p> <p>5019 Locker with 4 doors, H 1168 mm <span style="float: right;">872 1.019</span></p> <p>5021 Locker with 2 small and 2 large doors, H 1168 <span style="float: right;">872 1.019</span></p> <p>5031 Locker with 2 doors and letter slot, H 592 mm <span style="float: right;">538 648</span></p> <p>5033 Locker with 4 doors and letter slot, H 1168 mm <span style="float: right;">1.067 1.245</span></p>																																	

Prices in EURO

**QUADRO** Divider

Laminate

Veneer

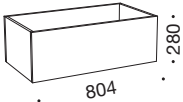
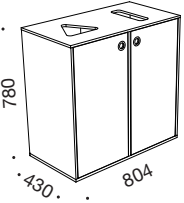
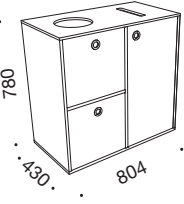
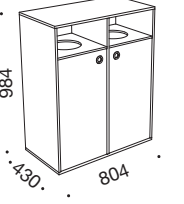
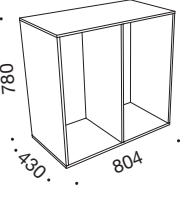
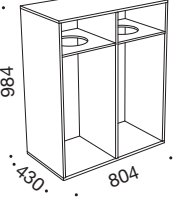
	<p><b>Flower box for Quadro Divider, W 804 x D 430 mm</b></p> <p>5221 Flower box, H 280 mm</p> <p>5072 Flower box with raised bottom, H 500 mm</p>	<p>288</p> <p>287</p>	<p>349</p> <p>333</p>
	<p><b>Recycling station, 2 sections</b></p> <p>5381 2 sections with</p> <p>A: Paper carving and room with bag pullout</p> <p>B: Triangle carving and room with bag pullout</p>	<p>895</p>	<p>1.036</p>
	<p><b>Recycling station, 2 sections</b></p> <p>4115 2 sections with</p> <p>A: Circle 210 carving and room with drawers incl. two plastic containers (20L) and a plastic insert for batteries (1,3L)</p> <p>B: Paper carving and room with bag pullout</p>	<p>1.141</p>	<p>1.317</p>
	<p><b>Recycling station, 2 sections with throw in</b></p> <p>4116 2 sections with</p> <p>A/B: throw in, Circle 210 carving and room with bag pullout</p>	<p>1.019</p>	<p>1.170</p>
	<p><b>Recycling station, 2 section cabinet</b></p> <p>5082 2 sections, empty cabinet</p> <p>Please inform which kind of carving and room you want in section A and B.</p> <p>See page 11 in the price list for carvings and room.</p>	<p>348</p>	<p>424</p>
	<p><b>Recycling station, 2 sections with throw in, cabinet</b></p> <p>5087 2 sections with throw in, empty cabinet</p> <p>Please inform which kind of carving and room you want.</p> <p>Note that you only can choose between 5093, 5091 and 5090 for this type of cabinet.</p> <p>See page 11 in the price list for carvings and room.</p>	<p>471</p>	<p>557</p>

## QUADRO FLOWER BOX



Cabinet available in :

- **Laminate** : Opaque White, Montana Grey, Platinum Grey, Anthracite Grey, Slate Grey, Volcanic Black, Lindberg Oak or Congo
- **Veneer** : ash, beech, maple, oak or walnut\*

Support :

- Plinth
- Plate plinth
- Castors
- Leg plinth
- Corner foot
- Round leg
- Square leg





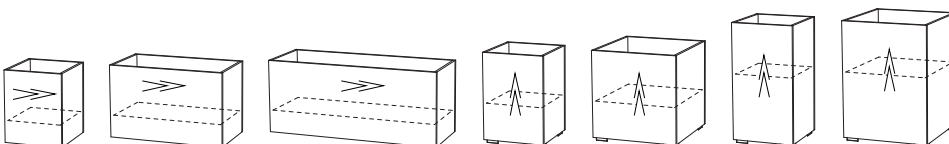

### Flower box in general :

- Made in 16 mm plates
- 7 cabinet colors in laminate
- 5 cabinet colors in veneer
- 2 mm impact-resistant ABS edge (laminate cabinet)
- 2 mm wooden edge (veneer cabinet)
- Without plastic liner
- Delivered assembled - only legs and castors are to be mounted
- 10 years warranty

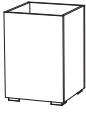
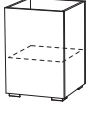
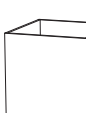
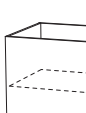
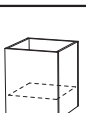

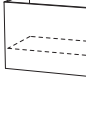
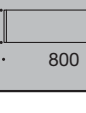
# QUADRO Flower box

**Laminate**
**Veneer**

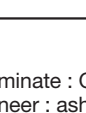
	<b>5050</b>	<b>Flower box <u>without</u> plastic liner for floor, W 430 mm</b>				
		5050	Flower box with corner feet H 625 x W 430 x D 430 mm	257	302	
		<b>5052</b>	<b>Flower box <u>without</u> plastic liner for floor, W 430 mm</b>			
			5052	Flower box with corner feet, raised bottom H 625 x W 430 x D 430 mm	257	302
	<b>5054</b>	<b>Flower box <u>without</u> plastic liner for floor, W 430 mm</b>				
		5054	Flower box with corner feet H 825 x W 430 x D 430 mm	287	333	
		<b>5056</b>	<b>Flower box <u>without</u> plastic liner for floor, W 430 mm</b>			
			5056	Flower box with corner feet, raised bottom H 825 x W 430 x D 430 mm	287	333
	<b>5060</b>	<b>Flower box <u>without</u> plastic liner for floor, W 600 mm</b>				
		5060	Flower box with corner feet H 625 x W 600 x D 600 mm	287	333	
		<b>5062</b>	<b>Flower box <u>without</u> plastic liner for floor, W 600 mm</b>			
			5062	Flower box with corner feet, raised bottom H 625 x W 600 x D 600 mm	287	333
	<b>5064</b>	<b>Flower box <u>without</u> plastic liner for floor, W 600 mm</b>				
		5064	Flower box with corner feet H 825 x W 600 x D 600 mm	317	363	
		<b>5066</b>	<b>Flower box <u>without</u> plastic liner for floor, W 600 mm</b>			
			5066	Flower box with corner feet, raised bottom H 825 x W 600 x D 600 mm	317	363
	<b>Flower box <u>without</u> plastic liner for floor, W 410 mm</b>					
	5071	Flower box with raised bottom H 500 x W 410 x D 430 mm	242	287		
	<b>Plinths (1-room wide)</b>					
	5402	Low plinth for D 430 mm (H 95 x W 406 x D 390 mm)	66	79		
	<b>Plinths (1-room wide)</b>					
	5403	High plinth for D 430 mm (H 216 x W 406 x D 390 mm)	111	133		
	<b>Flower box <u>without</u> plastic liner for floor, W 804 mm</b>					
	5072	Flower box with raised bottom H 500 x W 804 x D 430 mm	287	333		
	<b>Plinths, 2-room wide</b>					
	5412	Low plinth for D 430 mm (H 95 x W 800 x D 390 mm)	76	90		
	<b>Plinths, 2-room wide</b>					
	5413	High plinth for D 430 mm (H 216 x W 800 x D 390 mm)	122	146		
	<b>Flower box <u>without</u> plastic liner for floor, W 1198 mm</b>					
	5073	Flower box with raised bottom H 500 x W 1198 x D 430 mm	347	393		
	<b>Plinths, 3-room wide</b>					
	5435	Low plinth for D 430 mm (H 95 x W 1194 x D 390 mm)	93	113		
	<b>Plinths, 3-room wide</b>					
	5437	High plinth for D 430 mm (H 216 x W 1194 x D 390 mm)	137	165		
	<b>Adjustable plate plinth, H 22 mm</b>					
	5395	Plate plinth, H 22 x W 410 x D 430 mm	43	48		
	5397	Plate plinth, H 22 x W 804 x D 430 mm	43	48		
	5399	Plate plinth, H 22 x W 1198 x D 430 mm	43	48		

Prices in EURO

**QUADRO** Flower box

Price

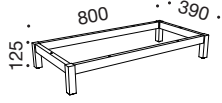
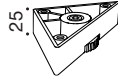
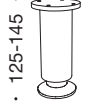
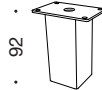
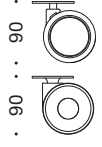
	<p><b>Leg plinth in black metal with adjustable shoes, D 430 mm</b></p> <p>5480 Leg plinth, H 125 x W 406 x D 390 mm 139</p> <p>5481 Leg plinth, H 125 x W 800 x D 390 mm 150</p> <p>5482 Leg plinth, H 125 x W 1194 x D 390 mm 165</p>
	<p><b>Corner foot</b></p> <p>5426 Adjustable plastic foot, 1 pcs. 8</p> <p>Adjust foot by using the enclosed umbraco key.</p>
	<p><b>Round legs</b></p> <p>5420 Alu-leg with height adjustment 125-145 mm, 1 pcs. 41</p> <p>5419 Alu-leg with height adjustment 180-200 mm, 1 pcs. 60</p>
	<p><b>Square legs</b></p> <p>5418 Square legs in steel with adjustable foot, 1 pcs. 19</p>
	<p><b>Castor</b></p> <p>5527 Standard castor (grey), 1 pcs. 19</p> <p>5521 Castor with cover plate in Nordic Nature, 1 pcs. 35</p> <p>5572 Castor with cover plate in white or black, 1 pcs. 22</p>





# V STORAGE



Cabinet available in :

- **Laminate** : Opaque White, Montana Grey, Platinum Grey, Anthracite Grey, Volcanic Black, Lindberg Oak or Congo
- **Veneer** : ash, beech, maple, oak or walnut\*

The bookcases are delivered with laminate or veneer on back panel and can be used as dividers.

Fronts :

- Doors
- Plexiglass doors
- Drawers / letter trays
- Suspension folders

Surface - fronts :

- Standard laminate
- Nordic Nature (HPL)
- Veneer
- XP mat laminate\*
- Linoleum\*

Support :

- Plinth
- Leg plinth (only for D 400 mm)
- Plate plinth
- Wall bracket
- Castors
- Legs
- Corner feet

\* Note surcharge see page 66.



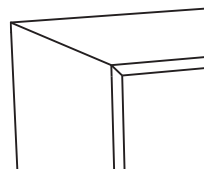

## V storage in general :

- Made in 16 mm plates
- 6 cabinet colors in laminate
- 5 cabinet colors in veneer
- 7 supports
- 3 widths on bookcases and cabinets
- 3 heights
- 2 depths: D 350 and D 400 mm
- Back panel in 8 mm plates
- Impact resistant ABS edges on mitre joints
- 2 mm impact-resistant ABS edge (laminate cabinet)
- 2 mm wooden edge (veneer cabinet)
- 33 colors in laminate - of which 20 are high pressure laminate
- Nordic Nature fronts in high pressure laminate
- 13 different handles
- Can be used as dividers
- Delivered assembled - only handles, legs and castors are to be mounted
- EN16121+EN16122 tested
- 10 years warranty

A3	B3	C3
A2	B2	C2
A1	B1	C1

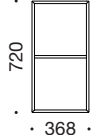
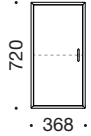
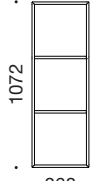
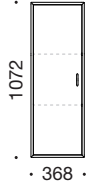

**V**
**Storage**
**Laminate**
**Veneer**

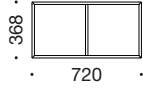
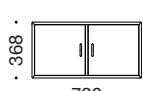
	<b>Bookcase</b> 6304 Bookcase, D 350 mm 6324 Bookcase, D 400 mm	126 151	151 180
	<b>Cabinet</b> 6305 Cabinet, D 350 mm 6322 Cabinet, D 400 mm The door is by default left hinged.	219 244	261 290
	<b>Bookcase</b> 6302 Bookcase, D 350 mm 6342 Bookcase, D 400 mm	235 272	282 328
	<b>Cabinet</b> 6303 Cabinet with 1 shelf behind the door, D 350 mm 6343 Cabinet with 1 shelf behind the door, D 400 mm The door is by default left hinged.	365 402	451 497
	<b>Bookcase</b> 6306 Bookcase, D 350 mm 6346 Bookcase, D 400 mm	321 347	404 435
	<b>Cabinet</b> 6307 Cabinet with 2 shelves behind the door, D 350 mm 6347 Cabinet with 2 shelves behind the door, D 400 mm The door is by default left hinged.	516 542	639 670
 	<b>Plinths (1-room wide)</b> 6401 Low plinth for D 350 mm (H 95 x W 363 x D 310 mm) 6402 Low plinth for D 400 mm (H 95 x W 363 x D 360 mm) 6404 High plinth for D 350 mm (H 216 x W 363 x D 310 mm) 6403 High plinth for D 400 mm (H 216 x W 363 x D 360 mm)	76 76 127 127	91 91 153 153
	<b>Bookcase</b> 6313 Bookcase, D 350 mm 6332 Bookcase, D 400 mm	235 274	282 328
	<b>Cabinet</b> 6314 Cabinet, D 350 mm 6333 Cabinet, D 400 mm	421 460	502 548

Prices in EURO

 Laminate : Opaque White, Montana Grey, Platinum Grey, Anthracite Grey, Volcanic Black or Lindberg Oak + corner list in Nordic Nature.  
 Veneer : ash, beech, maple or oak + 25% surcharge for walnut

**V**
**Storage**
**Laminate**
**Veneer**

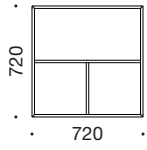
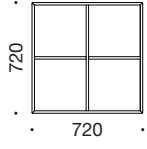
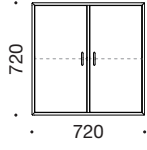
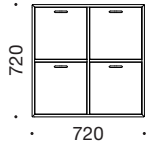
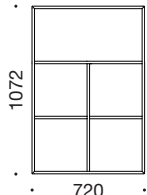
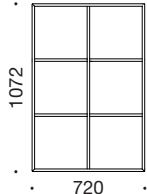
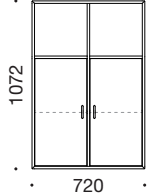
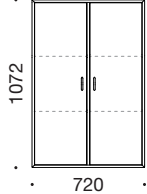

	<p><b>Bookcase</b></p> <p>6310 Bookcase, D 350 mm</p> <p>6320 Bookcase, D 400 mm</p> <p>Only 1-room high doors for this model.</p>	<p>382</p> <p>404</p>	<p>459</p> <p>484</p>
	<p><b>Bookcase</b></p> <p>6311 Bookcase, D 350 mm</p> <p>6351 Bookcase, D 400 mm</p>	<p>382</p> <p>404</p>	<p>459</p> <p>484</p>
	<p><b>Cabinet</b></p> <p>6312 Cabinet with 1 shelf behind each door, D 350 mm</p> <p>6352 Cabinet with 1 shelf behind each door, D 400 mm</p>	<p>642</p> <p>664</p>	<p>797</p> <p>822</p>
	<p><b>Cabinet with suspension file drawers, D 400 mm</b></p> <p>6353 Filing cabinet with 4 suspension file drawers and pull out barrier</p> <p>Central locking system is not an option for this model.</p>	<p>1.260</p>	<p>1.340</p>
	<p><b>Bookcase</b></p> <p>6327 Bookcase, D 350 mm</p> <p>6321 Bookcase, D 400 mm</p> <p>Only 1- and 2-room high doors for this model.</p> <p>Note, not supplied with wall mount.</p>	<p>522</p> <p>542</p>	<p>627</p> <p>652</p>
	<p><b>Bookcase</b></p> <p>6317 Bookcase, D 350 mm</p> <p>6357 Bookcase, D 400 mm</p>	<p>522</p> <p>542</p>	<p>627</p> <p>652</p>
	<p><b>Cabinet</b></p> <p>6319 Cabinet with 1 shelf behind each door, D 350 mm</p> <p>6326 Cabinet with 1 shelf behind each door, D 400 mm</p>	<p>782</p> <p>802</p>	<p>965</p> <p>990</p>
	<p><b>Cabinet</b></p> <p>6318 Cabinet with 2 shelves behind each door, D 350 mm</p> <p>6358 Cabinet with 2 shelves behind each door, D 400 mm</p>	<p>912</p> <p>932</p>	<p>1.097</p> <p>1.122</p>

Prices in EURO

Laminate : Opaque White, Montana Grey, Platinum Grey, Anthracite Grey, Volcanic Black or Lindberg Oak + corner list in Nordic Nature.

Veneer : ash, beech, maple or oak + 25% surcharge for walnut

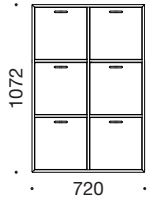
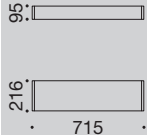
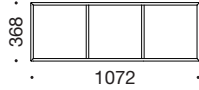
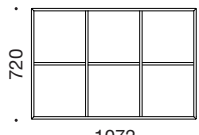
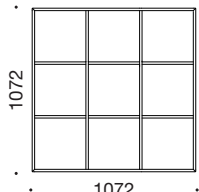
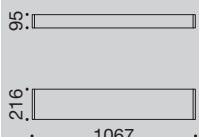
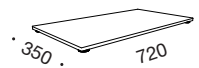
**V**
**Storage**
**Laminate**
**Veneer**



	<p><b>Cabinet with suspension file drawers, D 400 mm</b></p> <p>6359 Filing cabinet with 6 suspension file drawers and pull out barrier</p> <p>Central locking system is not an option for this model.</p>	<p>1.826</p>	<p>1.936</p>
	<p><b>Plinths (2-room wide)</b></p> <p>6411 Low plinth for D 350 mm (H 95 x W 715 x D 310 mm)</p> <p>6412 Low plinth for D 400 mm (H 95 x W 715 x D 360 mm)</p> <p>6414 High plinth for D 350 mm (H 216 x W 715 x D 310 mm)</p> <p>6413 High plinth for D 400 mm (H 216 x W 715 x D 360 mm)</p>	<p>88</p> <p>88</p> <p>140</p> <p>140</p>	<p>104</p> <p>104</p> <p>166</p> <p>166</p>
	<p><b>Bookcase</b></p> <p>6334 Bookcase, D 350 mm</p> <p>6335 Bookcase, D 400 mm</p>	<p>329</p> <p>342</p>	<p>412</p> <p>431</p>
	<p><b>Bookcase</b></p> <p>6336 Bookcase, D 350 mm</p> <p>6339 Bookcase, D 400 mm</p>	<p>561</p> <p>585</p>	<p>725</p> <p>750</p>
	<p><b>Bookcase</b></p> <p>6340 Bookcase, D 350 mm</p> <p>6341 Bookcase, D 400 mm</p>	<p>917</p> <p>993</p>	<p>1.149</p> <p>1.247</p>
	<p><b>Plinths (3-room wide)</b></p> <p>6415 Low plinth for D 350 mm (H 95 x W 1067 x D 310 mm)</p> <p>6417 Low plinth for D 400 mm (H 95 x W 1067 x D 360 mm)</p> <p>6416 High plinth for D 350 mm (H 216 x W 1067 x D 310 mm)</p> <p>6418 High plinth for D 400 mm (H 216 x W 1067 x D 360 mm)</p>	<p>108</p> <p>108</p> <p>157</p> <p>157</p>	<p>130</p> <p>130</p> <p>189</p> <p>189</p>
	<p><b>Adjustable plate plinth, H 22 mm</b></p> <p>6434 1-room wide in D 350 mm (L 368 mm x D 350 mm)</p> <p>6435 1-room wide in D 400 mm (L 368 mm x D 400 mm)</p> <p>6436 2-room wide in D 350 mm (L 720 mm x D 350 mm)</p> <p>6437 2-room wide in D 400 mm (L 720 mm x D 400 mm)</p> <p>6438 3-room wide in D 350 mm (L 1072 mm x D 350 mm)</p> <p>6439 3-room wide in D 400 mm (L 1072 mm x D 400 mm)</p>	<p>50</p> <p>50</p> <p>50</p> <p>50</p> <p>50</p> <p>50</p>	<p>55</p> <p>55</p> <p>55</p> <p>55</p> <p>55</p> <p>55</p>
	<p><b>Spacer for top plates</b></p> <p>5415 Alu-spacer - 100 mm, 1 pcs.</p>	<p></p>	<p>41</p>

Prices in EURO

 Laminate : Opaque White, Montana Grey, Platinum Grey, Anthracite Grey, Volcanic Black or Lindberg Oak + corner list in Nordic Nature.  
 Veneer : ash, beech, maple or oak + 25% surcharge for walnut

## V Accessory

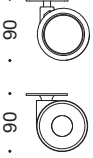
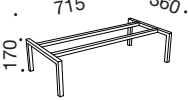
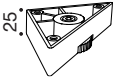
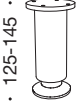
**Price**

	<p><b>Wall bracket</b></p> <p>5525 Wall bracket (only for 1-room high cabinets) 57</p> <p>5530 Wall bracket with extra support 103</p> <p>Please state the width of the cabinet when ordering.</p>
 <p>5527</p> <p>5521</p> <p>5572</p>	<p><b>Castor</b></p> <p>5527 Standard castor (grey), 1 pcs. 19</p> <p>5521 Castor with cover plate in Nordic Nature, 1 pcs. 35</p> <p>5572 Castor with cover plate in white or black, 1 pcs. 22</p> <p>We recommend using 5 castors for width 1072 mm - we do not recommend castors for depth 350 mm.</p>
 <p>715</p> <p>360</p> <p>170</p>	<p><b>Leg plinth in black metal, D 400 mm</b></p> <p>6483 Leg plinth with adjustable shoes, H 170 x W 715 x D 360 mm 229</p> <p>6481 Leg plinth with adjustable shoes, H 170 x W 363 x D 360 mm 229</p>
 <p>25</p>	<p><b>Corner foot</b></p> <p>5426 Adjustable plastic foot, 1 pcs. 8</p> <p>Adjust foot by using the enclosed umbraco key.</p>
 <p>125-145</p>	<p><b>Round legs</b></p> <p>5420 Alu-leg with height adjustment 125-145 mm, 1 pcs. 41</p> <p>5419 Alu-leg with height adjustment 180-200 mm, 1 pcs. 60</p> <p>We recommend using 5 legs for width 1072 mm.</p>
 <p>92</p>	<p><b>Square legs</b></p> <p>5418 Square legs in steel with adjustable foot, 1 pcs. 19</p> <p>We recommend using 5 legs for module in width 1072 mm.</p>

Prices in EURO







## V Accessories





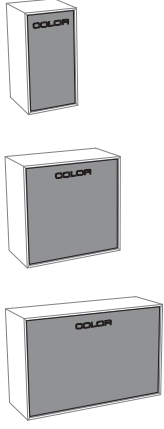

HPL Veneer      Linoleum XP laminate

	<p><b>Depth 350 mm top plates with bevelled edge</b></p> <p>6490 Top plate for width 368 mm H 23 mm x L 418 mm x D 400 mm</p> <p>6491 Top plate for width 720 mm H 23 mm x L 770 mm x D 400 mm</p> <p>6489 Top plate for width 1072 mm H 23 mm x L 1122 mm x D 400 mm</p> <p>6492 Top plate for width 1440 mm H 23 mm x L 1490 mm x D 400 mm</p> <p>6493 Top plate for width 2160 mm H 23 mm x L 2210 mm x D 400 mm</p>	<p>109      208</p> <p>125      225</p> <p>212      312</p> <p>327      487</p> <p>364      564</p>
	<p><b>Depth 400 mm top plates with bevelled edge</b></p> <p>6495 Top plate for width 368 mm H 23 mm x L 418 mm x D 450 mm</p> <p>6496 Top plate for width 720 mm H 23 mm x L 770 mm x D 450 mm</p> <p>6499 Top plate for width 1072 mm H 23 mm x L 1122 mm x D 450 mm</p> <p>6497 Top plate for width 1440 mm H 23 mm x L 1490 mm x D 450 mm</p> <p>6498 Top plate for width 2160 mm H 23 mm x L 2210 mm x D 450 mm</p>	<p>109      208</p> <p>125      225</p> <p>212      312</p> <p>327      487</p> <p>364      564</p>
	<p><b>Surcharge</b></p> <p>5553 Fronts with linoleum or XP mat laminate, per door / drawer insert</p> <p>5469 Assembly bracket for top plate (bone)</p>	<p><b>Price</b></p> <p>34</p> <p>58</p>
	<p><b>Handles without surcharge</b> (Choose freely between these handles - all fronts are with handles)</p> <p>5451 Knob handle in white, black, mat chrome or polished chrome</p> <p>5456 Knob handle with grooves</p> <p>6400_0500 V handle, polished chrome</p> <p>6400_0200 V handle, mat chrome (Standard handle, unless otherwise stated)</p> <p>6400_0300 V handle, black</p> <p>6400_0400 V handle, white</p> <p>5450 Quadro handle in white, black, polished chrome, brass or mat chrome</p> <p>6401_0000 T handle, mat alu</p> <p>5465 Push bracket for door - not for storage with wheels</p>	
	<p><b>Handles with surcharge</b></p> <p>5463 Milled handle, Ø 50 / 40 mm in brushed steel, black, or brass</p> <p>5466 Push bracket for drawers, 1 drawer</p> <p>The price is a surcharge.</p>	<p>18</p> <p>12</p>

## V Accessories

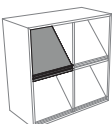
**Price**

 · 332 · · 332 ·	<b>Drawer insert</b> 6504 Insert with 4 drawers D 350 mm - <u>A4 paper</u> does not fit this depth 389 6514 Insert with 4 drawers D 400 mm 389																				
 · 332 · · 332 ·	<b>Drawer insert</b> 6502 Insert with 3 drawers D 350 mm - <u>A4 paper</u> does not fit this depth 320 6512 Insert with 3 drawers D 400 mm 320																				
 · 332 · · 332 ·	<b>Drawer insert</b> 6503 Insert with 2 drawers D 350 mm - <u>A4 paper</u> does not fit this depth 282 6513 Insert with 2 drawers D 400 mm 282																				
 · 332 · · 332 ·	<b>Suspension file</b> 6515 Suspension file with front D 400 mm 214 6516 Frame for suspension file 52																				
 · 332 · · 332 ·	<b>Letter trays</b> 6517 Wooden insert with 6 trays D 350 mm 552 6518 Wooden insert with 6 trays D 400 mm 552 6519 Black powder coated steel insert with 6 trays D 400 mm 349																				
	<b>Nordic Nature backing in high pressure laminate (HPL)</b> 6654 1-room high (1-room wide) 91 6655 2-room high (1-room wide) 151 6656 3-room high (1-room wide) 190 6657 1-room high (2-room wide) 91 6658 2-room high (2-room wide) 151 6659 3-room high (2-room wide) 190 6660 1-room high (3-room wide) 190 6661 2-room high (3-room wide) 252 6662 3-room high (3-room wide) 313 Prices on backing in high pressure laminate is a surcharge.																				
 · 332 · · 332 · · 332 · 684 · 1036 · Veneer Acrylic Laminate	<table border="1"> <thead> <tr> <th colspan="2"></th> <th>Laminate Nordic Nature Acrylic</th> <th>Veneer</th> </tr> </thead> <tbody> <tr> <td colspan="4"><b>Doors, 1-room wide</b></td> </tr> <tr> <td>6580</td> <td>Door, 1-room high, 1 pcs.</td> <td>93</td> <td>110</td> </tr> <tr> <td>6581</td> <td>Door, 2-room high, 1 pcs.</td> <td>130</td> <td>169</td> </tr> <tr> <td>6585</td> <td>Door, 3-room high, 1 pcs.</td> <td>195</td> <td>235</td> </tr> </tbody> </table>			Laminate Nordic Nature Acrylic	Veneer	<b>Doors, 1-room wide</b>				6580	Door, 1-room high, 1 pcs.	93	110	6581	Door, 2-room high, 1 pcs.	130	169	6585	Door, 3-room high, 1 pcs.	195	235
		Laminate Nordic Nature Acrylic	Veneer																		
<b>Doors, 1-room wide</b>																					
6580	Door, 1-room high, 1 pcs.	93	110																		
6581	Door, 2-room high, 1 pcs.	130	169																		
6585	Door, 3-room high, 1 pcs.	195	235																		

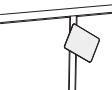
<b>V Accessory</b>		<b>Laminate</b>	<b>Veneer</b>	<b>Nordic Nature</b>
	<b>Divider</b>			
	6523 1-room high, D 350 mm	76	91	120
	6524 2-room high, D 350 mm	88	104	139
	6525 3-room high, D 350 mm	98	118	157
	6526 1-room high, D 400 mm	76	91	120
	6527 2-room high, D 400 mm	88	104	139
	6528 3-room high, D 400 mm	98	118	157
	<b>Shelves, D 350 mm</b>			
	6540 Shelf for bookcase, W 336 x D 326 mm	47	56	113
	6541 Shelf for cabinet, W 336 x D 308 mm	47	56	113
	<b>Shelves, D 400 mm</b>			
	6545 Shelf for bookcase, W 336 x D 376 mm	47	56	113
	6546 Shelf for cabinet, W 336 x D 358 mm	47	56	113
	<b>Journal shelf for bookcases</b>			
	6548 Journal shelf for D 350 mm, 1 pcs. W 336 x D 430 mm	106	127	136
	6549 Journal shelf for D 400 mm, 1 pcs. W 336 x D 441 mm	106	127	136
  	<b>5120</b>	<b>Locks</b>		<b>Price</b>
		5119 Lock, right door		41
		5120 Lock, left door, drawers and pull out cabinets		41
		6123 Lock for acrylic door (incl. hole)		40
		5129 Hole for lock in acrylic door - <u>only</u> hole		17
		5134 Hole for lock for RUKO lock in standard door - <u>only</u> hole		7
		5132 Combination lock public mode (black), right door - can not be retrofitted		48
		5136 Combination lock public mode (black), left door - can not be retrofitted		48
		5146 Combination lock (black), right door - can not be retrofitted		48
		5147 Combination lock (black), left door - can not be retrofitted		48
		<b>Flexlock* (Private Mode) (compatible with Mifare**)</b>		
		5140 Flexlock incl. mounted battery		195
		5142 User card for Flexlock, 1 pcs.		12
		5143 Flexlock service card, 1 pcs.		27
		5144 Flexlock programming card, 1 pcs.		27
		5148 Flexlock Any User card (Public Mode), 1 pcs.		46
		5149 Flexlock battery (extra), 1 pcs.		9
		<b>Cube Mifare lock** (Mifare Classic EV1 - EM4102 / Mifare Classic), remember handle or push</b>		
		<b>5112 Cube Mifare lock incl. 1 battery, 1 user card, 1 user fob</b>		130
		5113 Cube Mifare user card, 1 pcs.		24
		5114 Cube Mifare manager card, 1 pcs.		24
		5115 Cube Mifare user fob, 1 pcs.		24

Veneer : ash, beech, maple or oak + 25% surcharge for walnut.

\* To prolong battery life, we recommend doors are hinged on the same side when using electronic locks.

\*\* Mifare : 13,56 MHz : Mifare Classic 1k, Mifare Classic 4k, Mifare DESFire EV1 & EV2.

Prices in EURO



## V PULL-OUT CABINET



### V pull-out cabinets in general :

- Pull-out cabinets made in 16 mm plates
- 6 cabinet colors in laminate
- 5 cabinet colors in veneer
- 2 heights
- D 900 mm
- Fully extendable
- Back panel in 16 mm plates
- 2 mm impact-resistant ABS edge (laminate cabinet)
- 2 mm wooden edge (veneer cabinet)
- 33 colors in laminate - of which 20 are high pressure laminate
- Nordic Nature fronts in high pressure laminate
- Soft close
- 5 different handles
- Delivered assembled - only handles are to be mounted
- 10 years warranty

Cabinet available in :

- **Laminate** : Opaque White, Montana Grey, Platinum Grey, Anthracite Grey, Volcanic Black, Lindberg Oak or Congo
- **Veneer** : ash, beech, maple, oak or walnut\*

Surface - front :

- Standard laminate
- Nordic Nature (HPL)
- Veneer
- XP mat laminate\*
- Linoleum\*

Equipment for pull-out cabinet :

- Doors
  - Drawers
  - Letter trays
  - Suspension file
- made with milled handles or push brackets

\* Note surcharge see page 71.

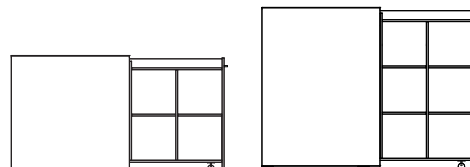

**V Pull-out cabinet** **Laminate** **Veneer**

	<p><b>Fully extendable pull-out cabinet - low</b>          6164 Pull out cabinet - low          H 882 mm x W 441 mm x D 900 / 1620 mm          Please inform right / left when ordering (see illustration).</p>	<p>1.138</p>	<p>1.394</p>
--	---	--------------	--------------

	<p><b>Fully extendable pull-out cabinet - high</b>          6174 Pull out cabinet - high          H 1234 mm x W 441 mm x D 900 / 1620 mm          Please inform right / left when ordering (see illustration).</p>	<p>1.198</p>	<p>1.458</p>
--	--	--------------	--------------

<p><b>Illustration</b></p>	<p><b>Please inform materials on :</b></p> <ol style="list-style-type: none"> <li>1 Cabinet</li> <li>2 Corner list</li> <li>3 Inner cabinet</li> <li>4 Front</li> </ol> <p>Please inform right / left when ordering (see illustration).</p>		
----------------------------	---	--	--

	<p><b>Handles without surcharge</b></p> <p>6400_0500 V handle, polished chrome          6400_0200 V handle, mat chrome (Standard handle, unless otherwise stated)          6400_0300 V handle, black          6400_0400 V handle, white          5450 Quadro handle in white, black, polished chrome, brass or mat chrome          6401_0000 T handle, mat alu</p> <p>Choose freely between these handles - all fronts are with handles.</p>		
--	--	--	--

	<p><b>Drawer insert with 4 drawers</b></p> <p>6177 Insert with 4 drawers for a pull-out cabinet</p>	<p><b>Price</b> 468</p>
--	---	-----------------------------



	<p><b>Drawer insert with 3 drawers</b></p> <p>6175 Insert with 3 drawers for a pull-out cabinet</p>	<p>377</p>
--	---	------------

	<p><b>Drawer insert with 2 drawers</b></p> <p>6176 Insert with 2 drawers for a pull-out cabinet</p>	<p>321</p>
--	---	------------

	<p><b>Suspension file</b></p> <p>6520 Suspension file <u>without</u> front for a pull-out cabinet          6178 Suspension file <u>with</u> front for a pull-out cabinet</p>	<p>179 214</p>
--	--	--------------------

## V Accessories

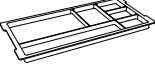
**Price**

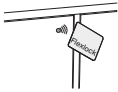
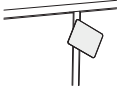
	<p><b>Letter trays</b></p> <p>6518 Wooden insert with 6 trays D 400 mm 552</p> <p>6519 Black powder coated steel insert with 6 trays D 400 mm 349</p>
	<p><b>Milled pen tray</b></p> <p>5180 Milled pen tray in the top of the inner cabinet 62</p>
	<p><b>Locks</b></p> <p>5120 Lock for pull-out cabinet, 1 pcs. 41</p> <p>5134 Hole for RUKO lock - <u>only</u> hole 7</p>
	<p><b>Flexlock* (Private Mode)</b> (compatible with Mifare**)</p> <p>5140 Flexlock incl. 1 user card 195</p> <p>5142 Extra user card for Flexlock, 1 pcs. 12</p> <p>5143 Flexlock service card, 1 pcs. 27</p> <p>5144 Flexlock programming card, 1 pcs. 27</p> <p>5148 Flexlock Any User card (Public Mode), 1 pcs. 46</p> <p>5149 Flexlock battery (extra), 1 pcs. 9</p>
	<p><b>Cube Mifare lock**</b> (Mifare Classic EV1 - EM4102 / Mifare Classic), remember handle or push</p> <p><b>5112 Cube Mifare lock incl. 1 battery, 1 user card, 1 user fob</b> 130</p> <p>5113 Cube Mifare user card, 1 pcs. 24</p> <p>5114 Cube Mifare manager card, 1 pcs. 24</p> <p>5115 Cube Mifare user fob, 1 pcs. 24</p>
	<p><b>Surcharge</b></p> <p>5553 Fronts with linoleum or XP mat laminate 34</p> <p>5596 Colored inner cabinet (Nordic Nature (HPL)) 205</p>

Prices in EURO

\* To prolong battery life, we recommend doors are hinged on the same side when using electronic locks.

\*\* Mifare : 13,56 MHz : Mifare Classic 1k, Mifare Classic 4k, Mifare DESFire EV1 &amp; EV2.



## OFFICE ACCESSORIES



### Trolley

Plates in :

- **12 mm compact laminate :**  
Opaque White with a black core, Platinum Grey with a black core or Volcanic Black with a black core
- **17 mm with laminate (HPL):** Opaque White, Montana Grey, Platinum Grey, Anthracite Grey, Slate Grey, Volcanic Black or Lindberg Oak
- **17 mm with veneer :** ash, beech, maple, oak or walnut

### Free standing screen

Upholstered with Hush (Gabriel) :

- Grey (60158)
- Black (60900)

Feet available in :

- **Nordic Nature (Lacquered)**
- **Veneer :** ash, beech, maple, oak or walnut

### The trolley in general :

- Frame in brushed stainless steel or black powder coated steel
- Castors with rubber tires which can turn 360°
- Plates in compact laminate, with standard laminate (HPL) or veneer
- 5 years warranty

### Free standing screen in general :

- Free standing screen with castors
- Feet in 27 mm plywood
- 2 heights and 3 widths
- Upholstered with Hush (Gabriel)
- 5 years warranty

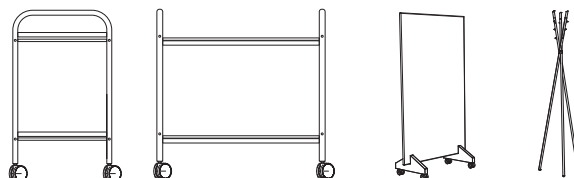

# OFFICE ACCESSORIES

<b>Frame in brushed stainless steel</b>	<b>Frame in black powder coated steel</b>
---	---

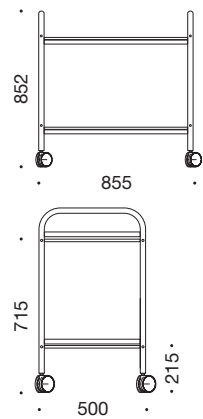

**Trolley**

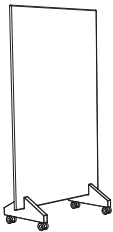
3440	Trolley, castors with rubber tires and plates in Opaque White, Platinum Grey or Volcanic Black 12 mm compact laminate with a black core	1.126	1.126
3441	Trolley, castors with rubber tires and plates in 17 mm with standard laminate (HPL) with ABS edges	1.126	1.126
3442	Trolley, castors with rubber tires and plates in 17 mm with veneer with solid wooden edges	1.126	1.126

**Free standing screen, H 1560 mm**

		<b>Price</b>
5970	W 800 mm	606
5971	W 1000 mm	649
5972	W 1200 mm	692
5973	W 1400 mm	736
5974	W 1600 mm	779

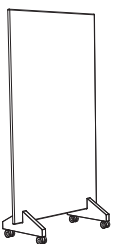
The free standing screen is upholstered with Cura (Gabriel): grey (60110) / slate grey (60019) / black (60999) or Hush (Gabriel): grey (60158) / black (60900).  
 Free standing screens over W 1200 mm are upholstered with Cura Screen (Gabriel): grey (60410) / slate grey (60419) or Hush (Gabriel): grey (60158) / black (60900).

**Free standing screen, H 1710 mm**

5981	W 800 mm	657
5982	W 1000 mm	710
5983	W 1200 mm	760
5987	W 1400 mm	812
5988	W 1600 mm	863

The free standing screen is upholstered with Cura (Gabriel): grey (60110) / slate grey (60019) / black (60999) or Hush (Gabriel): grey (60158) / black (60900).  
 Free standing screens over W 1200 mm are upholstered with Cura Screen (Gabriel): grey (60410) / slate grey (60419) or Hush (Gabriel): grey (60158) / black (60900).

**Surcharge**

5950	Choice of other color (free standing screens)	28
------	---	----

**Coat stand in black metal and wooden hooks in oak**

7970	Coat stand	197
------	------------	-----

## UP DESKS



Table top available in :

- **Veneer** : ash, beech, cherry, maple, oak or walnut
- **Standard laminate (HPL)**: Opaque White, Montana Grey, Platinum Grey, Anthracite Grey, Slate Grey, Volcanic Black or Lindberg Oak
- **Nordic Nature (HPL)**
- **XP mat laminate**
- **Linoleum**

7 x lacquer on veneer and  
3 x lacquer on edges.

Handset :

- Standard up / down
- Programmable\*

Easy to assemble - the frame is  
unassembled in a compact box.

\* Note surcharge see page 77-  
78.

### UP desks in general :

- Columns with sit-stand function
- Rectangular 3-stage columns, 50 x 80 mm
- Feet with adjustable shoes, L 700 mm
- Sit / stand frame in white, alu or black powder coated steel
- 9 table top shapes in many sizes
- Table top in 23 mm MDF with bevelled edges
- Choose between 4 different surfaces for the table tops
- Radius 20 on corners
- Height adjustment : 618-1268 mm
- Lifts 60 kg per column
- Anticollision
- Soft start / stop
- Low noise motor
- Rail free construction
- 0,1 W in standby
- CE - marked and EN 527-1\_2 certified
- 5 years warranty

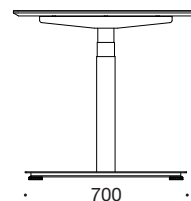
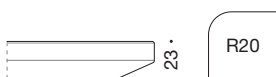



**UP Desks**

**Price**

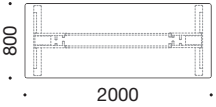
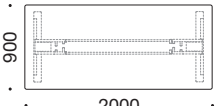
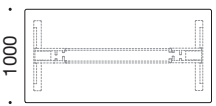
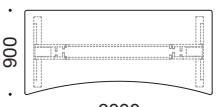
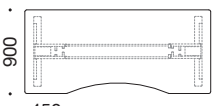
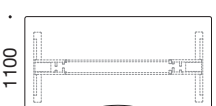
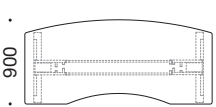
 <p>7497+7496 can be mounted</p>	<p><b>Rectangular</b></p> <p>6720 2000 x 800 mm 6718 1800 x 800 mm 6716 1600 x 800 mm 6714 1400 x 800 mm 6712 1200 x 800 mm</p>	<p><b>Surface and material</b></p> <p>HPL, veneer, Nordic Nature (HPL) 859 Linoleum or XP mat laminate 986</p>
 <p>7497+7496 can be mounted</p>	<p><b>Rectangular</b></p> <p>6740 2000 x 900 mm 6738 1800 x 900 mm 6736 1600 x 900 mm 6734 1400 x 900 mm 6732 1200 x 900 mm</p>	<p><b>Surface and material</b></p> <p>HPL, veneer, Nordic Nature (HPL) 859 Linoleum or XP mat laminate 986</p>
 <p>7497+7496 can be mounted</p>	<p><b>Rectangular</b></p> <p>6730 2000 x 1000 mm 6728 1800 x 1000 mm 6726 1600 x 1000 mm 6724 1400 x 1000 mm 6722 1200 x 1000 mm</p>	<p><b>Surface and material</b></p> <p>HPL, veneer, Nordic Nature (HPL) 859 Linoleum or XP mat laminate 986</p>
 <p>Whole arch D 150 mm. 7497+7496 can be mounted</p>	<p><b>Whole arch</b></p> <p>6810 2000 x 900 mm 6808 1800 x 900 mm 6806 1600 x 900 mm 6804 1400 x 900 mm 6802 1200 x 900 mm</p>	<p><b>Surface and material</b></p> <p>HPL, veneer, Nordic Nature (HPL) 859 Linoleum or XP mat laminate 986</p>
 <p>Stomach arch D 120 mm 7497+7496 can be mounted</p>	<p><b>Stomach arch</b></p> <p>6820 2000 x 900 mm 6818 1800 x 900 mm 6816 1600 x 900 mm 6814 1400 x 900 mm 6812 1200 x 900 mm</p>	<p><b>Surface and material</b></p> <p>HPL, veneer, Nordic Nature (HPL) 859 Linoleum or XP mat laminate 986</p>
 <p>Stomach arch D 150 mm. 7497+7496 can be mounted</p>	<p><b>Stomach arch</b></p> <p>6830 2000 x 1100 mm 6828 1800 x 1100 mm 6826 1600 x 1100 mm 6824 1400 x 1100 mm 6822 1200 x 1100 mm</p>	<p><b>Surface and material</b></p> <p>HPL, veneer, Nordic Nature (HPL) 859 Linoleum or XP mat laminate 986</p>
 <p>Stomach arch D 120 mm. 7497+7496 can <u>not</u> be mounted</p>	<p><b>Stomach + meeting arch</b></p> <p>6920 2000 x 900 mm 6918 1800 x 900 mm 6916 1600 x 900 mm 6914 1400 x 900 mm 6912 1200 x 900 mm</p>	<p><b>Surface and material</b></p> <p>HPL, veneer, Nordic Nature (HPL) 859 Linoleum or XP mat laminate 986</p>

Prices in EURO





# UP Desks

Price

<p>Stomach arch D 150 mm. 7497+7496 can be mounted</p>	<p><b>Stomach + meeting arch</b></p> <p>6930 2000 x 1100 mm 6928 1800 x 1100 mm 6926 1600 x 1100 mm 6924 1400 x 1100 mm 6922 1200 x 1100 mm</p>	<p><b>Surface and material</b></p> <p>HPL, veneer, Nordic Nature (HPL) 859 Linoleum or XP mat laminate 986</p>
<p>Whole arch D 150 mm. 7497+7496 can be mounted</p>	<p><b>Whole + meeting arch</b></p> <p>6940 2000 x 1100 mm 6938 1800 x 1100 mm 6936 1600 x 1100 mm 6934 1400 x 1100 mm 6932 1200 x 1100 mm</p>	<p><b>Surface and material</b></p> <p>HPL, veneer, Nordic Nature (HPL) 859 Linoleum or XP mat laminate 986</p>
<p>7497+7496 can <u>not</u> be mounted</p>	<p><b>Cluster</b></p> <p>6906 Cluster desk, 1 pcs. Format for 3 persons.</p>	<p><b>Surface and material</b></p> <p>HPL, veneer, Nordic Nature (HPL) 859 Linoleum or XP mat laminate 986</p>
<p>7497+7496 can <u>not</u> be mounted</p>	<p><b>Cluster</b></p> <p>6907 Cluster desk, 1 pcs. Format for 4 persons.</p>	<p><b>Surface and material</b></p> <p>HPL, veneer, Nordic Nature (HPL) 859 Linoleum or XP mat laminate 986</p>
<p>Stomach arch D 350 mm. 7497 can be mounted</p>	<p><b>Deep stomach arch</b></p> <p>6893 Left 2000 mm 6894 Right 2000 mm 6853 Left 1800 mm 6854 Right 1800 mm</p>	<p><b>Surface and material</b></p> <p>HPL, veneer, Nordic Nature (HPL) 859 Linoleum or XP mat laminate 986</p>
<p>Stomach arch D 300 mm. 7497 can be mounted</p>	<p><b>Sideways stomach arch</b></p> <p>6873 Left 2000 mm 6874 Right 2000 mm 6871 Left 1800 mm 6872 Right 1800 mm</p>	<p><b>Surface and material</b></p> <p>HPL, veneer, Nordic Nature (HPL) 859 Linoleum or XP mat laminate 986</p>
	<p><b>Surcharge</b></p> <p>3287 Fenix laminate up to 1200 mm (surcharge to the linoleum price) 90 3297 Fenix laminate, 1201-2200 mm (surcharge to the linoleum price) 136 3277 Fenix laminate, 2201-3000 mm (surcharge to the linoleum price) 181 3273 ABS/veneer on curved edge up to 2200 mm 139 3274 ABS/veneer on curved edge from 2201-2800 mm 223</p>	

## UP Accessories

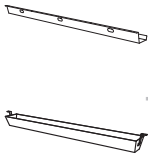

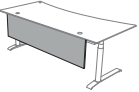
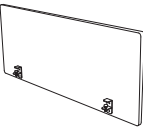





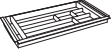
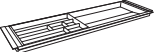

**Price**

	<p><b>Surcharge</b></p> <p>3407 Set of castors, set of 4 psc. 90</p> <p>3410 Customized table top 84</p> <p>7483 Milling cable hole in table top (<u>only</u> hole) 8</p> <p>3260 Linoleum/HPL/XP over wooden edge, rectangular table top 108</p> <p>3264 Linoleum/HPL/XP over wooden edge, table top with arch 215</p>
	<p><b>Cable tray</b></p> <p>8948 Cable tray for desk length 1800 / 2000 mm (L 1460 mm) 63</p> <p>8947 Cable tray for desk length 1600 mm (L 1150 mm) 56</p> <p>8949 Cable tray for desk length 1200 / 1400 mm (L 740 mm) 52</p> <p>8943 Tilttable cable tray for desk length 1800 / 2000 mm (L 1490 mm) 79</p> <p>8942 Tilttable cable tray for desk length 1600 mm (L 1290 mm) 76</p> <p>8941 Tilttable cable tray for desk length 1400 mm (L 1090 mm) 73</p> <p>Offered in the same colors as the frame : alu, white and black.</p>
	<p><b>Modesty screen / curtain</b></p> <p>5945 Modesty screen for desk length 2000 mm (1630 mm x 390 mm) 182</p> <p>5946 Modesty screen for desk length 1800 mm (1430 mm x 390 mm) 182</p> <p>5947 Modesty screen for desk length 1600 mm (1230 mm x 390 mm) 182</p> <p>5948 Modesty screen for desk length 1400 mm (1030 mm x 390 mm) 182</p> <p>5949 Modesty screen for desk length 1200 mm ( 830 mm x 390 mm) 182</p>
	<p><b>Front panel in 16 mm plates</b></p> <p>7470 Panel for desk length 2000 mm (1630 mm x 400 mm) 160</p> <p>7469 Panel for desk length 2000 mm (1630 mm x 250 mm) 144</p> <p>7468 Panel for desk length 1800 mm (1430 mm x 400 mm) 160</p> <p>7467 Panel for desk length 1800 mm (1430 mm x 250 mm) 128</p> <p>7466 Panel for desk length 1600 mm (1230 mm x 400 mm) 144</p> <p>7465 Panel for desk length 1600 mm (1230 mm x 250 mm) 111</p> <p>Front panel available in all cabinet colors, both laminate and veneer.</p>
	<p><b>Desk screen wall, D 30 mm</b></p> <p>5956 Desk screen wall incl. fittings, 800 x 550 mm 260</p> <p>5955 Desk screen wall incl. fittings, 1000 x 550 mm 284</p> <p>5954 Desk screen wall incl. fittings, 1200 x 550 mm 289</p> <p>5953 Desk screen wall incl. fittings, 1400 x 550 mm 317</p> <p>5952 Desk screen wall incl. fittings, 1600 x 550 mm 334</p> <p>5951 Desk screen wall incl. fittings, 1800 x 550 mm 350</p> <p><b>Acoustic desk screen with 20 mm mineral wool (A class), D 45 mm</b></p> <p>5953A Acoustic desk screen wall incl. fittings, 1400 x 550 mm 587</p> <p>5952A Acoustic desk screen wall incl. fittings, 1600 x 550 mm 619</p> <p>5951A Acoustic desk screen wall incl. fittings, 1800 x 550 mm 652</p> <p>Upholstered with Cura (Gabriel): grey (60110) / slate grey (60019) / black (60999) <b>or</b> Hush (Gabriel): grey (60158) / black (60900).</p> <p><b>Surcharge</b></p> <p>5950 Choice of other color (screen walls) 28</p>

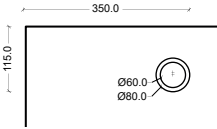
Prices in EURO

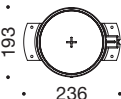

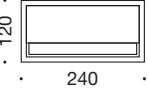
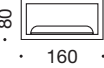
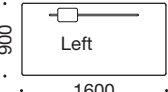
**UP Accessories**

**Price**

	<p><b>Powerstrip with alu case</b></p> <p>7500 Powerstrip incl. 6 x schuko plugs, USB-A, USB-C for charging</p>	<p>79</p>
 <p>7497</p>  <p>7496</p>  <p>7495</p>	<p><b>Black metal pen tray with pull-out, lock and plastic tray</b></p> <p>7497 Pen tray, L 475 mm (H 40 mm x L 475 mm x D 270 mm)</p> <p>7496 Pen tray, L 850 mm (H 40 mm x L 850 mm x D 270 mm)</p> <p><b>Plastic pen tray</b></p> <p>7495 Plastic pen tray with pull-out (H 32 mm x L 350 mm x D 175 mm)</p> <p>All pen trays can be retrofitted.</p>	<p>88</p> <p>111</p> <p>38</p>
 <p>• 60 •</p>  <p>• 80 •</p> <p><b>Default position</b></p>   <p>7444</p>  <p>• 193 • • 236 •</p> <p>7446</p>  <p>80</p> <p>7447</p>	<p><b>Cable grommets (Incl. milling of cable hole)</b></p> <p>7479 Cable grommets Ø 60 mm, white plastic</p> <p>7480 Cable grommets Ø 60 mm, black plastic</p> <p>7481 Cable grommets Ø 60 mm, alu</p> <p>7488 Cable grommets Ø 60 mm, polished chrome</p> <p>7478 Cable grommets Ø 60 mm, black metal</p> <p><b>Cable grommets (Incl. milling of cable hole)</b></p> <p>7440 Cable grommets Ø 80 mm, alu</p> <p>7442 Cable grommets Ø 80 mm, black plastic</p> <p>7443 Cable grommets Ø 80 mm, white plastic</p> <p><b>Wireless charger</b></p> <p>7444 Wireless charger with Qi technology. USB-A and USB-C outlet incl. EU power adapter, 15W fast charger (Incl. milling of a Ø 60 mm cable hole)</p> <p>7446 Invisible wireless charger which can charge through a desk (30 mm)</p> <p><b>Cube multi connector (Incl. milling of cable hole)</b></p> <p>7447 Cube multi connector (Ø 80 mm), black plastic</p> <p>1 schuko power outlet, 16A 230V~ max 3500W</p> <p>1 wireless charger (Qi charger)</p> <p>1 RJ45 outlet</p> <p>1 USB-A outlet (DC5V, 2.4A) + 1 USB-C outlet for charging</p>	<p>13</p> <p>13</p> <p>28</p> <p>28</p> <p>28</p> <p>28</p> <p>28</p> <p>13</p> <p>13</p> <p>55</p> <p>62</p> <p>85</p>
 <p>• 120 • • 240 •</p> <p>3425</p>  <p>• 80 • • 160 •</p> <p>3426</p>  <p>• 900 • • 1600 •</p> <p>7445</p>	<p><b>Cable grommet (Incl. milling of cable hole)</b></p> <p>3425 Cable grommet in black metal (240 mm x 120 mm)</p> <p>3426 Cable grommet in black metal (160 mm x 80 mm)</p> <p>7445 Cable routing with slit (only for table tops <u>without</u> a meeting arch)</p>	<p>87</p> <p>52</p> <p>165</p>
	<p><b>CPU-holder</b></p> <p>7482 Large CPU-holder (H 200-460 mm x W 60-190 mm)</p> <p>8009MIC Small CPU-holder (H 175-310 mm x W 30-100 mm)</p> <p>Available in white, alu or black.</p>	<p>48</p> <p>48</p>

**UP Accessories**

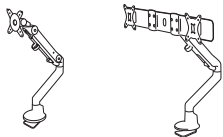
**Price**

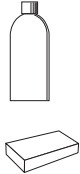
 <p>7980      7981</p>	<p><b>Monitor arm</b></p> <p>7980      Monitor arm in black metal (Max load 13 kg)      223</p> <p>7981      Dual monitor arm with crossbar (Max 6 kg per screen)      303</p> <p>Please specify if you want us to pre-drill a mounting hole in the table top.</p>
	<p><b>Handset</b></p> <p>6005      Programmable handset, 3 memory positions for UP desks      60</p>
	<p><b>Cable organizer</b></p> <p>7973      Cable organizer, 1450 mm      46</p>
	<p><b>Cleaning products</b></p> <p>3414      Linoleum cleaner 1L      31</p> <p>3415      Laminate cleaner 1L      23</p> <p>3445      Sponge for surfaces      4</p>

# RAW DESKS



### Wall mounted desk :

- Rectangular LINAK column (DL6)
- Rectangular table top
- Height adjustment 640-1280 mm



### 1-column desk :

- Rectangular LINAK column (DL6)
- Feet with adjustable shoes, L 635 mm
- Rectangular table top
- Height adjustment 640-1280 mm



### Desk with 2 or 3 columns :

- Rectangular LINAK columns (DL6 High speed 60 mm/sec)
- Round LINAK columns (DL11)
- Feet with adjustable shoes, L 650 mm
- Piezo technology
- 11 table top shapes
- Height adjustment 640-1280 mm
- Fixed frame is possible, H 740 mm



### Bench desk :

- Double desk
- Separate control box for each table top
- Rectangular LINAK columns (DL6)
- Rectangular table tops
- Height adjustment 590-1250 mm



Table tops available in :

- **Veneer** : ash, beech, cherry, maple, oak or walnut
- **Standard laminate (HPL)**: Opaque White, Montana Grey, Platinum Grey, Anthracite Grey, Slate Grey, Volcanic Black or Lindberg Oak
- **Nordic Nature (HPL)**
- **XP mat laminate**
- **Linoleum**

7 x lacquer on veneer and 3 x lacquer on edges.

Frame and columns available in :

- Rectangular 50x80 mm (DL6 / DL6 High speed): white, alu or black powder coat
- Round Ø 70 mm (DL11): white, alu or black powder coat

Handset :

- Intuitive up / down
- Memory with Bluetooth\*
- Fingertouch\*

RAW desks in general :

- Table top in 23 mm MDF
- Bevelled edges
- Radius 20 on corners
- Columns with sit-stand function
- 3-stage columns
- Intuitive control as standard
- Soft start / stop
- Rail-free construction
- PVC free
- CE-marked
- EN 527-1\_2 certified
- Low noise motor
- Lifts approx. 80 kg per column
- 100% made in Denmark
- 5 years warranty

Assembly guide enclosed

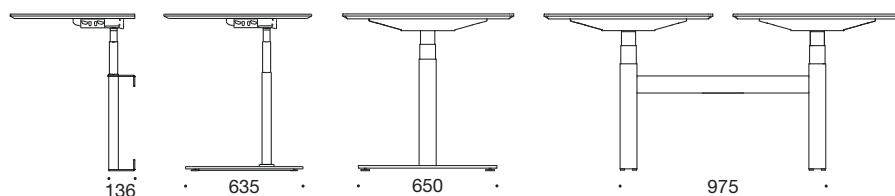

\* Note surcharge see page 85.

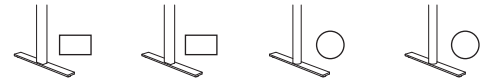



**RAW** Desks

**HPL Linak DL6**    **Linoleum Linak DL6**    **HPL Linak DL11**    **Linoleum Linak DL11**

	<b>EU Ecolabel RAW desk, rectangular incl. cable tray and 2 plastic cable grommets</b>					
	4718ECO	1800 x 800 mm	1.100	1.228	1.156	1.284
	4716ECO	1600 x 800 mm	1.093	1.221	1.149	1.277
	4714ECO	1400 x 800 mm	1.089	1.217	1.145	1.273
	4712ECO	1200 x 800 mm	1.089	1.217	1.145	1.273
	<b>EU Ecolabel RAW desk, stomach arch incl. cable tray and 2 plastic cable grommets</b>					
	4816ECO	1600 x 900 mm	1.093	1.221	1.149	1.277
	4814ECO	1400 x 900 mm	1.089	1.217	1.145	1.273
	4812ECO	1200 x 900 mm	1.089	1.217	1.145	1.273
	Find the EU Ecolabel color chart on page 6.					

Fixed height H 740 mm   
  Linak DL6   
  Linak DL11

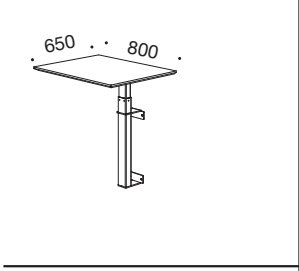
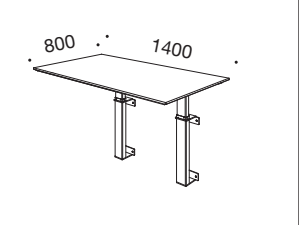
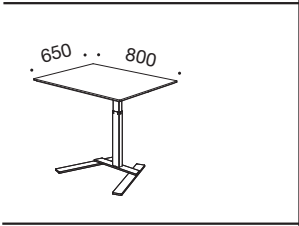
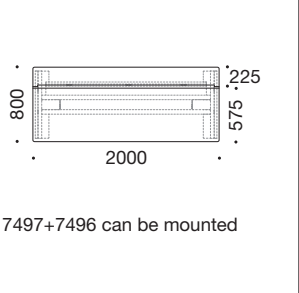
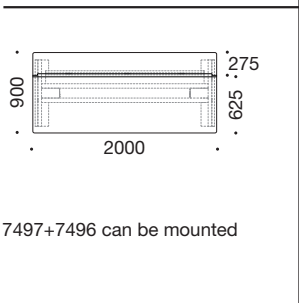
	<b>Wall mounted, 1-column</b>	<b>Surface and material</b>			
	4976 800 mm x 550 mm	HPL or veneer	-	647	-
	4978 800 mm x 650 mm	Linoleum or XP mat laminate	-	694	-
	4980 1000 mm x 650 mm				
	4982 1000 mm x 800 mm				
4984 1200 mm x 800 mm					
	<b>Wall mounted, 2-column</b>	<b>Surface and material</b>			
	4996 1400 mm x 800 mm	HPL or veneer	-	1.011	-
	4997 1600 mm x 800 mm	Linoleum or XP mat laminate	-	1.138	-
	4998 1800 mm x 800 mm				
	4999 2000 mm x 800 mm				
	<b>1-column</b>	<b>Surface and material</b>			
	4988 800 mm x 650 mm	HPL or veneer	-	823	-
	4990 1000 mm x 650 mm	Linoleum or XP mat laminate	-	870	-
	4992 1000 mm x 800 mm				
	4994 1200 mm x 800 mm				
	<b>Table top with split</b>	<b>Surface and material</b>			
	- incl. cable tray	HPL or veneer	1.103	1.406	1.464
	4620 2000 x 800 mm	Linoleum or XP mat laminate	1.232	1.532	1.590
	4618 1800 x 800 mm				
	4616 1600 x 800 mm				
	4614 1400 x 800 mm				
	4612 1200 x 800 mm				
7497+7496 can be mounted					
	<b>Table top with split</b>	<b>Surface and material</b>			
	- incl. cable tray	HPL or veneer	1.103	1.406	1.464
	4640 2000 x 900 mm	Linoleum or XP mat laminate	1.232	1.532	1.590
	4638 1800 x 900 mm				
	4636 1600 x 900 mm				
	4634 1400 x 900 mm				
	4632 1200 x 900 mm				
7497+7496 can be mounted					



**RAW** Desks

 Fixed height  
H 740 mm
  Linak  
DL6
  Linak  
DL11

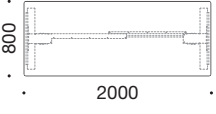
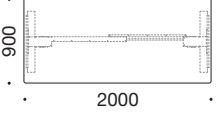
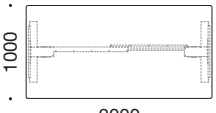
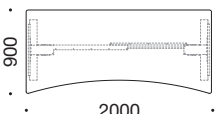
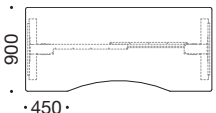
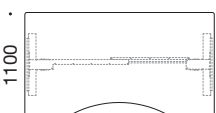
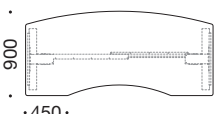
			Fixed height H 740 mm	Linak DL6	Linak DL11
 <p>7497+7496 can be mounted</p>	<p><b>Rectangular</b></p> <p>4720 2000 x 800 mm 4718 1800 x 800 mm 4716 1600 x 800 mm 4714 1400 x 800 mm 4712 1200 x 800 mm</p>	<p><b>Surface and material</b></p> <p>HPL, veneer, Nordic Nature Linoleum or XP mat laminate</p>	699 830	1.011 1.138	1.042 1.195
 <p>7497+7496 can be mounted</p>	<p><b>Rectangular</b></p> <p>4740 2000 x 900 mm 4738 1800 x 900 mm 4736 1600 x 900 mm 4734 1400 x 900 mm 4732 1200 x 900 mm</p>	<p><b>Surface and material</b></p> <p>HPL, veneer, Nordic Nature Linoleum or XP mat laminate</p>	699 830	1.011 1.138	1.042 1.195
 <p>7497+7496 can be mounted</p>	<p><b>Rectangular</b></p> <p>4730 2000 x 1000 mm 4728 1800 x 1000 mm 4726 1600 x 1000 mm 4724 1400 x 1000 mm 4722 1200 x 1000 mm</p>	<p><b>Surface and material</b></p> <p>HPL, veneer, Nordic Nature Linoleum or XP mat laminate</p>	699 830	1.011 1.138	1.042 1.195
 <p>Whole arch D 150 mm. 7497+7496 can be mounted</p>	<p><b>Whole arch</b></p> <p>4810 2000 x 900 mm 4808 1800 x 900 mm 4806 1600 x 900 mm 4804 1400 x 900 mm 4802 1200 x 900 mm</p>	<p><b>Surface and material</b></p> <p>HPL, veneer, Nordic Nature Linoleum or XP mat laminate</p>	699 830	1.011 1.138	1.042 1.195
 <p>Stomach arch D 120 mm 7497+7496 can be mounted</p>	<p><b>Stomach arch</b></p> <p>4820 2000 x 900 mm 4818 1800 x 900 mm 4816 1600 x 900 mm 4814 1400 x 900 mm 4812 1200 x 900 mm</p>	<p><b>Surface and material</b></p> <p>HPL, veneer, Nordic Nature Linoleum or XP mat laminate</p>	699 830	1.011 1.138	1.042 1.195
 <p>Stomach arch D 150 mm 7497+7496 can be mounted</p>	<p><b>Stomach arch</b></p> <p>4830 2000 x 1100 mm 4828 1800 x 1100 mm 4826 1600 x 1100 mm 4824 1400 x 1100 mm 4822 1200 x 1100 mm</p>	<p><b>Surface and material</b></p> <p>HPL, veneer, Nordic Nature Linoleum or XP mat laminate</p>	699 830	1.011 1.138	1.042 1.195
 <p>Stomach arch D 120 mm 7497+7496 can <u>not</u> be mounted</p>	<p><b>Stomach + meeting arch</b></p> <p>4920 2000 x 900 mm 4918 1800 x 900 mm 4916 1600 x 900 mm 4914 1400 x 900 mm 4912 1200 x 900 mm</p>	<p><b>Surface and material</b></p> <p>HPL, veneer, Nordic Nature Linoleum or XP mat laminate</p>	699 830	1.011 1.138	1.042 1.195



# RAW Desks

Fixed height H 740 mm  
 Linak DL6  
 Linak DL11

			Fixed height H 740 mm	Linak DL6	Linak DL11			
<p>Stomach arch D 150 mm 7497+7496 can be mounted</p>	<b>Stomach + meeting arch</b> 4930 2000 x 1100 mm 4928 1800 x 1100 mm 4926 1600 x 1100 mm 4924 1400 x 1100 mm 4922 1200 x 1100 mm	<b>Surface and material</b> HPL, veneer, Nordic Nature Linoleum or XP mat laminate	699 830	1.011 1.138	1.042 1.195			
	<p>Whole arch D 150 mm 7497+7496 can be mounted</p>	<b>Whole + meeting arch</b> 4940 2000 x 1100 mm 4938 1800 x 1100 mm 4936 1600 x 1100 mm 4934 1400 x 1100 mm 4932 1200 x 1100 mm	<b>Surface and material</b> HPL, veneer, Nordic Nature Linoleum or XP mat laminate	699 830	1.011 1.138	1.042 1.195		
		<p>Stomach arch D 350 mm 7497 can be mounted</p>	<b>Stomach arch D 350 mm</b> 4893 Left 2000 mm 4894 Right 2000 mm 4853 Left 1800 mm 4854 Right 1800 mm	<b>Surface and material</b> HPL, veneer, Nordic Nature Linoleum or XP mat laminate	699 830	1.011 1.138	1.042 1.195	
			<p>Stomach arch D 300 mm 7497 can be mounted</p>	<b>Stomach arch D 300 mm</b> 4873 Left 2000 mm 4874 Right 2000 mm 4871 Left 1800 mm 4872 Right 1800 mm	<b>Surface and material</b> HPL, veneer, Nordic Nature Linoleum or XP mat laminate	699 830	1.011 1.138	1.042 1.195
				<p>Stomach arch D 350 mm 7497 can be mounted</p>	<b>Terminal A</b> 4895 Left 2000 mm 4855 Left 1800 mm	<b>Surface and material</b> HPL, veneer, Nordic Nature Linoleum or XP mat laminate	1.100 1.358	1.584 1.877
<p>Stomach arch D 350 mm 7497 can be mounted</p>					<b>Terminal A</b> 4896 Right 2000 mm 4856 Right 1800 mm	<b>Surface and material</b> HPL, veneer, Nordic Nature Linoleum or XP mat laminate	1.100 1.358	1.584 1.877











# RAW Desks

Fixed height  
H 740 mm
  Linak  
DL6
  Linak  
DL11

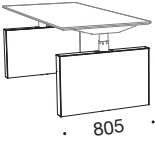
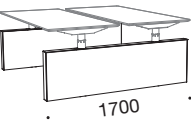
	<p><b>Terminal B</b></p> <p>4883 Left 2000 mm</p> <p>4881 Left 1800 mm</p>	<p><b>Surface and material</b></p> <p>HPL, veneer, Nordic Nature 1.100 1.584 1.698</p> <p>Linoleum or XP mat laminate 1.358 1.877 1.992</p>
	<p><b>Terminal B</b></p> <p>4884 Right 2000 mm</p> <p>4882 Right 1800 mm</p>	<p><b>Surface and material</b></p> <p>HPL, veneer, Nordic Nature 1.100 1.584 1.698</p> <p>Linoleum or XP mat laminate 1.358 1.877 1.992</p>
	<p><b>Cluster</b></p> <p>4906 Cluster desk, 1 pcs.</p> <p>Format for 3 persons.</p>	<p><b>Surface and material</b></p> <p>HPL, veneer, Nordic Nature 699 1.011 1.042</p> <p>Linoleum or XP mat laminate 830 1.138 1.195</p>
	<p><b>Cluster</b></p> <p>4907 Cluster desk, 1 pcs.</p> <p>Format for 4 persons.</p>	<p><b>Surface and material</b></p> <p>HPL, veneer, Nordic Nature 699 1.011 1.042</p> <p>Linoleum or XP mat laminate 830 1.138 1.195</p>
	<p><b>Bench desk</b></p> <p>4960 2000 x 800 mm</p> <p>4958 1800 x 800 mm</p> <p>4956 1600 x 800 mm</p> <p>4954 1400 x 800 mm</p> <p>4952 1200 x 800 mm</p>	<p><b>Surface and material</b></p> <p>HPL, veneer, Nordic Nature - 2.007 -</p> <p>Linoleum or XP mat laminate - 2.261 -</p>
	<p><b>Surcharge/accessories</b></p> <p>3596 RAW foot with top side in stainless brushed steel, per set 98</p> <p>3407 Set of castors, set of 4 psc. 90</p> <p>3410 Customized table top 84</p> <p>7483 Milling cable hole in table top (only hole) 8</p> <p>3260 Linoleum/HPL/XP over wooden edge, rectangular table top 108</p> <p>3262 Linoleum/HPL/XP over wooden edge, split table top 144</p> <p>3264 Linoleum/HPL/XP over wooden edge, table top with arch 215</p> <p>3287 Fenix laminate up to 1200 mm (surcharge to the linoleum price) 90</p> <p>3297 Fenix laminate, 1201-2200 mm (surcharge to the linoleum price) 136</p> <p>3277 Fenix laminate, 2201-3000 mm (surcharge to the linoleum price) 181</p> <p>3273 ABS/veneer on curved edge up to 2200 mm 139</p> <p>3274 ABS/veneer on curved edge from 2201-2800 mm 223</p>	<p><b>Price</b></p>

# RAW Accessories

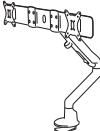
**Price**

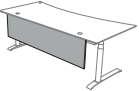
 <p>4970</p>  <p>4975</p>	<p><b>Gable end for RAW desk incl. fitting, 805 x 500 x 90 mm</b></p> <p>4970 Price gr. 1: Additional purchase of gable end together with table, per end 391 Price gr. 2: Gable end for subsequent installation (incl. RAW feet), per end 447</p> <p><b>Gable end for RAW Bench desks</b></p> <p>4975 Gable end for RAW Bench desks incl. fittings, 1700 x 500 x 90 mm 508 Subsequent installation is possible without surcharge.</p> <p>Plate material is available in 7 laminate cabinet colors and 5 veneer cabinet colors. The gable has a steel frame in black powder coating. Note, only available for fixed frame or DL6.</p>
  <p>Tiltable</p>  <p>Bench</p>	<p><b>Cable tray, normal, tiltable or bench</b></p> <p>8948 Cable tray for desk length 1800 / 2000 mm (L 1460 mm) 63 8947 Cable tray for desk length 1600 mm (L 1150 mm) 56 8949 Cable tray for desk length 1200 / 1400 mm (L 740 mm) 52</p> <p>8943 Tiltable cable tray for desk length 1800 / 2000 mm (L 1490 mm) 79 8942 Tiltable cable tray for desk length 1600 mm (L 1290 mm) 76 8941 Tiltable cable tray for desk length 1400 mm (L 1090 mm) 73</p> <p>4948 Bench cable tray for desk length 1800 mm (L 1558 mm) 207 4946 Bench cable tray for desk length 1600 mm (L 1358 mm) 199 4944 Bench cable tray for desk length 1400 mm (L 1190 mm) 191</p> <p>The cable trays are offered in : alu, white and black.</p>
 <p>7980</p>  <p>7981</p>	<p><b>Monitor arm</b></p> <p>7980 Monitor arm in black metal (Max load 13 kg) 223 7981 Dual monitor arm with crossbar (Max 6 kg per screen) 303</p> <p>Please specify if you want us to pre-drill a mounting hole in the table top.</p>
	<p><b>Powerstrip with alu case</b></p> <p>7500 Powerstrip incl. 6 x schuko plugs, USB-A, USB-C for charging 79</p>
	<p><b>Modesty screen / curtain</b></p> <p>5945 Modesty screen for desk length 2000 mm (1630 mm x 390 mm) 182 5946 Modesty screen for desk length 1800 mm (1430 mm x 390 mm) 182 5947 Modesty screen for desk length 1600 mm (1230 mm x 390 mm) 182 5948 Modesty screen for desk length 1400 mm (1030 mm x 390 mm) 182 5949 Modesty screen for desk length 1200 mm ( 830 mm x 390 mm) 182</p>
	<p><b>Front panel in 16 mm plates</b></p> <p>7470 Panel for desk length 2000 mm (1630 mm x 400 mm) 160 7469 Panel for desk length 2000 mm (1630 mm x 250 mm) 144 7468 Panel for desk length 1800 mm (1430 mm x 400 mm) 160 7467 Panel for desk length 1800 mm (1430 mm x 250 mm) 128 7466 Panel for desk length 1600 mm (1230 mm x 400 mm) 144 7465 Panel for desk length 1600 mm (1230 mm x 250 mm) 111</p> <p>Front panel available in all cabinet colors, both laminate and veneer.</p>

Prices in EURO

# RAW Accessories



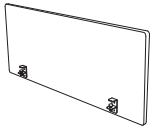
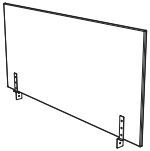



**Price**

  	<p><b>Desk screen wall, D 30 mm</b></p> <p>5956 Desk screen wall incl. fittings, 800 x 550 mm</p> <p>5955 Desk screen wall incl. fittings, 1000 x 550 mm</p> <p>5954 Desk screen wall incl. fittings, 1200 x 550 mm</p> <p>5953 Desk screen wall incl. fittings, 1400 x 550 mm</p> <p>5952 Desk screen wall incl. fittings, 1600 x 550 mm</p> <p>5951 Desk screen wall incl. fittings, 1800 x 550 mm</p> <p><b>Bench desk screen wall, D 30 mm</b></p> <p>5963 Desk screen wall incl. fittings, 1400 x 750 mm</p> <p>5962 Desk screen wall incl. fittings, 1600 x 750 mm</p> <p>5961 Desk screen wall incl. fittings, 1800 x 750 mm</p> <p><b>Acoustic desk screen with 20 mm mineral wool (A class), D 45 mm</b></p> <p>5953A Acoustic desk screen wall incl. fittings, 1400 x 550 mm</p> <p>5952A Acoustic desk screen wall incl. fittings, 1600 x 550 mm</p> <p>5951A Acoustic desk screen wall incl. fittings, 1800 x 550 mm</p> <p><b>Bench acoustic desk screen wall with 20 mm mineral wool (A class), D 45 mm</b></p> <p>5963A Acoustic desk screen wall incl. fittings, 1400 x 750 mm</p> <p>5962A Acoustic desk screen wall incl. fittings, 1600 x 750 mm</p> <p>5961A Acoustic desk screen wall incl. fittings, 1800 x 750 mm</p> <p>Upholstered with Cura (Gabriel): grey (60110) / slate grey (60019) / black (60999)  or Hush (Gabriel): grey (60158) / black (60900).</p> <p><b>Surcharge</b></p> <p>5950 Choice of other color (screen walls)</p>	<p>260</p> <p>284</p> <p>289</p> <p>317</p> <p>334</p> <p>350</p> <p>368</p> <p>384</p> <p>401</p> <p>587</p> <p>619</p> <p>652</p> <p>683</p> <p>715</p> <p>747</p> <p>28</p>
	<p><b>Black metal pen tray with pull-out, lock and plastic tray</b></p> <p>7497 Pen tray, L 475 mm (H 40 mm x L 475 mm x D 270 mm)</p> <p>7496 Pen tray, L 850 mm (H 40 mm x L 850 mm x D 270 mm)</p> <p><b>Plastic pen tray</b></p> <p>7495 Plastic pen tray with pull-out (H 32 mm x L 350 mm x D 175 mm)</p> <p>All pen trays can be retrofitted.</p>	<p>88</p> <p>111</p> <p>38</p>
	<p><b>LINAK accessories</b></p> <p>7988 Simple control, up / down (intuitive adjustment), anti-collision</p> <p>7989 Control DPi1C with auto-drive, anti-collision, display (Bluetooth) and up to 4 memory positions</p> <p>5701 Fingertouch (milled into the table top)</p> <p>7487 Cable for the computer for Linak Desk Control, 2 m</p> <p>7986 LINAK battery (can be charged through external control box)</p> <p>7987 LINAK charger for battery <b>DISCONTINUED</b></p> <p>5707 Surcharge: 80 mm/s high speed control panel</p>	<p>32</p> <p>79</p> <p>48</p> <p>63</p> <p>248</p> <p>48</p> <p>42</p>

Prices in EURO

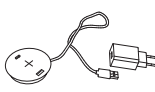
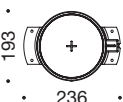
**RAW Accessories**

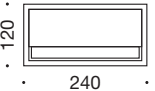
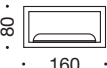
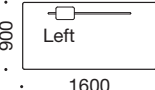
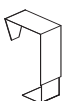
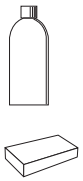
Price

 <p>• 60 •</p> <p>Ø60</p>  <p>• 80 •</p> <p>Ø80</p> <p>Default position</p>  <p>350.0</p> <p>115.0</p> <p>Ø60.0 Ø80.0</p>  <p>7444</p>  <p>• 193 • • 236 •</p> <p>7446</p>  <p>• 80 •</p> <p>7447</p>	<p><b>Cable grommets (Incl. milling of cable hole)</b></p> <p>7479 Cable grommets Ø 60 mm, white plastic 13</p> <p>7480 Cable grommets Ø 60 mm, black plastic 13</p> <p>7481 Cable grommets Ø 60 mm, alu 28</p> <p>7488 Cable grommets Ø 60 mm, polished chrome 28</p> <p>7478 Cable grommets Ø 60 mm, black metal 28</p> <p><b>Cable grommets (Incl. milling of cable hole)</b></p> <p>7440 Cable grommets Ø 80 mm, alu 28</p> <p>7442 Cable grommets Ø 80 mm, black plastic 13</p> <p>7443 Cable grommets Ø 80 mm, white plastic 13</p> <p><b>Wireless charger</b></p> <p>7444 Wireless charger with Qi technology. USB-A and USB-C outlet incl. EU power adapter, 15W fast charger (Incl. milling of a Ø 60 mm cable hole) 55</p> <p>7446 Invisible wireless charger which can charge through a desk (30 mm) 62</p> <p><b>Cube multi connector (Incl. milling of cable hole)</b></p> <p>7447 Cube multi connector (Ø 80 mm), black plastic 85</p> <p>1 schuko power outlet, 16A 230V max 3500W</p> <p>1 wireless charger (Qi charger)</p> <p>1 RJ45 outlet</p> <p>1 USB-A outlet (DC5V, 2.4A) + 1 USB-C outlet for charging</p>
 <p>• 120 • • 240 •</p> <p>3425</p>  <p>• 80 • • 160 •</p> <p>3426</p>  <p>• 900 • • 1600 •</p> <p>7445</p> <p>Left</p>	<p><b>Cable grommet (Incl. milling of cable hole)</b></p> <p>3425 Cable grommet in black metal (240 mm x 120 mm) 87</p> <p>3426 Cable grommet in black metal (160 mm x 80 mm) 52</p> <p>7445 Cable routing with slit (only for table tops <u>without</u> a meeting arch) 165</p>
	<p><b>CPU-holder</b></p> <p>7482 Large CPU-holder (H 200-460 mm x W 60-190 mm) 48</p> <p>8009MIC Small CPU-holder (H 175-310 mm x W 30-100 mm) 48</p> <p>Available in white, alu or black.</p>
	<p><b>Cleaning products</b></p> <p>3414 Linoleum cleaner 1L 31</p> <p>3415 Laminate cleaner 1L 23</p> <p>3445 Sponge for surfaces 4</p>
	<p><b>Cable organizer</b></p> <p>7973 Cable organizer, 1450 mm 46</p>

## QUADRO DESKS



Made in Denmark

Table top available in :

- **Veneer** : ash, beech, cherry, maple, oak or walnut
- **Standard laminate (HPL)**: Opaque White, Montana Grey, Platinum Grey, Anthracite Grey, Slate Grey, Volcanic Black or Lindberg Oak
- **Nordic Nature (HPL)**
- **XP mat laminate**
- **Linoleum**

7 x lacquer on veneer and  
3 x lacquer on edges.

Handset :

- Fingertouch (standard)
- Up / down
- Memory with Bluetooth\*

\* Note surcharge see page 92.

### Quadro desks in general :

- 2 or 3 columns with sit-stand function in white, alu or black powder coated steel or polished chrome\*
- 3-stage columns
- Round LINAK columns (DL11 Piezo) Ø 70 mm
- Feet with adjustable shoes, L 750 mm
- 12 table top shapes in many sizes
- Table top in 23 mm MDF with bevelled edges and radius 20 on corners
- Choose between 4 different surfaces for the table tops
- Rail-free construction
- Integrated cabel tray
- PVC free
- PIEZO technology (collision aviodence)
- CE-marked and EN 527-1\_2\_3 certified
- Height adjustment 640-1280 mm
- Low noise motor
- Lifts approx. 80 kg per column
- 100% made in Denmark
- 5 years warranty

Powered by  
**LINAK**

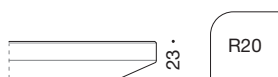

**PIEZO**  
HYDROELECTRIC TECHNOLOGY

**5**  
ans garanti

**PVC**  
FREE

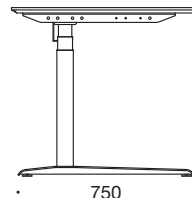

750

# QUADRO Desks

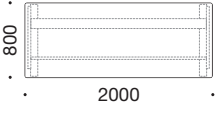
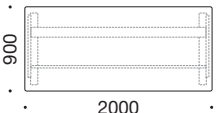
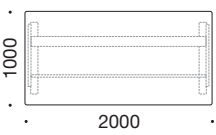
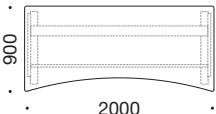
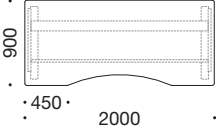
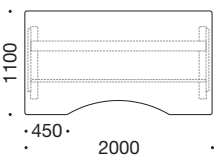
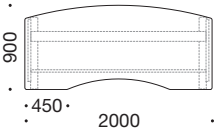

**Price**

	<p><b>Rectangular</b></p> <p>5720 2000 x 800 mm            5718 1800 x 800 mm            5716 1600 x 800 mm            5714 1400 x 800 mm            5712 1200 x 800 mm            5710 1000 x 800 mm</p>	<p><b>Surface and material</b></p> <p>HPL, veneer, Nordic Nature (HPL) 1.476            Linoleum or XP mat laminate 1.623</p> <p>Note, pen trays 7497 and 7496 cannot be mounted at desks with D 800 mm.</p>
	<p><b>Rectangular</b></p> <p>5740 2000 x 900 mm            5738 1800 x 900 mm            5736 1600 x 900 mm            5734 1400 x 900 mm            5732 1200 x 900 mm</p>	<p><b>Surface and material</b></p> <p>HPL, veneer, Nordic Nature (HPL) 1.476            Linoleum or XP mat laminate 1.623</p>
	<p><b>Rectangular</b></p> <p>5730 2000 x 1000 mm            5728 1800 x 1000 mm            5726 1600 x 1000 mm            5724 1400 x 1000 mm            5722 1200 x 1000 mm</p>	<p><b>Surface and material</b></p> <p>HPL, veneer, Nordic Nature (HPL) 1.476            Linoleum or XP mat laminate 1.623</p>
 <p>Whole arch D 150 mm</p>	<p><b>Whole arch</b></p> <p>5810 2000 x 900 mm            5808 1800 x 900 mm            5806 1600 x 900 mm            5804 1400 x 900 mm            5802 1200 x 900 mm</p>	<p><b>Surface and material</b></p> <p>HPL, veneer, Nordic Nature (HPL) 1.476            Linoleum or XP mat laminate 1.623</p>
 <p>Stomach arch D 120 mm</p>	<p><b>Stomach arch</b></p> <p>5820 2000 x 900 mm            5818 1800 x 900 mm            5816 1600 x 900 mm            5814 1400 x 900 mm            5812 1200 x 900 mm</p>	<p><b>Surface and material</b></p> <p>HPL, veneer, Nordic Nature (HPL) 1.476            Linoleum or XP mat laminate 1.623</p>
 <p>Stomach arch D 150 mm</p>	<p><b>Stomach arch</b></p> <p>5830 2000 x 1100 mm            5828 1800 x 1100 mm            5826 1600 x 1100 mm            5824 1400 x 1100 mm            5822 1200 x 1100 mm</p>	<p><b>Surface and material</b></p> <p>HPL, veneer, Nordic Nature (HPL) 1.476            Linoleum or XP mat laminate 1.623</p>
 <p>Stomach arch D 120 mm</p>	<p><b>Stomach + meeting arch</b></p> <p>5920 2000 x 900 mm            5918 1800 x 900 mm            5916 1600 x 900 mm            5914 1400 x 900 mm            5912 1200 x 900 mm</p>	<p><b>Surface and material</b></p> <p>HPL, veneer, Nordic Nature (HPL) 1.476            Linoleum or XP mat laminate 1.623</p>

Prices in EURO

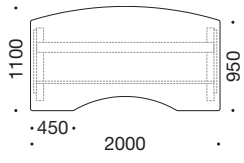
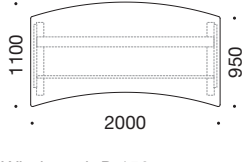
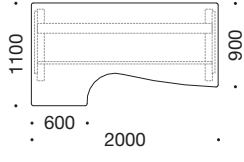
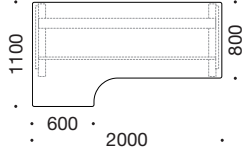
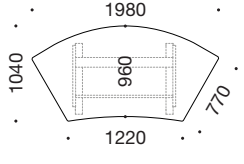
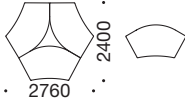
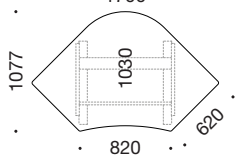
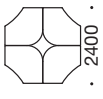
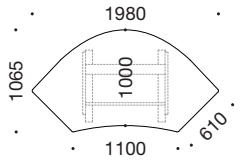

**QUADRO** Desks

Price

 <p>Stomach arch D 150 mm</p>	<p><b>Stomach + meeting arch</b></p> <p>5930 2000 x 1100 mm 5928 1800 x 1100 mm 5926 1600 x 1100 mm 5924 1400 x 1100 mm 5922 1200 x 1100 mm</p>	<p><b>Surface and material</b></p> <p>HPL, veneer, Nordic Nature (HPL) 1.476 Linoleum or XP mat laminate 1.623</p>
 <p>Whole arch D 150 mm</p>	<p><b>Whole + meeting arch</b></p> <p>5940 2000 x 1100 mm 5938 1800 x 1100 mm 5936 1600 x 1100 mm 5934 1400 x 1100 mm 5932 1200 x 1100 mm</p>	<p><b>Surface and material</b></p> <p>HPL, veneer, Nordic Nature (HPL) 1.476 Linoleum or XP mat laminate 1.623</p>
 <p>Stomach arch D 350 mm</p>	<p><b>Stomach arch D 350 mm</b></p> <p>5893 Left 2000 mm 5894 Right 2000 mm 5853 Left 1800 mm 5854 Right 1800 mm</p>	<p><b>Surface and material</b></p> <p>HPL, veneer, Nordic Nature (HPL) 1.476 Linoleum or XP mat laminate 1.623</p>
 <p>Stomach arch D 300 mm</p>	<p><b>Stomach arch D 300 mm</b></p> <p>5873 Left 2000 mm 5874 Right 2000 mm 5871 Left 1800 mm 5872 Right 1800 mm</p>	<p><b>Surface and material</b></p> <p>HPL, veneer, Nordic Nature (HPL) 1.476 Linoleum or XP mat laminate 1.623</p>
	<p><b>Cluster</b></p> <p>5906 Cluster desk, 1 pcs. Format for 3 persons</p> 	<p><b>Surface and material</b></p> <p>HPL, veneer, Nordic Nature (HPL) 1.476 Linoleum or XP mat laminate 1.623</p>
	<p><b>Cluster</b></p> <p>5905 Cluster desk, 1 pcs. Format for 4 persons</p> 	<p><b>Surface and material</b></p> <p>HPL, veneer, Nordic Nature (HPL) 1.476 Linoleum or XP mat laminate 1.623</p>
	<p><b>Cluster</b></p> <p>5907 Cluster desk, 1 pcs. Format for 4 persons</p> 	<p><b>Surface and material</b></p> <p>HPL, veneer, Nordic Nature (HPL) 1.476 Linoleum or XP mat laminate 1.623</p>

# QUADRO Desks

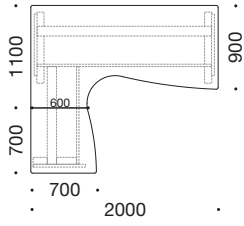
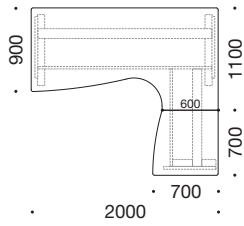
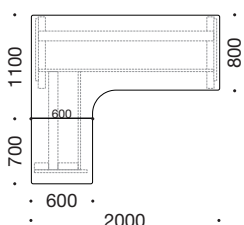
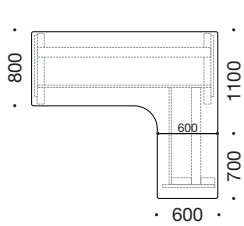
**Price**

	<p><b>Terminal A</b></p> <p>5895 Left 2000 mm 5855 Left 1800 mm Stomach arch D 350 mm</p>	<p><b>Surface and material</b></p> <p>HPL, veneer, Nordic Nature (HPL) 2.382 Linoleum or XP mat laminate 2.618</p>
	<p><b>Terminal A</b></p> <p>5896 Right 2000 mm 5856 Right 1800 mm Stomach arch D 350 mm</p>	<p><b>Surface and material</b></p> <p>HPL, veneer, Nordic Nature (HPL) 2.382 Linoleum or XP mat laminate 2.618</p>
	<p><b>Terminal B</b></p> <p>5883 Left 2000 mm 5881 Left 1800 mm Stomach arch D 300 mm</p>	<p><b>Surface and material</b></p> <p>HPL, veneer, Nordic Nature (HPL) 2.382 Linoleum or XP mat laminate 2.618</p>
	<p><b>Terminal B</b></p> <p>5884 Right 2000 mm 5882 Right 1800 mm Stomach arch D 300 mm</p>	<p><b>Surface and material</b></p> <p>HPL, veneer, Nordic Nature (HPL) 2.382 Linoleum or XP mat laminate 2.618</p>
	<p><b>Surcharge</b></p> <p>3407 Set of castors (not for 3 columns), set of 4 psc. 90 3405 Chrome legs per set (frame and cable tray in black, white or alu) 302 3406 Chrome foot per set (frame and cable tray in black, white or alu) 201 3410 Customized table top 84 7483 Milling cable hole in table top (<u>only</u> hole) 8 3260 Linoleum/HPL/XP over wooden edge, rectangular table top 108 3264 Linoleum/HPL/XP over wooden edge, table top with arch 215 3287 Fenix laminate up to 1200 mm (surcharge to the linoleum price) 90 3297 Fenix laminate, 1201-2200 mm (surcharge to the linoleum price) 136 3277 Fenix laminate, 2201-3000 mm (surcharge to the linoleum price) 181 3273 ABS/veneer on curved edge up to 2200 mm 139 3274 ABS/veneer on curved edge from 2201-2800 mm 223</p>	
	<p><b>Modesty screen / curtain</b></p> <p>5945 Modesty screen for desk length 2000 mm (1630 mm x 390 mm) 182 5946 Modesty screen for desk length 1800 mm (1430 mm x 390 mm) 182 5947 Modesty screen for desk length 1600 mm (1230 mm x 390 mm) 182 5948 Modesty screen for desk length 1400 mm (1030 mm x 390 mm) 182 5949 Modesty screen for desk length 1200 mm ( 830 mm x 390 mm) 182</p>	

Prices in EURO



# QUADRO Accessories



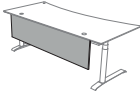
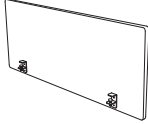
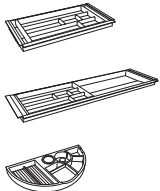
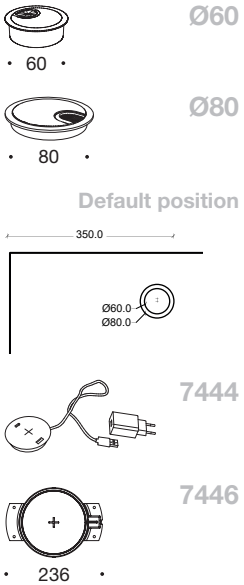



**Price**

	<p><b>Front panel in 16 mm plates</b></p> <table border="0"> <tr> <td>7470</td> <td>Panel for desk length 2000 mm (1630 mm x 400 mm)</td> <td>160</td> </tr> <tr> <td>7469</td> <td>Panel for desk length 2000 mm (1630 mm x 250 mm)</td> <td>144</td> </tr> <tr> <td>7468</td> <td>Panel for desk length 1800 mm (1430 mm x 400 mm)</td> <td>160</td> </tr> <tr> <td>7467</td> <td>Panel for desk length 1800 mm (1430 mm x 250 mm)</td> <td>128</td> </tr> <tr> <td>7466</td> <td>Panel for desk length 1600 mm (1230 mm x 400 mm)</td> <td>144</td> </tr> <tr> <td>7465</td> <td>Panel for desk length 1600 mm (1230 mm x 250 mm)</td> <td>111</td> </tr> </table> <p>Front panel available in all cabinet colors, both laminate and veneer.</p>	7470	Panel for desk length 2000 mm (1630 mm x 400 mm)	160	7469	Panel for desk length 2000 mm (1630 mm x 250 mm)	144	7468	Panel for desk length 1800 mm (1430 mm x 400 mm)	160	7467	Panel for desk length 1800 mm (1430 mm x 250 mm)	128	7466	Panel for desk length 1600 mm (1230 mm x 400 mm)	144	7465	Panel for desk length 1600 mm (1230 mm x 250 mm)	111												
7470	Panel for desk length 2000 mm (1630 mm x 400 mm)	160																													
7469	Panel for desk length 2000 mm (1630 mm x 250 mm)	144																													
7468	Panel for desk length 1800 mm (1430 mm x 400 mm)	160																													
7467	Panel for desk length 1800 mm (1430 mm x 250 mm)	128																													
7466	Panel for desk length 1600 mm (1230 mm x 400 mm)	144																													
7465	Panel for desk length 1600 mm (1230 mm x 250 mm)	111																													
	<p><b>Desk screen wall, D 30 mm</b></p> <table border="0"> <tr> <td>5956</td> <td>Desk screen wall incl. fittings, 800 x 550 mm</td> <td>260</td> </tr> <tr> <td>5955</td> <td>Desk screen wall incl. fittings, 1000 x 550 mm</td> <td>284</td> </tr> <tr> <td>5954</td> <td>Desk screen wall incl. fittings, 1200 x 550 mm</td> <td>289</td> </tr> <tr> <td>5953</td> <td>Desk screen wall incl. fittings, 1400 x 550 mm</td> <td>317</td> </tr> <tr> <td>5952</td> <td>Desk screen wall incl. fittings, 1600 x 550 mm</td> <td>334</td> </tr> <tr> <td>5951</td> <td>Desk screen wall incl. fittings, 1800 x 550 mm</td> <td>350</td> </tr> </table> <p><b>Acoustic desk screen with 20 mm mineral wool (A class), D 45 mm</b></p> <table border="0"> <tr> <td>5953A</td> <td>Acoustic desk screen wall incl. fittings, 1400 x 550 mm</td> <td>587</td> </tr> <tr> <td>5952A</td> <td>Acoustic desk screen wall incl. fittings, 1600 x 550 mm</td> <td>619</td> </tr> <tr> <td>5951A</td> <td>Acoustic desk screen wall incl. fittings, 1800 x 550 mm</td> <td>652</td> </tr> </table> <p>Upholstered with Cura (Gabriel): grey (60110) / slate grey (60019) / black (60999) <b>or</b> Hush (Gabriel): grey (60158) / black (60900).</p> <p><b>Surcharge</b></p> <table border="0"> <tr> <td>5950</td> <td>Choice of other color (screen walls)</td> <td>28</td> </tr> </table>	5956	Desk screen wall incl. fittings, 800 x 550 mm	260	5955	Desk screen wall incl. fittings, 1000 x 550 mm	284	5954	Desk screen wall incl. fittings, 1200 x 550 mm	289	5953	Desk screen wall incl. fittings, 1400 x 550 mm	317	5952	Desk screen wall incl. fittings, 1600 x 550 mm	334	5951	Desk screen wall incl. fittings, 1800 x 550 mm	350	5953A	Acoustic desk screen wall incl. fittings, 1400 x 550 mm	587	5952A	Acoustic desk screen wall incl. fittings, 1600 x 550 mm	619	5951A	Acoustic desk screen wall incl. fittings, 1800 x 550 mm	652	5950	Choice of other color (screen walls)	28
5956	Desk screen wall incl. fittings, 800 x 550 mm	260																													
5955	Desk screen wall incl. fittings, 1000 x 550 mm	284																													
5954	Desk screen wall incl. fittings, 1200 x 550 mm	289																													
5953	Desk screen wall incl. fittings, 1400 x 550 mm	317																													
5952	Desk screen wall incl. fittings, 1600 x 550 mm	334																													
5951	Desk screen wall incl. fittings, 1800 x 550 mm	350																													
5953A	Acoustic desk screen wall incl. fittings, 1400 x 550 mm	587																													
5952A	Acoustic desk screen wall incl. fittings, 1600 x 550 mm	619																													
5951A	Acoustic desk screen wall incl. fittings, 1800 x 550 mm	652																													
5950	Choice of other color (screen walls)	28																													
 <p>7497</p> <p>7496</p> <p>7495</p>	<p><b>Black metal pen tray with pull-out, lock and plastic tray</b></p> <table border="0"> <tr> <td>7497</td> <td>Pen tray, L 475 mm (H 40 mm x L 475 mm x D 270 mm)</td> <td>88</td> </tr> <tr> <td>7496</td> <td>Pen tray, L 850 mm (H 40 mm x L 850 mm x D 270 mm)</td> <td>111</td> </tr> </table> <p><b>Plastic pen tray</b></p> <table border="0"> <tr> <td>7495</td> <td>Plastic pen tray with pull-out (H 32 mm x L 350 mm x D 175 mm)</td> <td>38</td> </tr> </table> <p>All pen trays can be retrofitted.</p>	7497	Pen tray, L 475 mm (H 40 mm x L 475 mm x D 270 mm)	88	7496	Pen tray, L 850 mm (H 40 mm x L 850 mm x D 270 mm)	111	7495	Plastic pen tray with pull-out (H 32 mm x L 350 mm x D 175 mm)	38																					
7497	Pen tray, L 475 mm (H 40 mm x L 475 mm x D 270 mm)	88																													
7496	Pen tray, L 850 mm (H 40 mm x L 850 mm x D 270 mm)	111																													
7495	Plastic pen tray with pull-out (H 32 mm x L 350 mm x D 175 mm)	38																													
 <p>Ø60</p> <p>• 60 •</p> <p>Ø80</p> <p>• 80 •</p> <p>Default position</p> <p>350.0</p> <p>115.0</p> <p>Ø60.0</p> <p>Ø80.0</p> <p>7444</p> <p>7446</p> <p>193</p> <p>• 236 •</p>	<p><b>Cable grommets (Incl. milling of cable hole)</b></p> <table border="0"> <tr> <td>7479</td> <td>Cable grommets Ø 60 mm, white plastic</td> <td>13</td> </tr> <tr> <td>7480</td> <td>Cable grommets Ø 60 mm, black plastic</td> <td>13</td> </tr> <tr> <td>7481</td> <td>Cable grommets Ø 60 mm, alu</td> <td>28</td> </tr> <tr> <td>7488</td> <td>Cable grommets Ø 60 mm, polished chrome</td> <td>28</td> </tr> <tr> <td>7478</td> <td>Cable grommets Ø 60 mm, black metal</td> <td>28</td> </tr> </table> <p><b>Cable grommets (Incl. milling of cable hole)</b></p> <table border="0"> <tr> <td>7440</td> <td>Cable grommets Ø 80 mm, alu</td> <td>28</td> </tr> <tr> <td>7442</td> <td>Cable grommets Ø 80 mm, black plastic</td> <td>13</td> </tr> <tr> <td>7443</td> <td>Cable grommets Ø 80 mm, white plastic</td> <td>13</td> </tr> </table> <p><b>Wireless charger</b></p> <table border="0"> <tr> <td>7444</td> <td>Wireless charger with Qi technology. USB-A and USB-C outlet incl. EU power adapter, 15W fast charger (Incl. milling of a Ø 60 mm cable hole)</td> <td>55</td> </tr> <tr> <td>7446</td> <td>Invisible wireless charger which can charge through a desk (30 mm)</td> <td>62</td> </tr> </table>	7479	Cable grommets Ø 60 mm, white plastic	13	7480	Cable grommets Ø 60 mm, black plastic	13	7481	Cable grommets Ø 60 mm, alu	28	7488	Cable grommets Ø 60 mm, polished chrome	28	7478	Cable grommets Ø 60 mm, black metal	28	7440	Cable grommets Ø 80 mm, alu	28	7442	Cable grommets Ø 80 mm, black plastic	13	7443	Cable grommets Ø 80 mm, white plastic	13	7444	Wireless charger with Qi technology. USB-A and USB-C outlet incl. EU power adapter, 15W fast charger (Incl. milling of a Ø 60 mm cable hole)	55	7446	Invisible wireless charger which can charge through a desk (30 mm)	62
7479	Cable grommets Ø 60 mm, white plastic	13																													
7480	Cable grommets Ø 60 mm, black plastic	13																													
7481	Cable grommets Ø 60 mm, alu	28																													
7488	Cable grommets Ø 60 mm, polished chrome	28																													
7478	Cable grommets Ø 60 mm, black metal	28																													
7440	Cable grommets Ø 80 mm, alu	28																													
7442	Cable grommets Ø 80 mm, black plastic	13																													
7443	Cable grommets Ø 80 mm, white plastic	13																													
7444	Wireless charger with Qi technology. USB-A and USB-C outlet incl. EU power adapter, 15W fast charger (Incl. milling of a Ø 60 mm cable hole)	55																													
7446	Invisible wireless charger which can charge through a desk (30 mm)	62																													

Prices in EURO

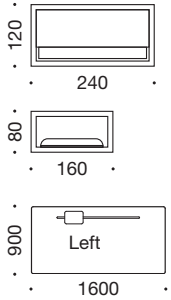
# QUADRO Desks

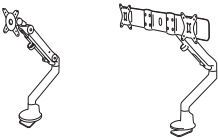
Price

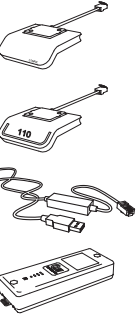
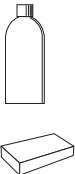
 <p>7447</p> <p>• 80 •</p>	<p><b>Cube multi connector (Incl. milling of cable hole)</b></p> <p>7447 Cube multi connector (Ø 80 mm), black plastic 85</p> <p>1 schuko power outlet, 16A 230V max 3500W</p> <p>1 wireless charger (Qi charger)</p> <p>1 RJ45 outlet</p> <p>1 USB-A outlet (DC5V, 2.4A) + 1 USB-C outlet for charging</p>
	<p><b>Powerstrip with alu case</b></p> <p>7500 Powerstrip incl. 6 x schuko plugs, USB-A, USB-C for charging 79</p>
 <p>120</p> <p>240</p> <p>80</p> <p>160</p> <p>900</p> <p>Left</p> <p>1600</p> <p>3425</p> <p>3426</p> <p>7445</p>	<p><b>Cable grommet (Incl. milling of cable hole)</b></p> <p>3425 Cable grommet in black metal (240 mm x 120 mm) 87</p> <p>3426 Cable grommet in black metal (160 mm x 80 mm) 52</p> <p>7445 Cable routing with slit (only for table tops <u>without</u> a meeting arch) 165</p>
	<p><b>CPU-holder</b></p> <p>7482 Large CPU-holder (H 200-460 mm x W 60-190 mm) 48</p> <p>8009MIC Small CPU-holder (H 175-310 mm x W 30-100 mm) 48</p> <p>Available in white, alu or black.</p>
 <p>7980</p> <p>7981</p>	<p><b>Monitor arm</b></p> <p>7980 Monitor arm in black metal (Max load 13 kg) 223</p> <p>7981 Dual monitor arm with crossbar (Max 6 kg per screen) 303</p> <p>Please specify if you want us to pre-drill a mounting hole in the table top.</p>
	<p><b>Cable organizer</b></p> <p>7973 Cable organizer, 1450 mm 46</p>
 <p>7988</p> <p>7989</p> <p>7487</p> <p>7986</p> <p>7987</p> <p>7986</p>	<p><b>LINAK accessories</b></p> <p>7988 Simple control, up / down (intuitive adjustment), anti-collision 32</p> <p>7989 Control DPi1C with auto-drive, anti-collision, display (Bluetooth) and up to 4 memory positions 79</p> <p>7487 Cable for the computer for Linak Desk Control, 2 m 63</p> <p>7986 LINAK battery (can be charged through external control box) 248</p> <p>7987 LINAK charger for battery <b>DISCONTINUED</b> 48</p> <p>5707 Surcharge: 80 mm/s high speed control panel 42</p>
	<p><b>Cleaning products</b></p> <p>3414 Linoleum cleaner 1L 31</p> <p>3415 Laminate cleaner 1L 23</p> <p>3445 Sponge for surfaces 4</p>

Prices in EURO

## S20 CHAIRS



### Variations :

- Conference chair with castors - with or without armrests
- Chair with runners - with / without armrests
- Chair with 4-legs - with / without armrests
- Bar stool - without armrests
- Lounge chair - without armrests

### Armrests :

- Black
- Polished alu

### Frame without castors :

- Black
- Polished steel

### Frame with castors :

- Black
- Polished alu

Seat and back are fully upholstered and available in:

Cura, Gabriel  
Mirage, Pugi-rg  
Main Line Flax, Camira  
Autumn, Kvadrat  
Fame, Gabriel  
Synergy, Camira  
Crisp, Gabriel  
Remix 3, Kvadrat  
Sport, Kvadrat  
Floyd Screen, Kvadrat  
Remix Screen, Kvadrat  
Capture, Gabriel  
Breeze Fusion, Gabriel  
Hero 2, Kvadrat  
Sydney læder, CAMO  
Dunes, Sørensen Læder  
Silk, CAMO

If you want upholstery in other Kvadrat variants, please contact Cube Design for prices.

### S20 chairs in general :

- 5 different fully upholstered chairs
  - Frame in polished alu / steel or black
  - Chairs with legs and runners are stackable
  - 17 different fabrics and leathers
- Material used per. chair 1,6 m textile / 2 m<sup>2</sup> leather  
Material used per bar stool 1,0 m textile / 1 m<sup>2</sup> leather  
Material used per lounge chair 2 m textile / 2,6 m<sup>2</sup> leather
- 6-8 weeks delivery time on chairs
  - 5 years warranty

The S20 chair can be upholstered in custom fabric. 1,6 m per chair  
- please contact Cube Design for prices.

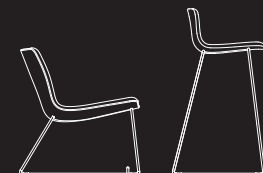

## S20 Chairs

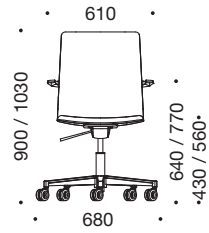
**Price**

**Conference chair with high back, armrests, tiltfunction, castors and height adjustment**
**Armrests and frame : black or polished alu**

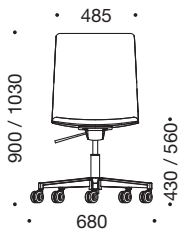
9853	Price gr. 1, Cura* (Gabriel), Mirage (Pugi-rg)	781
	Price gr. 2, Main Line Flax (Camira)	869
	Price gr. 3, Step Melange (Gabriel)	866
	Price gr. 4, Fame (Gabriel), Synergy (Camira), Autumn (Kvadrat)	890
	Price gr. 5, Crisp / Capture (Gabriel), Floyd / Remix Screen / Remix / Sport (Kvadrat)	902
	Price gr. 6, Breeze Fusion (Gabriel), Hero (Kvadrat)	918
	Price gr. 7, Sydney Leather (CAMO)	942
	Price gr. 8, Dunes (Soerensen Leather)** / Silk (CAMO)	1.145

**Conference chair with high back, tiltfunction, castors and height adjustment**
**Frame : black or polished alu**

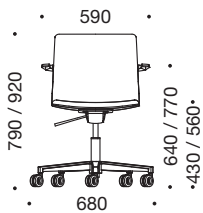
9851	Price gr. 1, Cura* (Gabriel), Mirage (Pugi-rg)	731
	Price gr. 2, Main Line Flax (Camira)	820
	Price gr. 3, Step Melange (Gabriel)	816
	Price gr. 4, Fame (Gabriel), Synergy (Camira), Autumn (Kvadrat)	839
	Price gr. 5, Crisp / Capture (Gabriel), Floyd / Remix Screen / Remix / Sport (Kvadrat)	853
	Price gr. 6, Breeze Fusion (Gabriel), Hero (Kvadrat)	868
	Price gr. 7, Sydney Leather (CAMO)	892
	Price gr. 8, Dunes (Soerensen Leather)** / Silk (CAMO)	1.095

**Conference chair with low back, armrests, tiltfunction, castors and height adjustment**
**Armrests and frame : black or polished alu**

9857	Price gr. 1, Cura* (Gabriel), Mirage (Pugi-rg)	731
	Price gr. 2, Main Line Flax (Camira)	820
	Price gr. 3, Step Melange (Gabriel)	816
	Price gr. 4, Fame (Gabriel), Synergy (Camira), Autumn (Kvadrat)	838
	Price gr. 5, Crisp / Capture (Gabriel), Floyd / Remix Screen / Remix / Sport (Kvadrat)	852
	Price gr. 6, Breeze Fusion (Gabriel), Hero (Kvadrat)	867
	Price gr. 7, Sydney Leather (CAMO)	890
	Price gr. 8, Dunes (Soerensen Leather)** / Silk (CAMO)	1.094

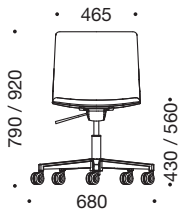
**Conference chair with low back, tiltfunction, castors and height adjustment**
**Frame : black or polished alu**

9855	Price gr. 1, Cura* (Gabriel), Mirage (Pugi-rg)	681
	Price gr. 2, Main Line Flax (Camira)	770
	Price gr. 3, Step Melange (Gabriel)	767
	Price gr. 4, Fame (Gabriel), Synergy (Camira), Autumn (Kvadrat)	788
	Price gr. 5, Crisp / Capture (Gabriel), Floyd / Remix Screen / Remix / Sport (Kvadrat)	802
	Price gr. 6, Breeze Fusion (Gabriel), Hero (Kvadrat)	818
	Price gr. 7, Sydney Leather (CAMO)	839
	Price gr. 8, Dunes (Soerensen Leather)** / Silk (CAMO)	1.044

**Accessories**

9774	Gliders in black plastic with details in polished chrome, 5 pcs.	48
9776	High gas lift, 1 pcs.	120

\* See the color chart in the back.

\*\* Unit price when buying minimum 4 chairs.

## S20 Chairs

**Price**

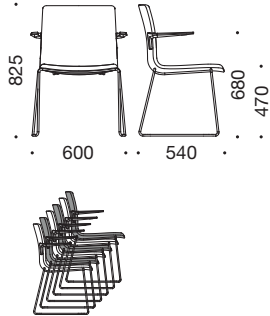
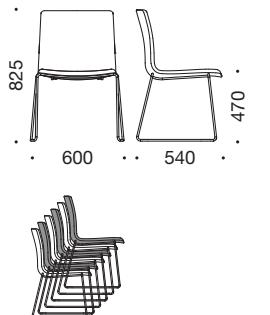
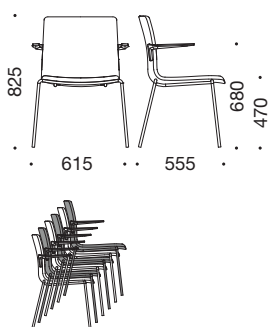
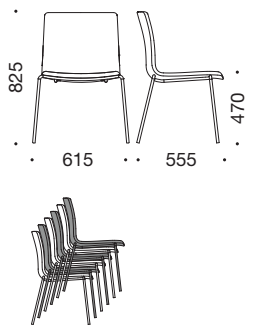
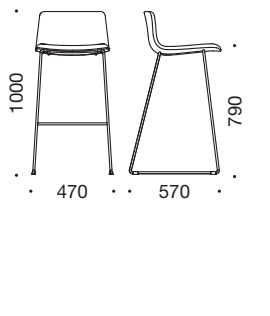
	<p><b>Chair with runners and armrests, black or polished frame</b></p> <p>9863    Price gr. 1, Cura* (Gabriel), Mirage (Pugi-rg) <span style="float: right;">619</span>            Price gr. 2, Main Line Flax (Camira) <span style="float: right;">708</span>            Price gr. 3, Step Melange (Gabriel) <span style="float: right;">704</span>            Price gr. 4, Fame (Gabriel), Synergy (Camira), Autumn (Kvadrat) <span style="float: right;">727</span>            Price gr. 5, Crisp / Capture (Gabriel), Floyd / Remix Screen / Remix / Sport (Kvadrat) <span style="float: right;">741</span>            Price gr. 6, Breeze Fusion (Gabriel), Hero (Kvadrat) <span style="float: right;">756</span>            Price gr. 7, Sydney Leather (CAMO) <span style="float: right;">779</span>            Price gr. 8, Dunes (Soerensen Leather)** / Silk (CAMO) <span style="float: right;">983</span></p>
	<p><b>Chair with runners, black or polished frame</b></p> <p>9861    Price gr. 1, Cura* (Gabriel), Mirage (Pugi-rg) <span style="float: right;">482</span>            Price gr. 2, Main Line Flax (Camira) <span style="float: right;">570</span>            Price gr. 3, Step Melange (Gabriel) <span style="float: right;">566</span>            Price gr. 4, Fame (Gabriel), Synergy (Camira), Autumn (Kvadrat) <span style="float: right;">590</span>            Price gr. 5, Crisp / Capture (Gabriel), Floyd / Remix Screen / Remix / Sport (Kvadrat) <span style="float: right;">603</span>            Price gr. 6, Breeze Fusion (Gabriel), Hero (Kvadrat) <span style="float: right;">619</span>            Price gr. 7, Sydney Leather (CAMO) <span style="float: right;">641</span>            Price gr. 8, Dunes (Soerensen Leather)** / Silk (CAMO) <span style="float: right;">845</span></p>
	<p><b>Chair with 4-legs and armrests, black or polished frame</b></p> <p>9867    Price gr. 1, Cura* (Gabriel), Mirage (Pugi-rg) <span style="float: right;">619</span>            Price gr. 2, Main Line Flax (Camira) <span style="float: right;">708</span>            Price gr. 3, Step Melange (Gabriel) <span style="float: right;">704</span>            Price gr. 4, Fame (Gabriel), Synergy (Camira), Autumn (Kvadrat) <span style="float: right;">727</span>            Price gr. 5, Crisp / Capture (Gabriel), Floyd / Remix Screen / Remix / Sport (Kvadrat) <span style="float: right;">741</span>            Price gr. 6, Breeze Fusion (Gabriel), Hero (Kvadrat) <span style="float: right;">756</span>            Price gr. 7, Sydney Leather (CAMO) <span style="float: right;">779</span>            Price gr. 8, Dunes (Soerensen Leather)** / Silk (CAMO) <span style="float: right;">983</span></p>
	<p><b>Chair with 4-legs, black or polished frame</b></p> <p>9865    Price gr. 1, Cura* (Gabriel), Mirage (Pugi-rg) <span style="float: right;">482</span>            Price gr. 2, Main Line Flax (Camira) <span style="float: right;">570</span>            Price gr. 3, Step Melange (Gabriel) <span style="float: right;">566</span>            Price gr. 4, Fame (Gabriel), Synergy (Camira), Autumn (Kvadrat) <span style="float: right;">590</span>            Price gr. 5, Crisp / Capture (Gabriel), Floyd / Remix Screen / Remix / Sport (Kvadrat) <span style="float: right;">603</span>            Price gr. 6, Breeze Fusion (Gabriel), Hero (Kvadrat) <span style="float: right;">619</span>            Price gr. 7, Sydney Leather (CAMO) <span style="float: right;">641</span>            Price gr. 8, Dunes (Soerensen Leather)** / Silk (CAMO) <span style="float: right;">845</span></p>
	<p><b>Bar stool, black frame</b></p> <p>9871    Price gr. 1, Cura* (Gabriel), Mirage (Pugi-rg) <span style="float: right;">396</span>            Price gr. 2, Main Line Flax (Camira) <span style="float: right;">477</span>            Price gr. 3, Step Melange (Gabriel) <span style="float: right;">475</span>            Price gr. 4, Fame (Gabriel), Synergy (Camira), Autumn (Kvadrat) <span style="float: right;">494</span>            Price gr. 5, Crisp / Capture (Gabriel), Floyd / Remix Screen / Remix / Sport (Kvadrat) <span style="float: right;">507</span>            Price gr. 6, Breeze Fusion (Gabriel), Hero (Kvadrat) <span style="float: right;">521</span>            Price gr. 7, Sydney Leather (CAMO) <span style="float: right;">542</span>            Price gr. 8, Dunes (Soerensen Leather)** / Silk (CAMO) <span style="float: right;">693</span></p>

\* See the color chart in the back.

\*\* Unit price when buying minimum 4 chairs.

Prices in EURO

## S20 Chairs

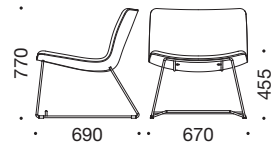
**Price**

**Lounge chair, black frame**

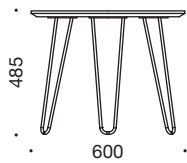
9881	Price gr. 1, Cura* (Gabriel), Mirage (Pugi-rg)	681
	Price gr. 2, Main Line Flax (Camira)	770
	Price gr. 3, Step Melange (Gabriel)	767
	Price gr. 4, Fame (Gabriel), Synergy (Camira), Autumn (Kvadrat)	789
	Price gr. 5, Crisp / Capture (Gabriel), Floyd / Remix Screen / Remix / Sport (Kvadrat)	803
	Price gr. 6, Breeze Fusion (Gabriel), Hero (Kvadrat)	819
	Price gr. 7, Sydney Leather (CAMO)	841
	Price gr. 8, Dunes (Soerensen Leather)** / Silk (CAMO)	1.044

**S20 lounge table with bevelled edge, H 485 mm**

		HPL, Veneer Nordic Nature	Linoleum XP laminate
9891	Lounge table Ø 500 mm	287	373
9892	Lounge table Ø 600 mm	287	373
9893	Lounge table Ø 700 mm	295	380

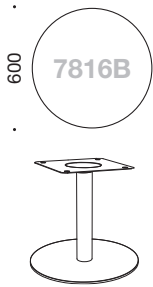
Black frame.

**Round table top with bevelled edge, 23 mm**

7816B	Round plate with bevelled edge, Ø 600 mm	183	269
7817B	Round plate with bevelled edge, Ø 700 mm	191	277

**Column**

0506.0000	Column, Ø 550 mm x H 545 mm		281
0570	Surcharge for column and foot in alu or white		83

Price group	Supplier	Fabric	Material	Durability
Price gr. 1	Gabriel	Cura*	98% recycled polyester / 2% polyester	100.000 Martindale
	Pugi-rg	Mirage	100% Polyester	100.000 Martindale
Price gr. 2	Camira	Main Line Flax	70% Wool / 30% Linen	50.000 Martindale
Price gr. 3	Gabriel	Step Melange	100% Polyester	100.000 Martindale
Price gr. 4	Gabriel	Fame	95% Wool / 5% Polyamide	200.000 Martindale
	Camira	Synergy	95% Wool / 5% Polyamide	100.000 Martindale
	Kvadrat	Autumn	100% Recycled polyester	
Price gr. 5	Gabriel	Crisp	93% Wool / 7% Polyamide	200.000 Martindale
	Gabriel	Capture	85% Wool / 15% Polyamide	200.000 Martindale
	Kvadrat	Remix	90 % Wool, 10 % nylon	
	Kvadrat	Remix screen	90 % Wool, 10 % nylon	
	Kvadrat	Sport	100 % Ocean bound polyester	
Price gr. 6	Gabriel	Floyd Screen	50 % Polyester, 45 % ny uld, 5 % nylon	
		Breeze Fusion	88% Wool / 12% Polyamide	100.000 Martindale
Price gr. 7	CAMO	Sydney	100% Leather	
Price gr. 8	Soerensen Leather	Dunes	100% Leather	
	CAMO	Silk	100% Leather	

\* See the color chart in the back.

\*\* Unit price when buying minimum 4 chairs.



## S10 CHAIRS



### Variations :

- Chair with runners - without armrests
- Chair with 4-legs - without armrests
- Conference chair with castors with / without armrests
- Bar stool - without armrests

### Armrests\* :

- Polyurethane rubber

### Frame without castors :

- Polished chrome

### Frame with castors :

- Polished alu

Seat and back are fully upholstered and available in a wide range of durable fabrics and leather:

Cura, Gabriel

Mirage, Pugi-rg

Main Line Flax, Camira

Autumn, Kvadrat

Fame, Gabriel

Synergy, Camira

Crisp, Gabriel

Remix 3, Kvadrat

Sport, Kvadrat

Floyd Screen, Kvadrat

Remix Screen, Kvadrat

Capture, Gabriel

Breeze Fusion, Gabriel

Hero 2, Kvadrat

Sydney læder, CAMO

Dunes, Sørensen Læder

Silk, CAMO

### S10 chairs in general :

- 4 different fully upholstered chairs
- Frame in polished chrome
- Frame with castors in polished alu
- Chairs with legs and runners are stackable
- 17 different fabrics and leathers  
Material used per chair 1,2 m textile / 1,75 m<sup>2</sup> leather  
Material used per bar stool 1,0 m textile / 1,55 m<sup>2</sup> leather
- 6-8 weeks delivery time on chairs
- 5 years warranty

If you want upholstery in other Kvadrat variants, please contact Cube Design for prices.



# S10 Chairs

Price

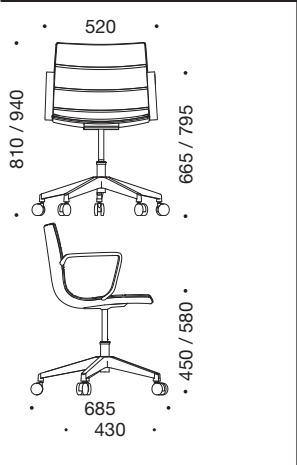
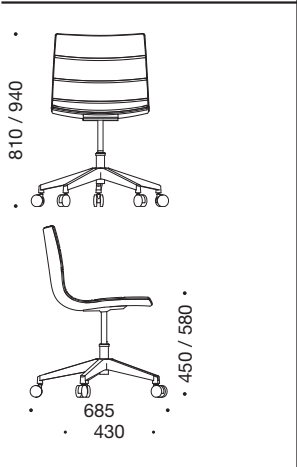
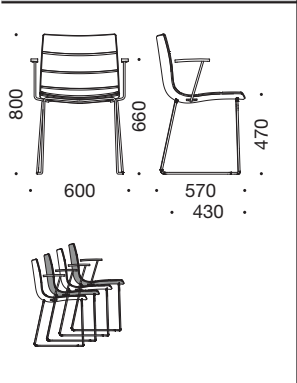
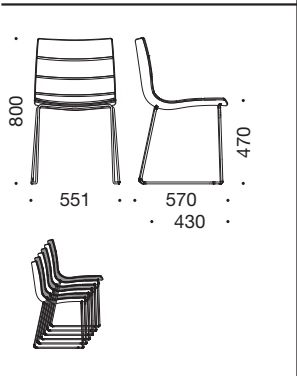
	<p><b>Conference chair with armrests, tilt function, castors and height adjustment</b></p> <p>9772 Price gr. 1, Cura* (Gabriel), Mirage (Pugi-rg) 715            Price gr. 2, Main Line Flax (Camira) 798            Price gr. 3, Step Melange (Gabriel) 795            Price gr. 4, Fame (Gabriel), Synergy (Camira), Autumn (Kvadrat) 818            Price gr. 5, Crisp / Capture (Gabriel), Floyd Screen / Remix Screen / Remix / Sport (Kvadrat) 831            Price gr. 6, Breeze Fusion (Gabriel), Hero (Kvadrat) 846            Price gr. 7, Sydney Leather (CAMO) 869            Price gr. 8, Dunes (Soerensen Leather)** / Silk (CAMO) 1.073</p>
	<p><b>Conference chair with tilt function, castors and height adjustment</b></p> <p>9768 Price gr. 1, Cura* (Gabriel), Mirage (Pugi-rg) 668            Price gr. 2, Main Line Flax (Camira) 750            Price gr. 3, Step Melange (Gabriel) 748            Price gr. 4, Fame (Gabriel), Synergy (Camira), Autumn (Kvadrat) 771            Price gr. 5, Crisp / Capture (Gabriel), Floyd Screen / Remix Screen / Remix / Sport (Kvadrat) 783            Price gr. 6, Breeze Fusion (Gabriel), Hero (Kvadrat) 799            Price gr. 7, Sydney Leather (CAMO) 822            Price gr. 8, Dunes (Soerensen Leather)** / Silk (CAMO) 1.026</p>
	<p><b>Accessories</b></p> <p>9773 Castors in polished chrome, 5 pcs. 63            9774 Gliders in black plastic with details in polished chrome, 5 pcs. 48            9776 High gas lift, 1 pcs. 120</p>
	<p><b>Chair with runners and armrests <del>DISCONTINUED</del></b></p> <p>9763 <del>Price-gr. 1, Cura* (Gabriel), Mirage (Pugi-rg)            Price-gr. 2, Main Line Flax (Camira)            Price-gr. 3, Step Melange (Gabriel)            Price-gr. 4, Fame (Gabriel), Synergy (Camira), Autumn (Kvadrat)            Price-gr. 5, Crisp / Capture (Gabriel), Floyd Screen / Remix Screen / Remix / Sport (Kvadrat)            Price-gr. 6, Breeze Fusion (Gabriel), Hero (Kvadrat)            Price-gr. 7, Sydney Leather (CAMO)            Price-gr. 8, Dunes (Soerensen Leather)** / Silk (CAMO)</del></p>
	<p><b>Chair with runners</b></p> <p>9761 Price gr. 1, Cura* (Gabriel), Mirage (Pugi-rg) 459            Price gr. 2, Main Line Flax (Camira) 531            Price gr. 3, Step Melange (Gabriel) 528            Price gr. 4, Fame (Gabriel), Synergy (Camira), Autumn (Kvadrat) 551            Price gr. 5, Crisp / Capture (Gabriel), Floyd Screen / Remix Screen / Remix / Sport (Kvadrat) 564            Price gr. 6, Breeze Fusion (Gabriel), Hero (Kvadrat) 580            Price gr. 7, Sydney Leather (CAMO) 550            Price gr. 8, Dunes (Soerensen Leather)** / Silk (CAMO) 806</p>

\* See the color chart in the back.

\*\* Unit price when buying minimum 4 chairs.



# S10 Chairs

Price

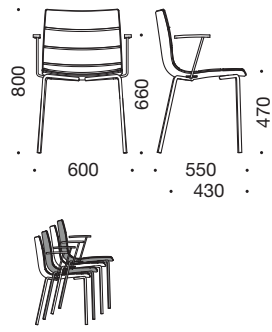

**Chair with 4-legs and armrests DISCONTINUED**

- 9767 — Price gr. 1, Cura\* (Gabriel), Mirage (Pugi-rg)  
 — Price gr. 2, Main Line Flax (Camira)  
 — Price gr. 3, Step Melange (Gabriel)  
 — Price gr. 4, Fame (Gabriel), Synergy (Camira), Autumn (Kvadrat)  
 — Price gr. 5, Crisp / Capture (Gabriel), Floyd Screen / Remix Screen / Remix / Sport (Kvadrat)  
 — Price gr. 6, Breeze Fusion (Gabriel), Hero (Kvadrat)  
 — Price gr. 7, Sydney Leather (CAMO)  
 — Price gr. 8, Dunes (Soerensen Leather)\*\* / Silk (CAMO)

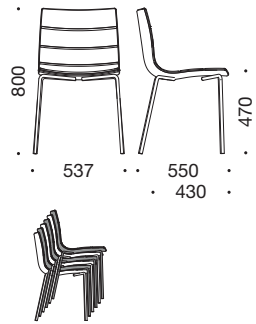

**Chair with 4-legs**

- 9765 Price gr. 1, Cura\* (Gabriel), Mirage (Pugi-rg) 459  
 Price gr. 2, Main Line Flax (Camira) 531  
 Price gr. 3, Step Melange (Gabriel) 528  
 Price gr. 4, Fame (Gabriel), Synergy (Camira), Autumn (Kvadrat) 551  
 Price gr. 5, Crisp / Capture (Gabriel), Floyd Screen / Remix Screen / Remix / Sport (Kvadrat) 564  
 Price gr. 6, Breeze Fusion (Gabriel), Hero (Kvadrat) 580  
 Price gr. 7, Sydney Leather (CAMO) 550  
 Price gr. 8, Dunes (Soerensen Leather)\*\* / Silk (CAMO) 806

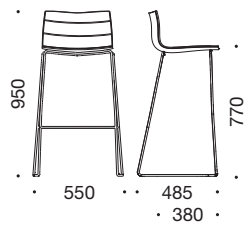

**Bar stool**

- 9771 Price gr. 1, Cura\* (Gabriel), Mirage (Pugi-rg) 381  
 Price gr. 2, Main Line Flax (Camira) 461  
 Price gr. 3, Step Melange (Gabriel) 458  
 Price gr. 4, Fame (Gabriel), Synergy (Camira), Autumn (Kvadrat) 480  
 Price gr. 5, Crisp / Capture (Gabriel), Floyd Screen / Remix Screen / Remix / Sport (Kvadrat) 491  
 Price gr. 6, Breeze Fusion (Gabriel), Hero (Kvadrat) 505  
 Price gr. 7, Sydney Leather (CAMO) 446  
 Price gr. 8, Dunes (Soerensen Leather)\*\* / Silk (CAMO) 680

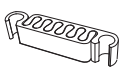

1 set

**Linking device for chairs - black plastic**

- 9792 Linking device for chairs, per set 16

**Surcharge**

- 3245 Legs / runners in black or white, per chair 36  
 3246 Swivel bases and armrests in black, per chair 75  
 3247 Felt shoes for chairs with runners, set of 4 pcs. 30

\* See the color chart in the back.

\*\* Unit price when buying minimum 4 chairs.

# S10 Chairs

Price group	Supplier	Fabric	Material	Durability
Price gr. 1	Gabriel	Cura*	98% recycled polyester / 2% polyester	100.000 Martindale
	Pugi-rg	Mirage	100% Polyester	100.000 Martindale
Price gr. 2	Camira	Main Line Flax	70% Wool / 30% Linen	50.000 Martindale
Price gr. 3	Gabriel	Step Melange	100% Polyester	100.000 Martindale
Price gr. 4	Gabriel	Fame	95% Wool / 5% Polyamide	200.000 Martindale
	Camira	Synergy	95% Wool / 5% Polyamide	100.000 Martindale
	Kvadrat	Autumn	100% Recycled polyester	
Price gr. 5	Gabriel	Crisp	93% Wool / 7% Polyamide	200.000 Martindale
	Gabriel	Capture	85% Wool / 15% Polyamide	200.000 Martindale
	Kvadrat	Remix	90 % Wool, 10 % nylon	
	Kvadrat	Remix screen	90 % Wool, 10 % nylon	
	Kvadrat	Sport	100 % Ocean bound polyester	
	Kvadrat	Floyd Screen	50 % Polyester, 45 % ny uld, 5 % nylon	
Price gr. 6	Gabriel	Breeze Fusion	88% Wool / 12% Polyamide	100.000 Martindale
Price gr. 7	CAMO	Sydney	100% Leather	
Price gr. 8	Soerensen Leather	Dunes	100% Leather	
	CAMO	Silk	100% Leather	

\* See the color chart in the back.

\*\* Unit price when bying minimum 4 chairs.

# VESPER CHAIRS



## Vesper chairs in general :

- 2 different chairs
- Shells in fiberglass (15%) polypropylene
- 6 shell colors
- Legs in chrome, white (galvanized) or black (galvanized)
- Stackable
- White and black frames can be used outdoors
- Upholstered seat available (surcharge)
- 5 years warranty

## Variations:

- Vesper 1: Chair
- Vesper 12: Bar stool

## Shell\* available in::

- Black
- Grey
- Sand
- White
- Pale blue
- Red

## The frame is available in:

- Chrome
- Galvanized and powder coated black\*\*
- Galvanized and powder coated in white\*\*



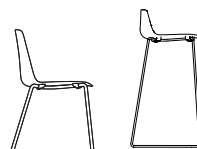

\* The colors are indicative. Please contact Cube Designs for color samples.

\*\* Only applies for Vesper 1 with four legs.

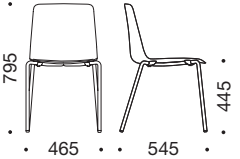

## VESPER Chairs

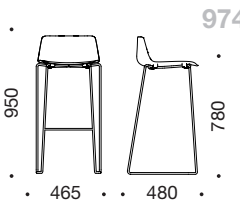
Price

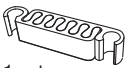
	<p><b>Vesper 1</b></p> <p>9757 Stackable chair without armrests Frame in chrome, white or black</p> <p>0601 Chair suspension for Vesper 1 chair, per set</p> 	<p>169</p> <p>60</p>
	<p><b>Vesper 12</b></p> <p>9745 Stackable bar stool with a low back Frame in chrome</p> 	<p>232</p>
	<p><b>Upholstered seat for Vesper 1 &amp; 12 chairs</b></p> <p>9752 Sand (Bondai 1005) Dark sand (Bondai 1008) Black (Bondai 8033) Red (Bondai 4011) Green (Bondai 7021)</p> <p>Upholstered seats can be upholstered in custom fabric. 0,5 m per chair.</p>	<p>44</p>
 <p>1 set</p>	<p><b>Linking device for chairs - black plastic</b></p> <p>9792 Linking device for chairs, per set</p>	<p>16</p>

### Technical information

	Supplier	Fabric	Material	Durability
Upholstered seat	FI.DI.VI	Bondai	100% Polyester	150.000 Martindale

## VERZO TABLES



Table top available in :

- **Veneer** : maple, ash, beech, oak, cherry or walnut
- **Standard laminate (HPL)**: Opaque White, Montana Grey, Platinum Grey, Anthracite Grey, Slate Grey, Volcanic Black or Lindberg Oak
- **Nordic Nature (HPL)**
- **XP mat laminate**
- **Linoleum**

7 x lacquer on veneer and  
3 x lacquer on edges

Straight edges :

- Veneered plates with straight edges are made with wooden edge.
- Laminate plates with straight edges are made with ABS-edges.

Legs :

- Black powder coated steel
- Solid oak

### Verzo tables in general :

- 2 versions : straight edge or bevelled edge with overhang
- Legs in black powder coated metal as well as solid oak
- The frame is always black
- Table top in 23 mm MDF with bevelled or straight edges
- Choose between 4 different surfaces for the table tops
- Rectangular table tops with bevelled edge and radius 4 on corners
- Rectangular table tops with straight edges and radius 2 on corners
- 5 years warranty



**VERZO** Straight edge

HPL, Veneer  
Nordic Nature

Linoleum  
XP laminate

HPL, Veneer  
Nordic Nature

Linoleum  
XP laminate

**Straight edge**

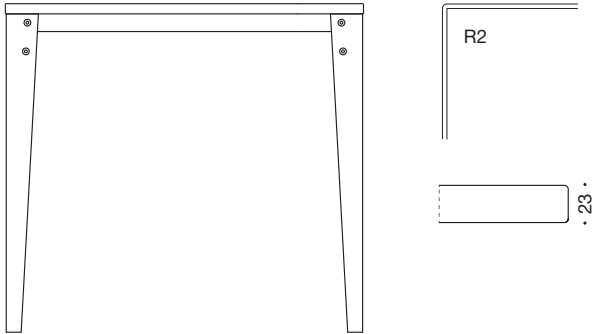

	<p><b>Verzo meeting table, D 814 mm</b></p>	<p>353080 3014 x 814 mm 352880 2814 x 814 mm 352480 2414 x 814 mm 352080 2014 x 814 mm 351880 1814 x 814 mm 351680 1614 x 814 mm</p>	<p>1.991 1.930 1.799 1.261 1.241 1.223</p>	<p>2.150 2.121 1.971 1.410 1.390 1.373</p>	<p>2.316 2.272 2.147 1.604 1.586 1.567</p>	<p>2.500 2.471 2.322 1.754 1.735 1.717</p>
	<p><b>Verzo meeting table, D 1014 mm</b></p>	<p>353010 3014 x 1014 mm 352810 2814 x 1014 mm 352410 2414 x 1014 mm 352010 2014 x 1014 mm 351810 1814 x 1014 mm 351610 1614 x 1014 mm</p>	<p>2.027 1.964 1.831 1.261 1.241 1.223</p>	<p>2.188 2.158 2.006 1.410 1.390 1.373</p>	<p>2.357 2.313 2.185 1.604 1.586 1.567</p>	<p>2.545 2.516 2.363 1.754 1.735 1.717</p>
	<p><b>Verzo meeting table, D 1214 mm</b></p>	<p>353012 3014 x 1214 mm 352812 2814 x 1214 mm 352412 2414 x 1214 mm 352012 2014 x 1214 mm 351812 1814 x 1214 mm 351612 1614 x 1214 mm</p>	<p>2.118 2.055 1.919 1.261 1.241 1.223</p>	<p>2.279 2.249 2.097 1.410 1.390 1.321</p>	<p>2.449 2.405 2.276 1.604 1.586 1.567</p>	<p>2.639 2.609 2.457 1.754 1.735 1.717</p>
	<p><b>Verzo meeting table, square</b></p>	<p>352020 2014 x 2014 mm (2-piece) 351818 1814 x 1814 mm (2-piece) 351616 1614 x 1614 mm (2-piece) 351010 1014 x 1014 mm</p>	<p>1.534 1.447 1.497 1.197</p>	<p>1.836 1.758 1.756 1.276</p>	<p>1.877 1.791 1.841 1.541</p>	<p>2.179 2.101 2.099 1.620</p>

Prices in EURO

HPL : Table top in standard laminate (HPL) in Opaque White, Montana Grey, Platinum Grey, Anthracite Grey, Slate Grey, Volcanic Black or Lindberg Oak. Incl. assembly fittings 9126 for 2- and 3-piece table tops.

**VERZO** Bevelled edge

HPL, Veneer  
Nordic Nature

Linoleum  
XP laminate

HPL, Veneer  
Nordic Nature

Linoleum  
XP laminate

**Bevelled edge**

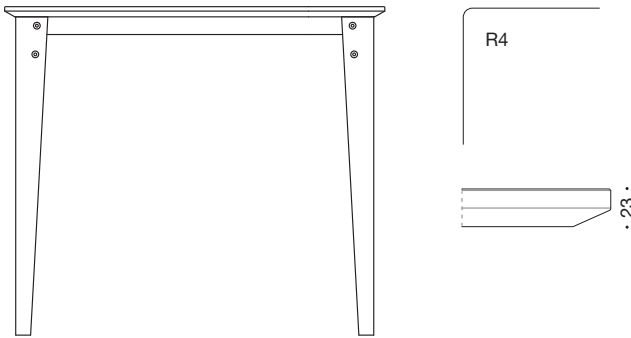

	<p><b>Verzo meeting table, D 864 mm</b></p> <table border="1"> <tbody> <tr> <td>352881</td> <td>2864 x 864 mm</td> <td>1.930</td> <td>2.121</td> <td>2.272</td> <td>2.471</td> </tr> <tr> <td>352481</td> <td>2464 x 864 mm</td> <td>1.799</td> <td>1.971</td> <td>2.147</td> <td>2.322</td> </tr> <tr> <td>352081</td> <td>2064 x 864 mm</td> <td>1.261</td> <td>1.410</td> <td>1.604</td> <td>1.754</td> </tr> <tr> <td>351881</td> <td>1864 x 864 mm</td> <td>1.241</td> <td>1.390</td> <td>1.586</td> <td>1.735</td> </tr> <tr> <td>351681</td> <td>1664 x 864 mm</td> <td>1.223</td> <td>1.373</td> <td>1.567</td> <td>1.717</td> </tr> </tbody> </table>	352881	2864 x 864 mm	1.930	2.121	2.272	2.471	352481	2464 x 864 mm	1.799	1.971	2.147	2.322	352081	2064 x 864 mm	1.261	1.410	1.604	1.754	351881	1864 x 864 mm	1.241	1.390	1.586	1.735	351681	1664 x 864 mm	1.223	1.373	1.567	1.717
352881	2864 x 864 mm	1.930	2.121	2.272	2.471																										
352481	2464 x 864 mm	1.799	1.971	2.147	2.322																										
352081	2064 x 864 mm	1.261	1.410	1.604	1.754																										
351881	1864 x 864 mm	1.241	1.390	1.586	1.735																										
351681	1664 x 864 mm	1.223	1.373	1.567	1.717																										
	<p><b>Verzo meeting table, D 1064 mm</b></p> <table border="1"> <tbody> <tr> <td>352811</td> <td>2864 x 1064 mm</td> <td>1.964</td> <td>2.158</td> <td>2.313</td> <td>2.516</td> </tr> <tr> <td>352411</td> <td>2464 x 1064 mm</td> <td>1.831</td> <td>2.006</td> <td>2.185</td> <td>2.363</td> </tr> <tr> <td>352011</td> <td>2064 x 1064 mm</td> <td>1.261</td> <td>1.410</td> <td>1.604</td> <td>1.754</td> </tr> <tr> <td>351811</td> <td>1864 x 1064 mm</td> <td>1.241</td> <td>1.390</td> <td>1.586</td> <td>1.735</td> </tr> <tr> <td>351611</td> <td>1664 x 1064 mm</td> <td>1.223</td> <td>1.373</td> <td>1.567</td> <td>1.717</td> </tr> </tbody> </table>	352811	2864 x 1064 mm	1.964	2.158	2.313	2.516	352411	2464 x 1064 mm	1.831	2.006	2.185	2.363	352011	2064 x 1064 mm	1.261	1.410	1.604	1.754	351811	1864 x 1064 mm	1.241	1.390	1.586	1.735	351611	1664 x 1064 mm	1.223	1.373	1.567	1.717
352811	2864 x 1064 mm	1.964	2.158	2.313	2.516																										
352411	2464 x 1064 mm	1.831	2.006	2.185	2.363																										
352011	2064 x 1064 mm	1.261	1.410	1.604	1.754																										
351811	1864 x 1064 mm	1.241	1.390	1.586	1.735																										
351611	1664 x 1064 mm	1.223	1.373	1.567	1.717																										
	<p><b>Verzo meeting table, square</b></p> <table border="1"> <tbody> <tr> <td>352021</td> <td>2064 x 2064 mm (2-piece)</td> <td>1.534</td> <td>1.836</td> <td>1.877</td> <td>2.179</td> </tr> <tr> <td>351819</td> <td>1864 x 1864 mm (2-piece)</td> <td>1.447</td> <td>1.758</td> <td>1.791</td> <td>2.101</td> </tr> <tr> <td>351617</td> <td>1664 x 1664 mm (2-piece)</td> <td>1.497</td> <td>1.756</td> <td>1.841</td> <td>2.099</td> </tr> <tr> <td>351011</td> <td>1064 x 1064 mm</td> <td>1.197</td> <td>1.276</td> <td>1.541</td> <td>1.620</td> </tr> </tbody> </table>	352021	2064 x 2064 mm (2-piece)	1.534	1.836	1.877	2.179	351819	1864 x 1864 mm (2-piece)	1.447	1.758	1.791	2.101	351617	1664 x 1664 mm (2-piece)	1.497	1.756	1.841	2.099	351011	1064 x 1064 mm	1.197	1.276	1.541	1.620						
352021	2064 x 2064 mm (2-piece)	1.534	1.836	1.877	2.179																										
351819	1864 x 1864 mm (2-piece)	1.447	1.758	1.791	2.101																										
351617	1664 x 1664 mm (2-piece)	1.497	1.756	1.841	2.099																										
351011	1064 x 1064 mm	1.197	1.276	1.541	1.620																										
	<p style="text-align: right;"><b>Price</b></p> <p><b>Surcharge</b></p> <table border="1"> <tbody> <tr> <td>3260</td> <td>Linoleum/HPL/XP over wooden edge, up to 2200 mm</td> <td>108</td> </tr> <tr> <td>3261</td> <td>Linoleum/HPL/XP over wooden edge, 2201 mm - 3000 mm</td> <td>204</td> </tr> <tr> <td>3429</td> <td>Wooden legs with Nordic Nature lacquer or walnut stain, 4 legs</td> <td>304</td> </tr> <tr> <td>3287</td> <td>Fenix laminate up to 1200 mm (surcharge to the linoleum price)</td> <td>90</td> </tr> <tr> <td>3297</td> <td>Fenix laminate, 1201-2200 mm (surcharge to the linoleum price)</td> <td>136</td> </tr> <tr> <td>3277</td> <td>Fenix laminate, 2201-3000 mm (surcharge to the linoleum price)</td> <td>181</td> </tr> </tbody> </table>	3260	Linoleum/HPL/XP over wooden edge, up to 2200 mm	108	3261	Linoleum/HPL/XP over wooden edge, 2201 mm - 3000 mm	204	3429	Wooden legs with Nordic Nature lacquer or walnut stain, 4 legs	304	3287	Fenix laminate up to 1200 mm (surcharge to the linoleum price)	90	3297	Fenix laminate, 1201-2200 mm (surcharge to the linoleum price)	136	3277	Fenix laminate, 2201-3000 mm (surcharge to the linoleum price)	181												
	3260	Linoleum/HPL/XP over wooden edge, up to 2200 mm	108																												
	3261	Linoleum/HPL/XP over wooden edge, 2201 mm - 3000 mm	204																												
	3429	Wooden legs with Nordic Nature lacquer or walnut stain, 4 legs	304																												
	3287	Fenix laminate up to 1200 mm (surcharge to the linoleum price)	90																												
	3297	Fenix laminate, 1201-2200 mm (surcharge to the linoleum price)	136																												
3277	Fenix laminate, 2201-3000 mm (surcharge to the linoleum price)	181																													

**VERZO** Straight edge

HPL, Veneer  
Nordic Nature

Linoleum  
XP laminate

HPL, Veneer  
Nordic Nature

Linoleum  
XP laminate

**Straight edge**



**Verzo conference table, L 3584 mm**

353512	3584 x 1214 mm (2-piece)	2.593	2.906	3.133	3.447
353510	3584 x 1014 mm (2-piece)	2.558	2.871	3.098	3.411
353580	3584 x 814 mm (2-piece)	2.524	2.838	3.064	3.378



**Verzo conference table, L 4184 mm**

354112	4184 x 1214 mm (2-piece)	2.806	3.119	3.345	3.658
354110	4184 x 1014 mm (2-piece)	2.775	3.088	3.315	3.628
354180	4184 x 814 mm (2-piece)	2.745	3.058	3.284	3.597



**Verzo conference table, L 4784 mm**

354712	4784 x 1214 mm (2-piece)	2.993	3.306	3.532	3.846
354710	4784 x 1014 mm (2-piece)	2.937	3.250	3.477	3.790
354780	4784 x 814 mm (2-piece)	2.881	3.195	3.421	3.735



**Verzo conference table, L 5456 mm**

355412	5456 x 1214 mm (3-piece)	3.217	3.686	3.935	4.404
355410	5456 x 1014 mm (3-piece)	3.135	3.605	3.854	4.325
355480	5456 x 814 mm (3-piece)	3.063	3.541	3.772	4.243



**Verzo conference table, L 6056 mm**

356012	6056 x 1214 mm (3-piece)	3.333	3.802	4.052	4.522
356010	6056 x 1014 mm (3-piece)	3.242	3.712	3.962	4.432
356080	6056 x 814 mm (3-piece)	2.972	3.622	3.872	4.341

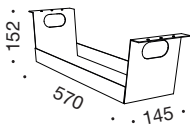

**Cable tray for meeting table**

3424	Cable tray in black metal				79
------	---------------------------	--	--	--	----



**Powerstrip with alu case**

7500	Powerstrip incl. 6 x schuko plugs, USB-A, USB-C for charging				79
------	--	--	--	--	----

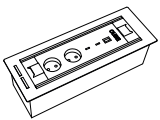

**Black connecting box (Incl. milling of cable hole)**

7501	Electrical rotatable connecting box (milled into the table top), black metal				350
	H 103 mm x L 340 mm x W 122 mm (hole 323 mm x 104 mm)				
	Connectivity : 2 x 220V (Schuko), 2 x USB-C charging, HDMI 2.0 (4K, 60 HZ)				

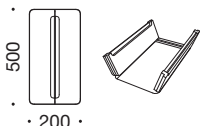

**Cable grommet (Incl. milling of cable hole)**

3427	Cable grommet with brushes				419
	Available in laminate, veneer, linoleum or XP mat laminate				

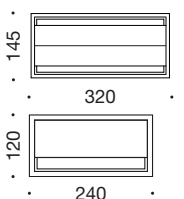

3417

3425

**Cable grommet (Incl. milling of cable hole)**

3417	Cable grommet in black metal with brushes and cover (320 mm x 145 mm)				121
3425	Cable grommet in black metal (240 mm x 120 mm)				87
3426	Cable grommet in black metal (160 mm x 80 mm)				52



**VERZO** Bevelled edge

HPL, Veneer  
Nordic Nature

Linoleum  
XP laminate

HPL, Veneer  
Nordic Nature

Linoleum  
XP laminate

**Bevelled edge**



**Verzo conference table, L 3634 mm**

353511	3634 x 1064 mm (2-piece)	2.558	2.871	3.098	3.411
353581	3634 x 864 mm (2-piece)	2.524	2.838	3.064	3.378



**Verzo conference table, L 4234 mm**

354111	4234 x 1064 mm (2-piece)	2.775	3.088	3.315	3.628
354181	4234 x 864 mm (2-piece)	2.745	3.058	3.284	3.597



**Verzo conference table, L 4834 mm**

354711	4834 x 1064 mm (2-piece)	2.937	3.250	3.477	3.790
354781	4834 x 864 mm (2-piece)	2.881	3.195	3.421	3.735



**Verzo conference table, L 5506 mm**

355411	5506 x 1064 mm (3-piece)	3.135	3.605	3.854	4.325
355481	5506 x 864 mm (3-piece)	3.063	3.541	3.772	4.243



**Verzo conference table, L 6106 mm**

356011	6106 x 1064 mm (3-piece)	3.242	3.712	3.962	4.432
356081	6106 x 864 mm (3-piece)	2.972	3.622	3.872	4.341

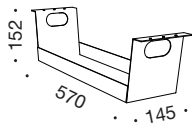

**Cable tray for meeting table**

3424	Cable tray in black metal				79
------	---------------------------	--	--	--	----



**Powerstrip with alu case**

7500	Powerstrip incl. 6 x schuko plugs, USB-A, USB-C for charging				79
------	--	--	--	--	----

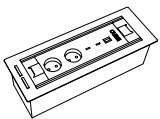

**Black connecting box (Incl. milling of cable hole)**

7501	Electrical rotatable connecting box (milled into the table top), black metal				350
	H 103 mm x L 340 mm x W 122 mm (hole 323 mm x 104 mm)				
	Connectivity : 2 x 220V (Schuko), 2 x USB-C charging, HDMI 2.0 (4K, 60 HZ)				

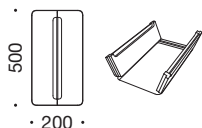

**Cable grommet (Incl. milling of cable hole)**

3427	Cable grommet with brushes				419
	Available in laminate, veneer, linoleum or XP mat laminate				

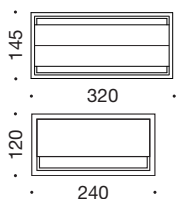

**3417**

**3425**

**Cable grommet (Incl. milling of cable hole)**

3417	Cable grommet in black metal with brushes and cover (320 mm x 145 mm)				121
3425	Cable grommet in black metal (240 mm x 120 mm)				87
3426	Cable grommet in black metal (160 mm x 80 mm)				52

# VERZO Overview

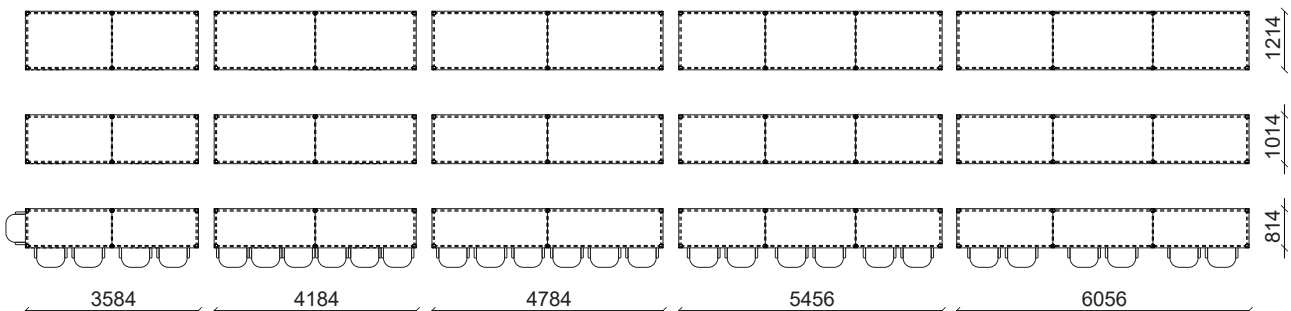
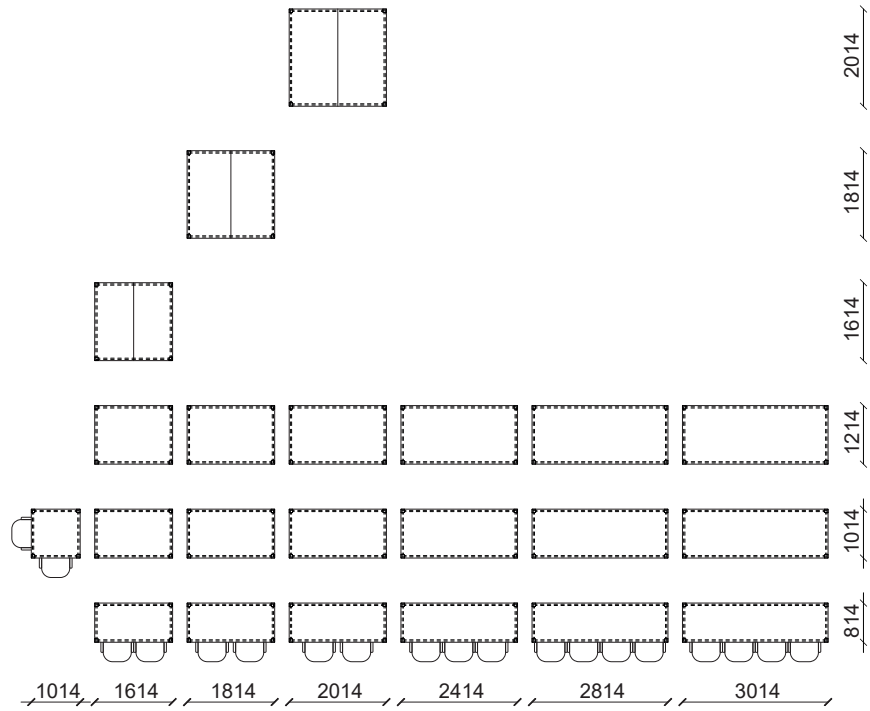
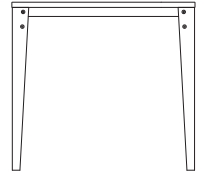

## SPIDER TABLES



Table top available in :

- **Veneer** : maple, ash, beech, oak, cherry or walnut
- **Standard laminate (HPL)**: Opaque White, Montana Grey, Platinum Grey, Anthracite Grey, Slate Grey, Volcanic Black or Lindberg Oak
- **Nordic Nature (HPL)**
- **XP mat laminate**
- **Linoleum**

7 x lacquer on veneer and  
3 x lacquer on edges

Straight edges\* :

- Veneered plates with straight edges are made with wooden edge.
- Laminate plates with straight edges are made with ABS-edges.

Legs for table height 743 mm :

- White powder coated steel
- Black powder coated steel
- Solid oak

Legs for table height 923 mm :

- Black powder coated steel
- Solid oak

Legs for table height 1058 mm :

- Black powder coated steel
- Solid oak

\* Surcharge for straight edges on round table tops. See page 113.

### Spider tables in general :

- 3 heights : H 743 mm, H 923 mm and H 1058 mm
- Regular legs (H 743 mm) in white or black as well as solid oak
- Legs in H 923 mm and H 1058 mm in black
- The frame is always black
- Table top in 23 mm MDF with bevelled edges
- Choose between 4 different surfaces for the table tops
- Rectangular table tops with bevelled edge and radius 20 on corners
- Rectangular table tops with straight edges and radius 2 on corners
- Round table tops are made with bevelled edges\*
- The legs are placed to edge as a standard (A)
- It is possible to retract the legs on selected sizes (B)
- 5 years warranty



**SPIDER** Tables

HPL, Veneer  
Nordic Nature

Linoleum  
XP laminate

HPL, Veneer  
Nordic Nature

Linoleum  
XP laminate

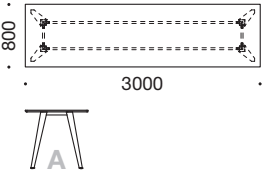
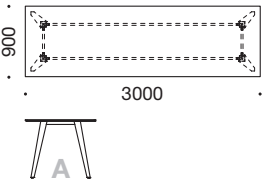
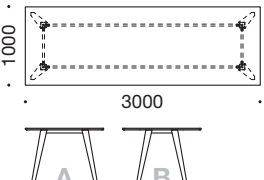
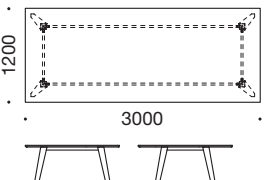
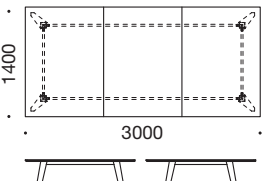
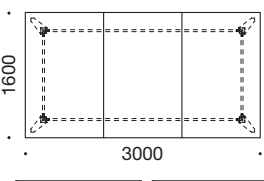
		HPL, Veneer Nordic Nature	Linoleum XP laminate	HPL, Veneer Nordic Nature	Linoleum XP laminate
	<b>Spider meeting table, H 743 mm</b>				
	343008 3000 x 800 mm	1.991	2.150	2.316	2.500
	342808 2800 x 800 mm	1.930	2.121	2.272	2.471
	342408 2400 x 800 mm	1.799	1.971	2.147	2.322
	342008 2000 x 800 mm	1.261	1.410	1.604	1.754
	341808 1800 x 800 mm	1.241	1.390	1.586	1.735
341608 1600 x 800 mm	1.223	1.373	1.567	1.717	
	<b>Spider meeting table, H 743 mm</b>				
	343009 3000 x 900 mm	2.009	2.169	2.337	2.522
	342809 2800 x 900 mm	1.947	2.140	2.292	2.493
	342409 2400 x 900 mm	1.814	1.989	2.166	2.342
	342009 2000 x 900 mm	1.261	1.410	1.604	1.754
	341809 1800 x 900 mm	1.241	1.390	1.586	1.735
341609 1600 x 900 mm	1.223	1.373	1.567	1.717	
	<b>Spider meeting table, H 743 mm</b>				
	343010 3000 x 1000 mm	2.027	2.188	2.358	2.545
	342810 2800 x 1000 mm	1.965	2.159	2.312	2.515
	342410 2400 x 1000 mm	1.831	2.006	2.185	2.363
	342010 2000 x 1000 mm	1.261	1.410	1.604	1.754
	341810 1800 x 1000 mm	1.241	1.390	1.586	1.735
341610 1600 x 1000 mm	1.223	1.373	1.567	1.717	
	<b>Spider meeting table, H 743 mm</b>				
	343012 3000 x 1200 mm	2.118	2.279	2.449	2.639
	342812 2800 x 1200 mm	2.055	2.249	2.405	2.609
	342412 2400 x 1200 mm	1.919	2.097	2.276	2.457
	342012 2000 x 1200 mm	1.261	1.410	1.604	1.754
	341812 1800 x 1200 mm	1.241	1.390	1.586	1.735
341612 1600 x 1200 mm	1.223	1.321	1.567	1.717	
	<b>Spider meeting table, H 743 mm</b>				
	343014 3000 x 1400 mm (3-piece)	2.248	2.444	2.608	2.804
342814 2800 x 1400 mm (3-piece)	2.212	2.408	2.573	2.767	
	<b>Spider meeting table, H 743 mm</b>				
	343016 3000 x 1600 mm (3-piece)	2.321	2.517	2.680	2.876
342816 2800 x 1600 mm (3-piece)	2.285	2.480	2.644	2.839	

Prices in EURO

HPL : Table top in standard laminate (HPL) in Opaque White, Montana Grey, Platinum Grey, Anthracite Grey, Slate Grey, Volcanic Black or Lindberg Oak. Incl. assembly fittings 9126 for 3-piece table tops.

# SPIDER Tables

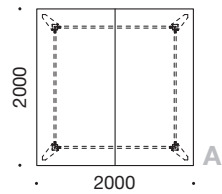
**HPL, Veneer  
Nordic Nature**
**Linoleum  
XP laminate**
**HPL, Veneer  
Nordic Nature**
**Linoleum  
XP laminate**

**Spider meeting table, H 743 mm, square**

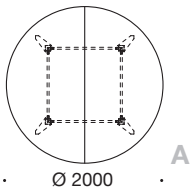
342020	2000 x 2000 mm (2-piece)	1.534	1.836	1.877	2.179
341818	1800 x 1800 mm (2-piece)	1.447	1.758	1.791	2.101
341616	1600 x 1600 mm (2-piece)	1.497	1.756	1.841	2.099
341010	1000 x 1000 mm	1.197	1.276	1.541	1.620

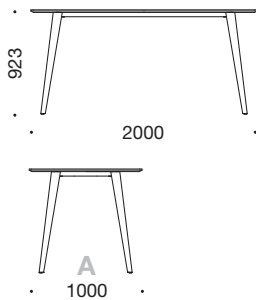

**Spider meeting table, H 743 mm, round**

3439	Ø 2000 mm (2-piece)	1.761	1.911	2.105	2.255
3438	Ø 1800 mm (2-piece)	1.715	1.866	2.059	2.210
3437	Ø 1600 mm (2-piece)	1.671	1.821	2.014	2.164
3436	Ø 1400 mm (2-piece)	1.617	1.767	1.960	2.111
3435	Ø 1200 mm	1.166	1.256	1.495	1.583
3434	Ø 1000 mm	1.133	1.222	1.461	1.550

**Spider table, H 923 mm**

3470	2000 x 1000 mm	1.296	1.450	1.640	1.793
3471	1600 x 1000 mm	1.259	1.411	1.603	1.755
3472	1000 x 1000 mm	1.222	1.317	1.565	1.660
3475	Ø 1200 mm	1.202	1.292	1.530	1.621
3474	Ø 1000 mm	1.166	1.257	1.494	1.584

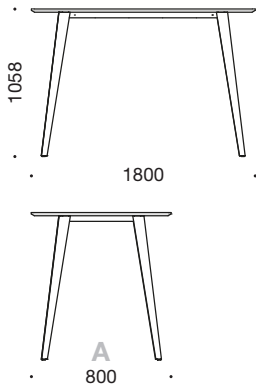
This Spider frame is available in black.

**Spider table, H 1058 mm**

3463	1800 x 800 mm	1.333	1.487	1.677	1.831
3462	1600 x 800 mm	1.296	1.450	1.640	1.793
3461	1200 x 800 mm	1.259	1.354	1.603	1.698
3460	800 x 800 mm	1.222	1.317	1.565	1.660
3465	Ø 1200 mm	1.202	1.292	1.530	1.621
3464	Ø 1000 mm	1.166	1.257	1.494	1.584

This Spider frame is available in black.

**Surcharge**

		<b>Price</b>
3275	Straight ABS or wooden edges on round table tops	124
3410	Customized table top	84
3260	Linoleum/HPL/XP over wooden edge, up to 2200 mm	108
3261	Linoleum/HPL/XP over wooden edge, 2201 mm - 3000 mm	204
3414	Linoleum cleaner 1L	31
3415	Laminate cleaner 1L	23
3445	Sponge for surfaces	4
3429	Wooden legs with Nordic Nature lacquer or walnut stain, 4 legs	304
3287	Fenix laminate up to 1200 mm (surcharge to the linoleum price)	90
3297	Fenix laminate, 1201-2200 mm (surcharge to the linoleum price)	136
3277	Fenix laminate, 2201-3000 mm (surcharge to the linoleum price)	181

Prices in EURO

HPL : Table top in standard laminate (HPL) in Opaque White, Montana Grey, Platinum Grey, Anthracite Grey, Slate Grey, Volcanic Black or Lindberg Oak. Incl. assembly fittings 9126 for 2-, 3- and 4-piece table tops.

# SPIDER Tables

HPL, Veneer  
Nordic Nature

Linoleum  
XP laminate

HPL, Veneer  
Nordic Nature

Linoleum  
XP laminate

## Tables H 743 mm



### Spider conference table, L 3600 mm

3400.3616	3600 x 1600 mm (3-piece)	2.775	3.088	3.315	3.628
3400.3614	3600 x 1400 mm (3-piece)	2.738	3.052	3.278	3.592
3400.3612	3600 x 1200 mm (2-piece)	2.593	2.906	3.133	3.447
3400.3610	3600 x 1000 mm (2-piece)	2.558	2.871	3.098	3.411

The veneer direction on 3-piece tables is across the table - see page 116.

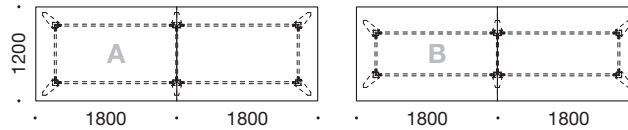

### Spider conference table, L 4200 mm

3400.4216	4200 x 1600 mm (4-piece)	3.097	3.410	3.637	3.950
3400.4214	4200 x 1400 mm (4-piece)	2.952	3.264	3.492	3.804
3400.4212	4200 x 1200 mm (2-piece)	2.806	3.119	3.345	3.658
3400.4210	4200 x 1000 mm (2-piece)	2.775	3.088	3.315	3.628

The veneer direction on 4-piece tables is across the table - see page 116.

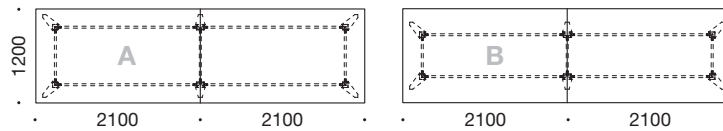

### Spider conference table, L 4800 mm

3400.4820	4800 x 2000 mm (4-piece)	3.575	3.888	4.114	4.428
3400.4818	4800 x 1800 mm (4-piece)	3.428	3.742	3.968	4.281
3400.4816	4800 x 1600 mm (4-piece)	3.283	3.597	3.823	4.136
3400.4814	4800 x 1400 mm (4-piece)	3.137	3.450	3.676	3.990
3400.4812	4800 x 1200 mm (2-piece)	2.993	3.306	3.532	3.846
3400.4810	4800 x 1000 mm (2-piece)	2.937	3.250	3.477	3.790

The veneer direction on 4-piece tables is across the table - see page 116.

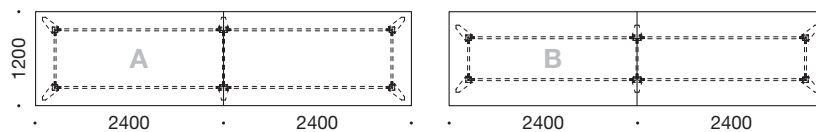

# SPIDER Tables

HPL, Veneer  
Nordic Nature

Linoleum  
XP laminate

HPL, Veneer  
Nordic Nature

Linoleum  
XP laminate



### Spider conference table, L 5400 mm

3400.5420	5400 x 2000 mm (5-piece)	3.800	4.270	4.519	4.989
3400.5418	5400 x 1800 mm (5-piece)	3.653	4.125	4.372	4.844
3400.5416	5400 x 1600 mm (5-piece)	3.508	3.967	4.227	4.686
3400.5414	5400 x 1400 mm (5-piece)	3.362	3.833	4.081	4.551
3400.5412	5400 x 1200 mm (3-piece)	3.217	3.686	3.935	4.404
3400.5410	5400 x 1000 mm (3-piece)	3.135	3.605	3.854	4.325

The veneer direction on 5-piece tables is across the table - see page 116.

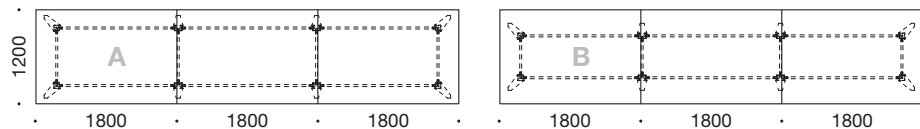

### Spider conference table, L 6000 mm

3400.6020	6000 x 2000 mm (5-piece)	3.916	4.386	4.636	5.105
3400.6018	6000 x 1800 mm (5-piece)	3.770	4.241	4.488	4.960
3400.6016	6000 x 1600 mm (5-piece)	3.624	4.095	4.342	4.814
3400.6014	6000 x 1400 mm (5-piece)	3.478	3.949	4.197	4.668
3400.6012	6000 x 1200 mm (3-piece)	3.333	3.802	4.052	4.522
3400.6010	6000 x 1000 mm (3-piece)	3.242	3.712	3.962	4.432

The veneer direction on 5-piece tables is across the table - see page 116.

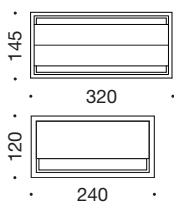
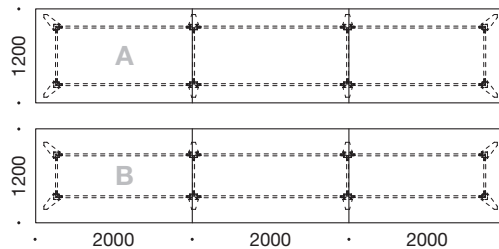

3417

3425

### Cable grommet (Incl. milling of cable hole)

3417	Cable grommet in black metal with brushes and cover (320 mm x 145 mm)	121
3425	Cable grommet in black metal (240 mm x 120 mm)	87
3426	Cable grommet in black metal (160 mm x 80 mm)	52

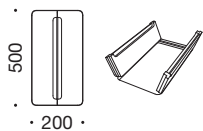

### Cable grommet (Incl. milling of cable hole)

3427	Cable grommet with brushes	419
------	----------------------------	-----

Available in laminate, veneer, linoleum or XP mat laminate

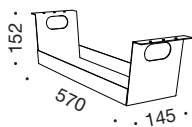

### Cable tray for meeting table

3424	Cable tray in black metal	79
------	---------------------------	----



### Powerstrip with alu case

7500	Powerstrip incl. 6 x schuko plugs, USB-A, USB-C for charging	79
------	--	----

Prices in EURO

HPL : Table top in standard laminate (HPL) in Opaque White, Montana Grey, Platinum Grey, Anthracite Grey, Slate Grey, Volcanic Black or Lindberg Oak. Incl. assembly fittings 9126 for 2-, 3-, 4- and 5-piece table tops.

# SPIDER Overview

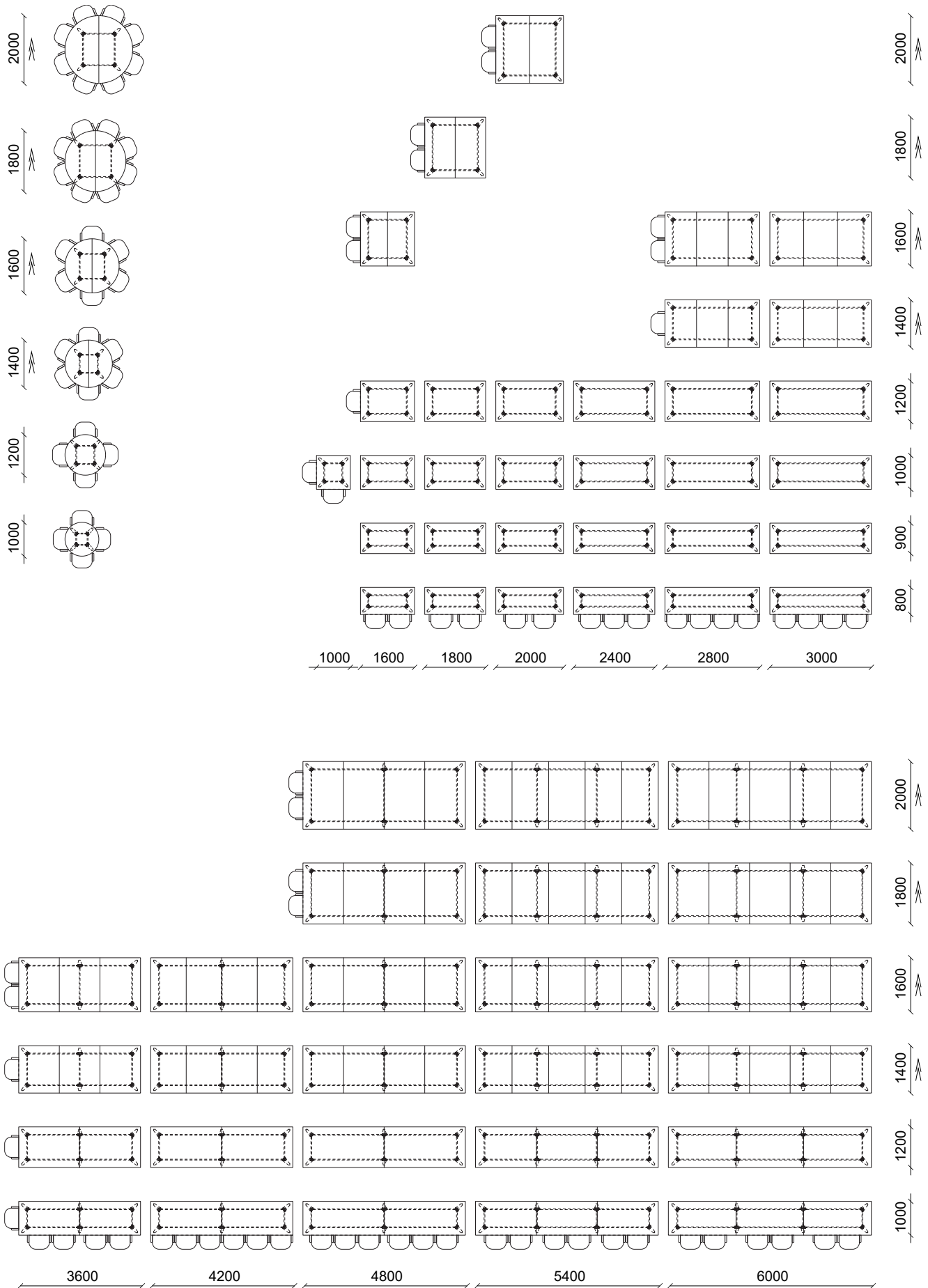



# MEETING / CONFERENCE TABLES



Table top available in :

- **Veneer** : maple, ash, beech, oak, cherry or walnut
- **Standard laminate (HPL)**: Opaque White, Montana Grey, Platinum Grey, Anthracite Grey, Slate Grey, Volcanic Black or Lindberg Oak
- **Nordic Nature (HPL)**
- **XP mat laminate**
- **Linoleum**

7 x lacquer on veneer and  
3 x lacquer on edges

Frame (steel) :

- Quadro
- Amigo

Quadro frame available in :

- White (powder coated)
- Alu / silver (powder coated)
- Black (powder coated)
- Polished chrome\*

Amigo frame available in :

- Brushed stainless steel
- Black (powder coated)
- Alu (powder coated)\*
- White (powder coated)\*

\* Note surcharge see page 122.

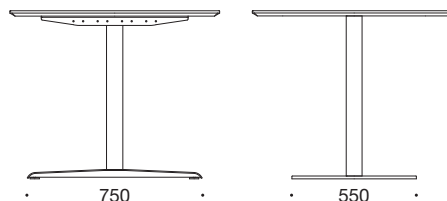
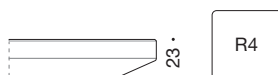

## Meeting / conference tables in general :

- 2 frames : Quadro (T-frame) or Amigo (columns Ø 90 mm)
- Height: Quadro T-frame H 720 mm, Amigo frame H 743 mm
- Quadro frame available with sit-stand function
- 8 standard table top shapes in many sizes
- Table top in 23 mm MDF with bevelled edges and radius 4 on corners
- Choose between 4 different surfaces for the table tops
- 5 years warranty

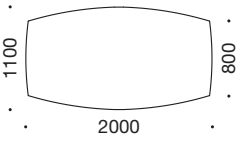
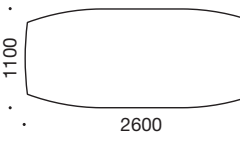
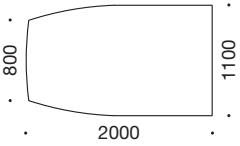
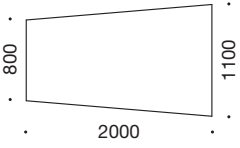

# MEETING

**HPL, Veneer  
Nordic Nature**
**Linoleum  
XP laminate**
**HPL, Veneer  
Nordic Nature**
**Linoleum  
XP laminate**

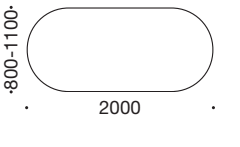
		HPL, Veneer Nordic Nature	Linoleum XP laminate	HPL, Veneer Nordic Nature	Linoleum XP laminate	
	<b>Barrel shaped meeting table</b>					
	3730	Barrel shaped, L 3000 mm	1.891	2.085	1.632*	1.826*
	3728	Barrel shaped, L 2800 mm	1.793	1.985	1.474*	1.667*
	3726	Barrel shaped, L 2600 mm	1.726	1.918	1.316	1.511
	3724	Barrel shaped, L 2400 mm	1.660	1.854	1.252	1.444
	3722	Barrel shaped, L 2200 mm	1.517	1.665	1.126	1.275
	3692	Barrel shaped, L 2000 mm	1.411	1.560	1.062	1.210
3690	Barrel shaped, L 1800 mm	1.411	1.560	1.062	1.210	
	<b>Boat shaped meeting table</b>					
	3740	Boat shaped, L 3000 mm	1.891	2.085	1.632*	1.826*
	3738	Boat shaped, L 2800 mm	1.793	1.985	1.474*	1.667*
	3736	Boat shaped, L 2600 mm	1.726	1.918	1.316	1.511
3734	Boat shaped, L 2400 mm	1.660	1.854	1.252	1.444	
	<b>Half boat shaped meeting table</b>					
	3720	Half boat shaped, L 3000 mm	1.891	2.085	1.632*	1.826*
	3718	Half boat shaped, L 2800 mm	1.793	1.985	1.474*	1.667*
	3716	Half boat shaped, L 2600 mm	1.726	1.918	1.316	1.511
	3714	Half boat shaped, L 2400 mm	1.660	1.854	1.252	1.444
	3712	Half boat shaped, L 2200 mm	1.586	1.740	1.177	1.332
	3696	Half boat shaped, L 2000 mm	1.411	1.560	1.062	1.210
3694	Half boat shaped, L 1800 mm	1.411	1.560	1.062	1.210	
	<b>Trapeze shaped meeting table</b>					
	3677	Trapeze shaped, L 3000 mm	1.891	2.085	1.632*	1.826*
	3676	Trapeze shaped, L 2800 mm	1.793	1.985	1.474*	1.667*
	3675	Trapeze shaped, L 2600 mm	1.726	1.918	1.316	1.511
	3674	Trapeze shaped, L 2400 mm	1.660	1.854	1.252	1.444
	3673	Trapeze shaped, L 2200 mm	1.586	1.740	1.177	1.332
	3672	Trapeze shaped, L 2000 mm	1.411	1.560	1.062	1.210
3671	Trapeze shaped, L 1800 mm	1.411	1.560	1.062	1.210	
	<b>Rectangular meeting table</b>					
	3630	Rectangular, L 3000 mm	1.891	2.085	1.632*	1.826*
	3628	Rectangular, L 2800 mm	1.793	1.985	1.474*	1.667*
	3626	Rectangular, L 2600 mm	1.726	1.918	1.316	1.511
	3624	Rectangular, L 2400 mm	1.660	1.854	1.252	1.444
	3622	Rectangular, L 2200 mm	1.586	1.740	1.177	1.332
	3620	Rectangular, L 2000 mm	1.411	1.560	1.062	1.210
	3618	Rectangular, L 1800 mm	1.411	1.560	1.062	1.210
	3616	Rectangular, L 1600 mm	1.234	1.382	1.062	1.210
	3614	Rectangular, L 1400 mm	1.178	1.320	1.013	1.155
3612	Rectangular, L 1200 mm	1.178	1.266	1.013	1.101	
	<b>Meeting table with half round ends</b>					
	3750	Half round ends, L 3000 mm	1.891	2.085	1.632*	1.826*
	3748	Half round ends, L 2800 mm	1.793	1.985	1.474*	1.667*
	3746	Half round ends, L 2600 mm	1.726	1.918	1.316	1.511
	3744	Half round ends, L 2400 mm	1.660	1.854	1.252	1.444
	3743	Half round ends, L 2200 mm	1.586	1.740	1.177	1.332
	3742	Half round ends, L 2000 mm	1.411	1.560	1.062	1.210
	3741	Half round ends, L 1800 mm	1.411	1.560	1.062	1.210

Prices in EURO

\* The table has three columns.

# MEETING

**HPL, Veneer  
Nordic Nature**
**Linoleum  
XP laminate**
**HPL, Veneer  
Nordic Nature**
**Linoleum  
XP laminate**

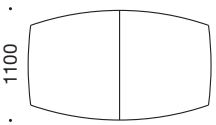
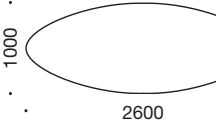
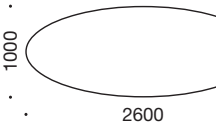
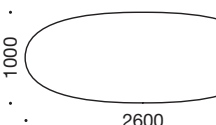
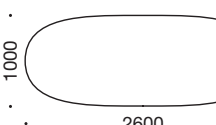
 <p>1100 2000</p>	<p><b>Meeting table with synchronos pull-out and storage for 2 additional leaves</b></p> <p>3680 Rectangular, L 2000 mm 2.063 2.212 - -</p> <p>3678 Rectangular, L 1850 mm 2.063 2.212 - -</p> <p><b>Additional leaf</b></p> <p>3388 Additional leaf, L 490 x D 1100 168 250</p>
 <p>1100 2000 800</p>	<p><b>Meeting table with synchronos pull-out and storage for 2 additional leaves</b></p> <p>3682 Barrel shaped, L 2000 mm 2.063 2.212 - -</p> <p>3686 Barrel shaped, L 1850 mm 2.063 2.212 - -</p> <p><b>Additional leaf</b></p> <p>3388 Additional leaf, L 490 x D 1100 168 250</p>
<b>Ellipse A, B, C, D</b>	<p><b>3255 Surcharge for changing ellipse meeting table 228</b></p>
 <p>1000 2600</p>	<p><b>Ellipse A meeting table</b></p> <p>3790 Ellipse A, L 3000 mm x D 1100 mm 1.891 2.085 1.632* 1.826*</p> <p>3788 Ellipse A, L 2800 mm x D 1100 mm 1.793 1.985 1.474* 1.667*</p> <p>3786 Ellipse A, L 2600 mm x D 1000 mm 1.726 1.918 1.316 1.511</p> <p>3784 Ellipse A, L 2400 mm x D 1000 mm 1.660 1.854 1.252 1.444</p>
 <p>1000 2600</p>	<p><b>Ellipse B meeting table</b></p> <p>3780 Ellipse B, L 3000 mm x D 1100 mm 1.891 2.085 1.632* 1.826*</p> <p>3778 Ellipse B, L 2800 mm x D 1100 mm 1.793 1.985 1.474* 1.667*</p> <p>3776 Ellipse B, L 2600 mm x D 1000 mm 1.726 1.918 1.316 1.511</p> <p>3774 Ellipse B, L 2400 mm x D 1000 mm 1.660 1.854 1.252 1.444</p> <p>3773 Ellipse B, L 2200 mm x D 900 mm 1.586 1.740 1.177 1.332</p> <p>3772 Ellipse B, L 2000 mm x D 900 mm 1.411 1.560 1.062 1.210</p> <p>3771 Ellipse B, L 1800 mm x D 900 mm 1.411 1.560 1.062 1.210</p>
 <p>1000 2600</p>	<p><b>Ellipse C meeting table</b></p> <p>3770 Ellipse C, L 3000 mm x D 1100 mm 1.891 2.085 1.632* 1.826*</p> <p>3768 Ellipse C, L 2800 mm x D 1100 mm 1.793 1.985 1.474* 1.667*</p> <p>3766 Ellipse C, L 2600 mm x D 1000 mm 1.726 1.918 1.316 1.511</p> <p>3764 Ellipse C, L 2400 mm x D 1000 mm 1.660 1.854 1.252 1.444</p> <p>3763 Ellipse C, L 2200 mm x D 900 mm 1.586 1.740 1.177 1.332</p> <p>3762 Ellipse C, L 2000 mm x D 900 mm 1.411 1.560 1.062 1.210</p> <p>3761 Ellipse C, L 1800 mm x D 900 mm 1.411 1.560 1.062 1.210</p>
 <p>1000 2600</p>	<p><b>Ellipse D meeting table</b></p> <p>3760 Ellipse D, L 3000 mm x D 1100 mm 1.891 2.085 1.632* 1.826*</p> <p>3758 Ellipse D, L 2800 mm x D 1100 mm 1.793 1.985 1.474* 1.667*</p> <p>3756 Ellipse D, L 2600 mm x D 1000 mm 1.726 1.918 1.316 1.511</p> <p>3754 Ellipse D, L 2400 mm x D 1000 mm 1.660 1.854 1.252 1.444</p> <p>3753 Ellipse D, L 2200 mm x D 900 mm 1.586 1.740 1.177 1.332</p> <p>3752 Ellipse D, L 2000 mm x D 900 mm 1.411 1.560 1.062 1.210</p> <p>3751 Ellipse D, L 1800 mm x D 900 mm 1.411 1.560 1.062 1.210</p>

Prices in EURO

\* The table has three columns.



# QUADRO Conference table (3 columns)

HPL, Veneer  
Nordic Nature

Linoleum  
XP laminate

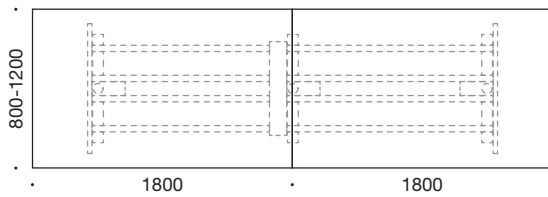

3600.3600	Length 3600 mm, H 720 mm Incl. 2 x assembly fittings 9126	2.554	2.864
3593	Surcharge : 3 columns with electrical sit / stand function	358	358

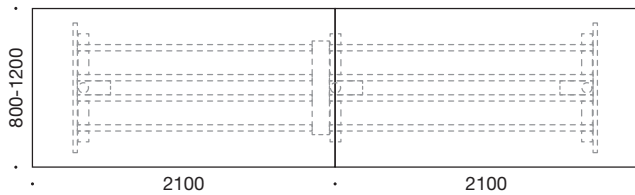

3600.4200	Length 4200 mm, H 720 mm Incl. 2 x assembly fittings 9126	2.624	2.935
3593	Surcharge : 3 columns with electrical sit / stand function	358	358

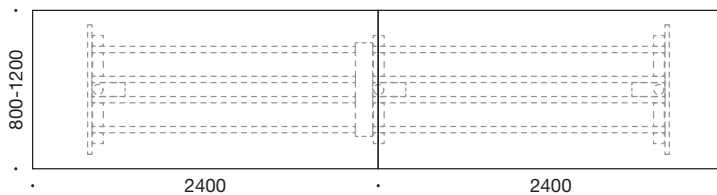

3600.4800	Length 4800 mm, H 720 mm Incl. 2 x assembly fittings 9126	3.383	3.770
3593	Surcharge : 3 columns with electrical sit / stand function	358	358

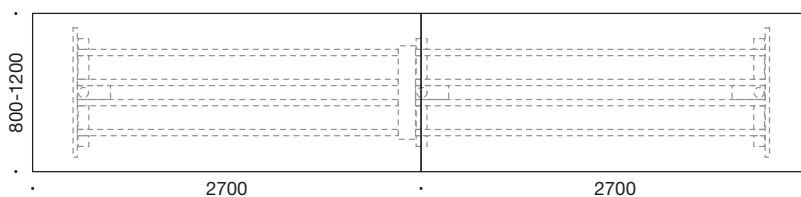

3600.5400	Length 5400 mm, H 720 mm Incl. 2 x assembly fittings 9126	3.383	3.770
3593	Surcharge : 3 columns with electrical sit / stand function	358	358

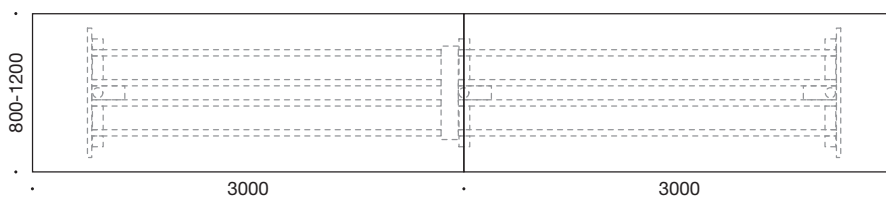

3600.6000	Length 6000 mm, H 720 mm Incl. 2 x assembly fittings 9126	3.383	3.770
3593	Surcharge : 3 columns with electrical sit / stand function	358	358

Please inform the requested shape on the table: barrel, trapez, rectangular or boat shaped.  
HPL : Table top in standard laminate (HPL) in Opaque White, Montana Grey, Platinum Grey, Anthracite Grey, Slate Grey, Volcanic Black or Lindberg Oak.

Prices in EURO

# AMIGO Conference table (3 & 4 columns)

HPL, Veneer  
Nordic Nature

Linoleum  
XP laminate

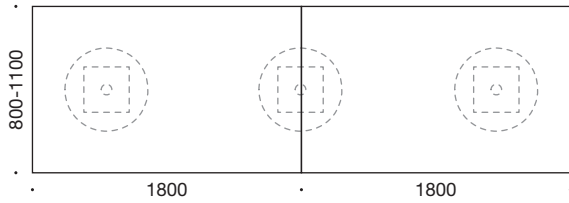

3900.3600

Length 3600 mm, H 743 mm  
Incl. 2 x assembly fittings 9126

1.457

1.768

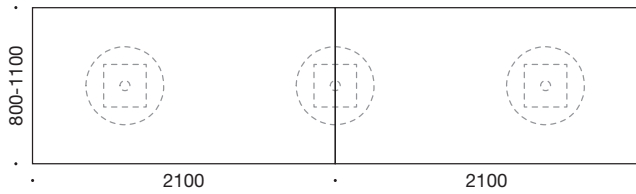

3900.4200

Length 4200 mm, H 743 mm  
Incl. 2 x assembly fittings 9126

1.528

1.839

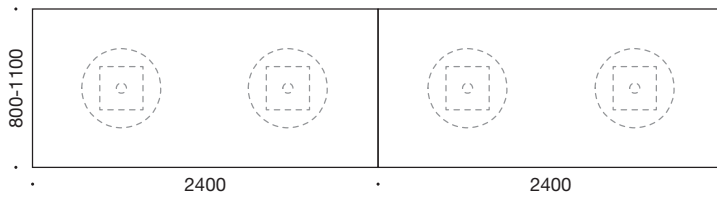

3900.4800

Length 4800 mm, H 743 mm  
Incl. 2 x assembly fittings 9126

2.479

2.866

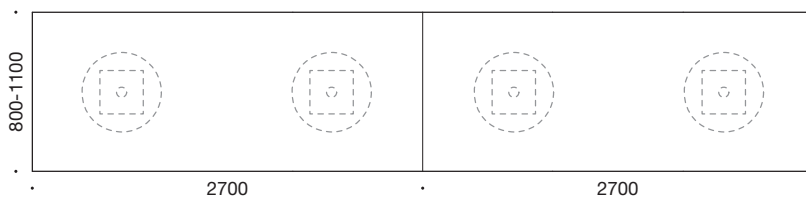

3900.5400

Length 5400 mm, H 743 mm  
Incl. 2 x assembly fittings 9126

2.479

2.866

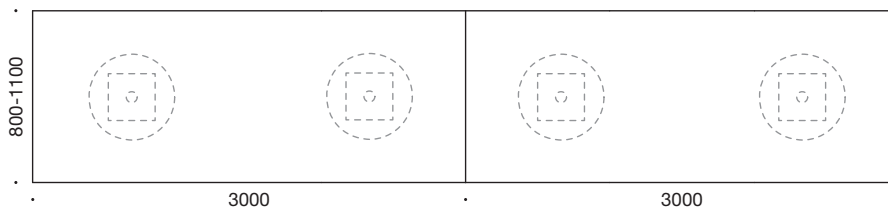

3900.6000



Length 6000 mm, H 743 mm  
Incl. 2 x assembly fittings 9126

2.594

2.982

# CONFERENCE Accessories

**Price**

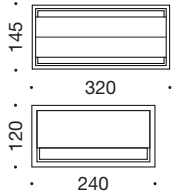
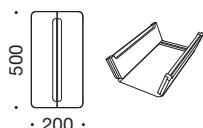
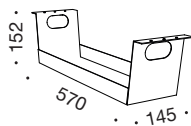
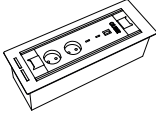
	<p><b>Powerstrip with alu case</b></p> <p>7500 Powerstrip incl. 6 x schuko plugs, USB-A, USB-C for charging 79</p>
	<p><b>Cable organizer</b></p> <p>7973 Cable organizer, 1450 mm 46</p>
 <p>3417 3425</p>	<p><b>Cable grommet (Incl. milling of cable hole)</b></p> <p>3417 Cable grommet in black metal with brushes and cover (320 mm x 145 mm) 121</p> <p>3425 Cable grommet in black metal (240 mm x 120 mm) 87</p> <p>3426 Cable grommet in black metal (160 mm x 80 mm) 52</p>
	<p><b>Cable grommet (Incl. milling of cable hole)</b></p> <p>3427 Cable grommet with brushes 419</p> <p>Available in laminate, veneer, linoleum or XP mat laminate</p>
	<p><b>Cable tray for meeting table</b></p> <p>3424 Cable tray in black metal 79</p>
	<p><b>Black connecting box (Incl. milling of cable hole)</b></p> <p>7501 Electrical rotatable connecting box (milled into the table top), black metal 350</p> <p>H 103 mm x L 340 mm x W 122 mm (hole 323 mm x 104 mm)</p> <p>Connectivity : 2 x 220V (Schuko), 2 x USB-C charging, HDMI 2.0 (4K, 60 HZ)</p>
	<p><b>Surcharge / accessories</b></p> <p>9126 Assembly fitting / links 17</p> <p>3410 Customized table top 84</p> <p>3260 Linoleum/HPL/XP over wooden edgee, up to 2200 mm 108</p> <p>3261 Linoleum/HPL/XP over wooden edge, 2201 mm - 3000 mm 204</p> <p>3287 Fenix laminate up to 1200 mm (surcharge to the linoleum price) 90</p> <p>3297 Fenix laminate, 1201-2200 mm (surcharge to the linoleum price) 136</p> <p>3277 Fenix laminate, 2201-3000 mm (surcharge to the linoleum price) 181</p> <p>3273 ABS/veneer on curved edge up to 2200 mm 139</p> <p>3274 ABS/veneer on curved edge from 2201-2800 mm 223</p> <p>3414 Linoleum cleaner 1L 31</p> <p>3415 Laminate cleaner 1L 23</p> <p>3445 Sponge for surfaces 4</p> <p><b>Only for Quadro frames</b></p> <p>3594 Set of castors for Quadro table under 3000 mm , set of 4 psc. 90</p> <p>3595 Set of castors for Quadro table over 3000 mm , set of 6 psc. 90</p> <p>3409 Column - chrome per. set (2 columns, frame in black) (surcharge) 162</p> <p>3406 Foot - chrome per. set (2 feet, frame in black) (surcharge) 201</p> <p>3592 Quadro frame 2 columns with sit / stand function (surcharge) 191</p> <p>3593 Quadro frame 3 columns with sit / stand function (surcharge) 358</p> <p><b>Only for Amigo frames</b></p> <p>0570 Surcharge for column and foot in alu or white (surcharge) 83</p>

Prices in EURO

## MEETING / CANTEEN TABLES



Table top (23 mm) available in :

- **Veneer** : maple, ash, beech, oak, cherry or walnut
- **Standard laminate (HPL)**: Opaque White, Montana Grey, Platinum Grey, Anthracite Grey, Slate Grey, Volcanic Black or Lindberg Oak
- **Nordic Nature (HPL)**
- **XP mat laminate**
- **Linoleum**

7 x lacquer on veneer and  
3 x lacquer on edges

Veneered plates with straight edges are made with wooden edge.

Laminate plates with straight edges are made with ABS-edges.

Note that only Sensa and RAW have both table top and frame.

\*Surcharge on page 125.

### Meeting / canteen tables in general :

- 4 editions :
  - Sensa table (40x40 mm) with a black or alu frame, H 745 mm
  - RAW table with a white, alu or black frame, H 740 mm
  - Amigo column (Ø 90 mm) in brushed stainless steel, black, white, or alu\*, H 545 / 720 / 900 / 1020 mm
  - Cross column (Ø 76 mm) in black, white or alu, H 720 mm
- Rectangular or round table top in 23 mm MDF with bevelled or straight edge
- Choose between 4 different surfaces for the table tops
- Rectangular table tops with bevelled edge and radius 20 on corners
- Rectangular table tops with straight edges and radius 2 on corners
- ABS-edges available in all standard laminate colors as well as maple, beech, oak and plywood
- Wooden edges available in maple, ash, beech, oak, cherry or walnut
- 5 years warranty

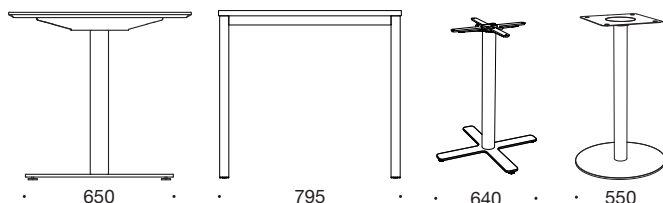



# MEETING / CANTEEN Tables

**HPL, Veneer  
 Nordic Nature**
**Linoleum  
 XP laminate**

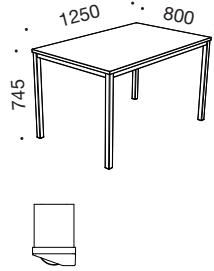
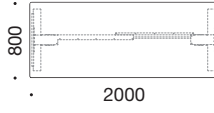
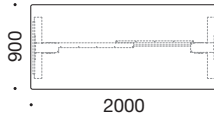
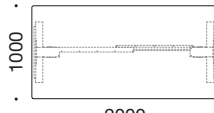
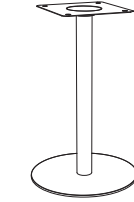
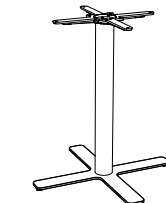
	<p><b>Sensa table with adjustable feet, H 745 mm</b></p> <table border="0"> <tr> <td>0604</td> <td>1250 mm x 800 mm</td> <td>501</td> <td>580</td> </tr> <tr> <td>0606</td> <td>1850 mm x 800 mm</td> <td>601</td> <td>680</td> </tr> <tr> <td>0607</td> <td>800 mm x 800 mm</td> <td>416</td> <td>488</td> </tr> <tr> <td>0608</td> <td>1250 mm x 1250 mm (not supplied in Veneer)</td> <td>559</td> <td>631</td> </tr> <tr> <td>0602</td> <td>Shoes with castors, 4 pcs.</td> <td>41</td> <td>41</td> </tr> <tr> <td>0601</td> <td>Chair suspension for Vesper 1 chair, per set</td> <td>60</td> <td>60</td> </tr> </table>	0604	1250 mm x 800 mm	501	580	0606	1850 mm x 800 mm	601	680	0607	800 mm x 800 mm	416	488	0608	1250 mm x 1250 mm (not supplied in Veneer)	559	631	0602	Shoes with castors, 4 pcs.	41	41	0601	Chair suspension for Vesper 1 chair, per set	60	60
0604	1250 mm x 800 mm	501	580																						
0606	1850 mm x 800 mm	601	680																						
0607	800 mm x 800 mm	416	488																						
0608	1250 mm x 1250 mm (not supplied in Veneer)	559	631																						
0602	Shoes with castors, 4 pcs.	41	41																						
0601	Chair suspension for Vesper 1 chair, per set	60	60																						
	<p><b>RAW table, H 740 mm</b></p> <table border="0"> <tr> <td>4720</td> <td>2000 x 800 mm</td> <td>699</td> <td>830</td> </tr> <tr> <td>4718</td> <td>1800 x 800 mm</td> <td>699</td> <td>830</td> </tr> <tr> <td>4716</td> <td>1600 x 800 mm</td> <td>699</td> <td>830</td> </tr> <tr> <td>4714</td> <td>1400 x 800 mm</td> <td>699</td> <td>830</td> </tr> <tr> <td>4712</td> <td>1200 x 800 mm</td> <td>699</td> <td>830</td> </tr> </table>	4720	2000 x 800 mm	699	830	4718	1800 x 800 mm	699	830	4716	1600 x 800 mm	699	830	4714	1400 x 800 mm	699	830	4712	1200 x 800 mm	699	830				
4720	2000 x 800 mm	699	830																						
4718	1800 x 800 mm	699	830																						
4716	1600 x 800 mm	699	830																						
4714	1400 x 800 mm	699	830																						
4712	1200 x 800 mm	699	830																						
	<p><b>RAW table, H 740 mm</b></p> <table border="0"> <tr> <td>4740</td> <td>2000 x 900 mm</td> <td>699</td> <td>830</td> </tr> <tr> <td>4738</td> <td>1800 x 900 mm</td> <td>699</td> <td>830</td> </tr> <tr> <td>4736</td> <td>1600 x 900 mm</td> <td>699</td> <td>830</td> </tr> <tr> <td>4734</td> <td>1400 x 900 mm</td> <td>699</td> <td>830</td> </tr> <tr> <td>4732</td> <td>1200 x 900 mm</td> <td>699</td> <td>830</td> </tr> </table>	4740	2000 x 900 mm	699	830	4738	1800 x 900 mm	699	830	4736	1600 x 900 mm	699	830	4734	1400 x 900 mm	699	830	4732	1200 x 900 mm	699	830				
4740	2000 x 900 mm	699	830																						
4738	1800 x 900 mm	699	830																						
4736	1600 x 900 mm	699	830																						
4734	1400 x 900 mm	699	830																						
4732	1200 x 900 mm	699	830																						
	<p><b>RAW table, H 740 mm</b></p> <table border="0"> <tr> <td>4730</td> <td>2000 x 1000 mm</td> <td>699</td> <td>830</td> </tr> <tr> <td>4728</td> <td>1800 x 1000 mm</td> <td>699</td> <td>830</td> </tr> <tr> <td>4726</td> <td>1600 x 1000 mm</td> <td>699</td> <td>830</td> </tr> <tr> <td>4724</td> <td>1400 x 1000 mm</td> <td>699</td> <td>830</td> </tr> <tr> <td>4722</td> <td>1200 x 1000 mm</td> <td>699</td> <td>830</td> </tr> </table>	4730	2000 x 1000 mm	699	830	4728	1800 x 1000 mm	699	830	4726	1600 x 1000 mm	699	830	4724	1400 x 1000 mm	699	830	4722	1200 x 1000 mm	699	830				
4730	2000 x 1000 mm	699	830																						
4728	1800 x 1000 mm	699	830																						
4726	1600 x 1000 mm	699	830																						
4724	1400 x 1000 mm	699	830																						
4722	1200 x 1000 mm	699	830																						
	<p style="text-align: right;"><b>Price</b></p> <p><b>Amigo column for plates 600 - 1100 mm</b></p> <table border="0"> <tr> <td>0506.0000</td> <td>Amigo column, Ø 550 mm x H 545 mm</td> <td>281</td> </tr> <tr> <td>0506.0010</td> <td>Amigo column, Ø 550 mm x H 720 mm</td> <td>281</td> </tr> <tr> <td>0506.0015</td> <td>Amigo column, Ø 550 mm x H 900 mm</td> <td>305</td> </tr> <tr> <td>0506.0020</td> <td>Amigo column, Ø 550 mm x H 1020 mm</td> <td>316</td> </tr> </table> <p><b>Amigo column for plates 1100 - 1200 mm</b></p> <table border="0"> <tr> <td>0507.0010</td> <td>Amigo column, Ø 720 mm x H 720 mm - flat packed</td> <td>473</td> </tr> </table>	0506.0000	Amigo column, Ø 550 mm x H 545 mm	281	0506.0010	Amigo column, Ø 550 mm x H 720 mm	281	0506.0015	Amigo column, Ø 550 mm x H 900 mm	305	0506.0020	Amigo column, Ø 550 mm x H 1020 mm	316	0507.0010	Amigo column, Ø 720 mm x H 720 mm - flat packed	473									
0506.0000	Amigo column, Ø 550 mm x H 545 mm	281																							
0506.0010	Amigo column, Ø 550 mm x H 720 mm	281																							
0506.0015	Amigo column, Ø 550 mm x H 900 mm	305																							
0506.0020	Amigo column, Ø 550 mm x H 1020 mm	316																							
0507.0010	Amigo column, Ø 720 mm x H 720 mm - flat packed	473																							
	<p><b>Cross column for plates 600 - 800 mm</b></p> <table border="0"> <tr> <td>0500</td> <td>Cross column, Ø 640 mm x H 720 mm</td> <td>281</td> </tr> </table> <p>Please inform which color you want: black, white or alu.</p>	0500	Cross column, Ø 640 mm x H 720 mm	281																					
0500	Cross column, Ø 640 mm x H 720 mm	281																							



# MEETING / CANTEEN Table tops

**Price**

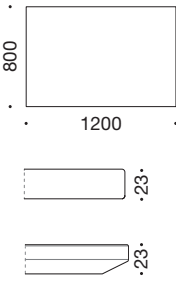
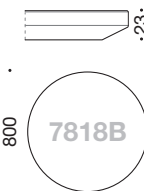
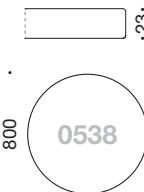
		HPL, Veneer Nordic Nature	Linoleum XP laminate
<b>Surcharge</b>			
	0570 Surcharge for Amigo column and foot in alu or white		83
	3419 Metal rail (extra support for table tops longer than 1200 mm)		53
<b>Table tops with straight ABS / wooden edge or bevelled edge, 23 mm</b>			
	0508B Table top, 800 mm x 800 mm	196	279
	0509B Table top, 900 mm x 800 mm	211	293
	0510B Table top, 1000 mm x 800 mm	211	293
	0511B Table top, 1100 mm x 800 mm	239	321
	0512B Table top, 1200 mm x 800 mm	239	321
	0513B Table top, 1300 mm x 800 mm	266	398
	0514B Table top, 1400 mm x 800 mm	266	398
	0515B Table top, 1500 mm x 800 mm	294	427
	0516B Table top, 1600 mm x 800 mm	294	427
	0517B Table top, 1700 mm x 800 mm	321	454
	0518B Table top, 1800 mm x 800 mm	321	454
<b>Round table top with bevelled edge, 23 mm</b>			
	7816B Round plate with bevelled edge, Ø 600 mm	183	269
	7817B Round plate with bevelled edge, Ø 700 mm	191	277
	7818B Round plate with bevelled edge, Ø 800 mm	196	279
	7819B Round plate with bevelled edge, Ø 900 mm	211	293
	7820B Round plate with bevelled edge, Ø 1000 mm	211	293
	7821B Round plate with bevelled edge, Ø 1100 mm	239	321
	7822B Round plate with bevelled edge, Ø 1200 mm	255	337
	<b>Round table top with straight ABS / wooden edge, 23 mm</b>		
	0536B Round plate with straight edge, Ø 600 mm	279	362
	0537B Round plate with straight edge, Ø 700 mm	300	382
	0538B Round plate with straight edge, Ø 800 mm	319	402
	0539B Round plate with straight edge, Ø 900 mm	328	410
	0540B Round plate with straight edge, Ø 1000 mm	338	420
	0541B Round plate with straight edge, Ø 1100 mm	349	431
	0542B Round plate with straight edge, Ø 1200 mm	376	458
<b>Surcharge for table tops</b>			
	3410 Customized plates		84
	3260 Linoleum/HPL/XP over wooden edge, up to 2200 mm		108
	3287 Fenix laminate up to 1200 mm (surcharge to the linoleum price)		90
	3297 Fenix laminate, 1201-2200 mm (surcharge to the linoleum price)		136
	3277 Fenix laminate, 2201-3000 mm (surcharge to the linoleum price)		181

Prices in EURO



## FLAP FOLDING TABLE



Table top available in :

- **Veneer** : maple, ash, beech, oak, cherry or walnut
- **Standard laminate (HPL)**: Opaque White, Montana Grey, Platinum Grey, Anthracite Grey, Slate Grey, Volcanic Black or Lindberg Oak
- **Nordic Nature (HPL)**
- **XP mat laminate**
- **Linoleum**

7 x lacquer on veneer and  
3 x lacquer on edges

Veneered plates with straight edges are made with wooden edge.

### Flap folding tables in general :

- Rectangular frame in black, alu or white, 40 x 60 mm
- The frame is always black
- Feet in solid steel with castors, L 650 mm
- 4 lockable castors
- Height 740 mm
- Very stable frame
- Table tops in 23 mm MDF
- Choose between 4 different surfaces for the table top
- Rectangular table tops with straight edges and radius 2 on corners
- ABS-edges available in all standard laminate colors as well as maple, beech, oak and plywood
- Wooden edges available in maple, ash, beech, oak, cherry or walnut
- EN15372:2016 tested
- 5 years warranty

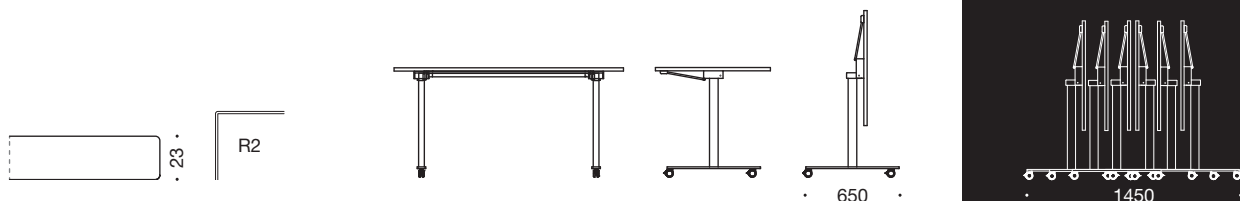

**FLAP** Folding table

HPL, Veneer  
Nordic Nature

Linoleum  
XP laminate

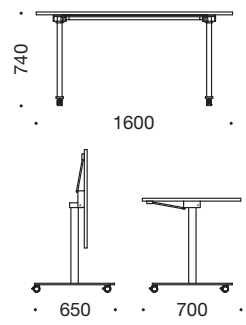

**Flap folding table, D 700 mm**

3320	2000 x 700 mm	977	1.113
3318	1800 x 700 mm	970	1.105
3316	1600 x 700 mm	961	1.097
3314	1400 x 700 mm	946	1.082
3312	1200 x 700 mm	930	1.066

The folding table is always with a black rail.

Use coupling fittings to connect the tables.

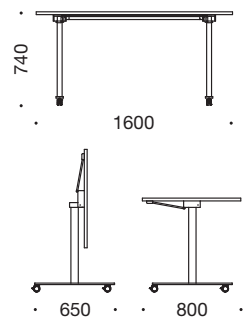

**Flap folding table, D 800 mm**

3330	2000 x 800 mm	977	1.113
3328	1800 x 800 mm	970	1.105
3326	1600 x 800 mm	961	1.097
3324	1400 x 800 mm	946	1.082
3322	1200 x 800 mm	930	1.066

The folding table is always with a black rail.

Use coupling fittings to connect the tables.

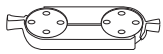

**Coupling fitting**

3413	Coupling fitting, per pcs.		<b>Price</b> 20
------	----------------------------	--	--------------------

You need two coupling fitting to connect two tables.

**Surcharge**

3260	Linoleum/HPL/XP over wooden edge, up to 2200 mm	108
3287	Fenix laminate up to 1200 mm (surcharge to the linoleum price)	90
3297	Fenix laminate, 1201-2200 mm (surcharge to the linoleum price)	136
3277	Fenix laminate, 2201-3000 mm (surcharge to the linoleum price)	181

## V FOLDING TABLE



Table top available in :

- **Veneer** : maple, ash, beech, oak, cherry or walnut
- **Standard laminate (HPL)**: Opaque White, Montana Grey, Platinum Grey, Anthracite Grey, Slate Grey, Volcanic Black or Lindberg Oak
- **Nordic Nature (HPL)**
- **XP mat laminate**
- **Linoleum**

7 x lacquer on veneer and  
3 x lacquer on edges

Veneered plates with straight edges are made with wooden edge.

### V folding tables in general :

- V-frame in black, alu or white
- The frame is always black
- 4 lockable castors
- Height 730 mm
- Table tops in 23 mm MDF
- Choose between 4 different surfaces for the table top
- Rectangular table tops with straight edges and radius 2 on corners
- ABS-edges available in all standard laminate colors as well as maple, beech, oak and plywood
- Wooden edges available in maple, ash, beech, oak, cherry or walnut
- 5 years warranty

R2

23

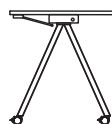

615

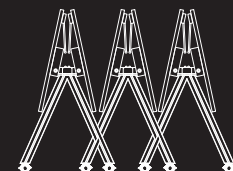

1590

**V Folding table**

**HPL, Veneer  
Nordic Nature**      **Linoleum  
XP laminate**

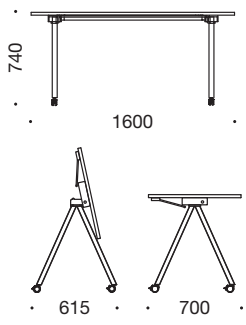
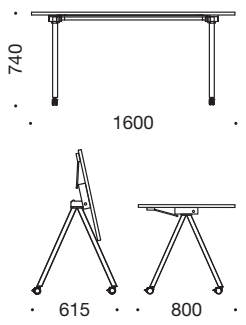
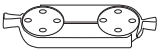
	<p><b>V folding table, D 700 mm</b></p> <table border="1"> <tbody> <tr> <td>3820</td> <td>2000 x 700 mm</td> <td>891</td> <td>1.027</td> </tr> <tr> <td>3818</td> <td>1800 x 700 mm</td> <td>883</td> <td>1.019</td> </tr> <tr> <td>3816</td> <td>1600 x 700 mm</td> <td>875</td> <td>1.011</td> </tr> <tr> <td>3814</td> <td>1400 x 700 mm</td> <td>860</td> <td>996</td> </tr> <tr> <td>3812</td> <td>1200 x 700 mm</td> <td>844</td> <td>980</td> </tr> </tbody> </table> <p>The folding table is always with a black rail.</p> <p>Use coupling fittings to connect the tables.</p>	3820	2000 x 700 mm	891	1.027	3818	1800 x 700 mm	883	1.019	3816	1600 x 700 mm	875	1.011	3814	1400 x 700 mm	860	996	3812	1200 x 700 mm	844	980	
3820	2000 x 700 mm	891	1.027																			
3818	1800 x 700 mm	883	1.019																			
3816	1600 x 700 mm	875	1.011																			
3814	1400 x 700 mm	860	996																			
3812	1200 x 700 mm	844	980																			
	<p><b>V folding table, D 800 mm</b></p> <table border="1"> <tbody> <tr> <td>3830</td> <td>2000 x 800 mm</td> <td>891</td> <td>1.027</td> </tr> <tr> <td>3828</td> <td>1800 x 800 mm</td> <td>883</td> <td>1.019</td> </tr> <tr> <td>3826</td> <td>1600 x 800 mm</td> <td>875</td> <td>1.011</td> </tr> <tr> <td>3824</td> <td>1400 x 800 mm</td> <td>860</td> <td>996</td> </tr> <tr> <td>3822</td> <td>1200 x 800 mm</td> <td>844</td> <td>980</td> </tr> </tbody> </table> <p>The folding table is always with a black rail.</p> <p>Use coupling fittings to connect the tables.</p>	3830	2000 x 800 mm	891	1.027	3828	1800 x 800 mm	883	1.019	3826	1600 x 800 mm	875	1.011	3824	1400 x 800 mm	860	996	3822	1200 x 800 mm	844	980	
3830	2000 x 800 mm	891	1.027																			
3828	1800 x 800 mm	883	1.019																			
3826	1600 x 800 mm	875	1.011																			
3824	1400 x 800 mm	860	996																			
3822	1200 x 800 mm	844	980																			
	<p><b>Coupling fitting</b></p> <table border="1"> <tbody> <tr> <td>3413</td> <td>Coupling fitting, per pcs.</td> <td></td> <td><b>Price</b></td> </tr> <tr> <td></td> <td></td> <td></td> <td>20</td> </tr> </tbody> </table> <p>You need two coupling fitting to connect two tables.</p>	3413	Coupling fitting, per pcs.		<b>Price</b>				20													
3413	Coupling fitting, per pcs.		<b>Price</b>																			
			20																			
	<p><b>Surcharge</b></p> <table border="1"> <tbody> <tr> <td>3260</td> <td>Linoleum/HPL/XP over wooden edge, up to 2200 mm</td> <td></td> <td>108</td> </tr> <tr> <td>3287</td> <td>Fenix laminate up to 1200 mm (surcharge to the linoleum price)</td> <td></td> <td>90</td> </tr> <tr> <td>3297</td> <td>Fenix laminate, 1201-2200 mm (surcharge to the linoleum price)</td> <td></td> <td>136</td> </tr> <tr> <td>3277</td> <td>Fenix laminate, 2201-3000 mm (surcharge to the linoleum price)</td> <td></td> <td>181</td> </tr> </tbody> </table>	3260	Linoleum/HPL/XP over wooden edge, up to 2200 mm		108	3287	Fenix laminate up to 1200 mm (surcharge to the linoleum price)		90	3297	Fenix laminate, 1201-2200 mm (surcharge to the linoleum price)		136	3277	Fenix laminate, 2201-3000 mm (surcharge to the linoleum price)		181					
3260	Linoleum/HPL/XP over wooden edge, up to 2200 mm		108																			
3287	Fenix laminate up to 1200 mm (surcharge to the linoleum price)		90																			
3297	Fenix laminate, 1201-2200 mm (surcharge to the linoleum price)		136																			
3277	Fenix laminate, 2201-3000 mm (surcharge to the linoleum price)		181																			

## LITE CUBE GABLE TABLE



### Lite Cube gable table in general :

- Made in 30 mm plates
- 7 colors in standard laminate
- 6 different veneers
- Choose between 4 different surfaces for the table tops
- ABS-edges available in all standard laminate colors as well as maple, beech or oak
- Wooden edges available in maple, ash, beech, oak, cherry or walnut
- Support in stainless steel
- Built-in castors in one end of Lite Cube\*
- Delivered flat packed
- 5 years warranty

Gable table available in :

- **Veneer** : maple, ash, beech, oak, cherry or walnut
- **Standard laminate (HPL)**: Opaque White, Montana Grey, Platinum Grey, Anthracite Grey, Slate Grey, Volcanic Black or Lindberg Oak

Top plate available in :

- **Veneer** : maple, ash, beech, oak, cherry or walnut
- **Standard laminate (HPL)**: Opaque White, Montana Grey, Platinum Grey, Anthracite Grey, Slate Grey, Volcanic Black or Lindberg Oak
- **Nordic Nature (HPL)**
- **XP mat laminate**
- **Linoleum**

7 x lacquer on veneer and  
3 x lacquer on edges

Thickness of plates :

- 30 mm

Edge :

- ABS-edge
- Wooden edge

Support :

- Stainless steel

\*Surcharge

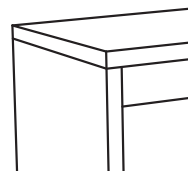

# LITE CUBE Gable table

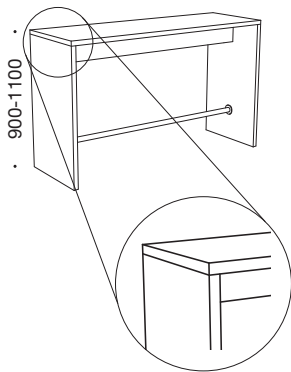
**HPL, Veneer**  
**Nordic Nature**
**Veneer:**  
**Cherry**  
**Walnut**

**Lite Cube gable table, D 600 mm**

3549	2360 x 600 mm	1.431	1.789
3544	2160 x 600 mm	1.352	1.689
3540	1960 x 600 mm	1.260	1.576
3538	1760 x 600 mm	1.260	1.576
3536	1560 x 600 mm	1.260	1.576
3534	1360 x 600 mm	1.260	1.576
3532	1160 x 600 mm	1.260	1.576

Foot support in stainless steel.

Lite Cube is made with impact-resistant ABS-edges.

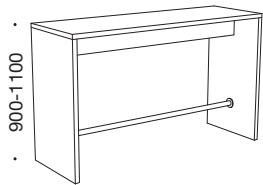
Delivered flat packed.

**Lite Cube gable table, D 800 mm**

3564	2360 x 800 mm	1.675	2.034
3562	2160 x 800 mm	1.596	1.933
3560	1960 x 800 mm	1.504	1.819
3558	1760 x 800 mm	1.504	1.819
3556	1560 x 800 mm	1.504	1.819
3554	1360 x 800 mm	1.504	1.819
3552	1160 x 800 mm	1.504	1.819

Foot support in stainless steel.

Lite Cube is made with impact-resistant ABS-edges.

Delivered flat packed.

**Surcharge**

		<b>Price</b>
3402	Linoleum or XP mat laminate up to 1200 mm (on top plate)	86
3400	Linoleum or XP mat laminate 1201 mm - 2200 mm (on top plate)	132
3403	Linoleum or XP mat laminate 2201 mm - 3000 mm (on top plate)	160
3525	Built-in castors in one end of Lite Cube	327
3287	Fenix laminate up to 1200 mm (surcharge to the linoleum price)	90
3297	Fenix laminate, 1201-2200 mm (surcharge to the linoleum price)	136
3277	Fenix laminate, 2201-3000 mm (surcharge to the linoleum price)	181



## INFORMATION DESKS



Information desks available in :

- **Veneer** : maple, ash, beech, oak or walnut
- **Laminate** : Opaque White, Montana Grey, Platinum Grey, Anthracite Grey, Slate Grey, Volcanic Black or Lindberg Oak
- **Nordic Nature (HPL)**
- **XP mat laminate\***
- **Linoleum\***

7 x lacquer on veneer and  
3 x lacquer on edges

\* Note surcharge see page 135.

### Information desks in general :

- 3 variations : modular desks, Quadro information desks and Lite Cube information desks
- 5 years warranty



# INFORMATION DESK

Laminate

Veneer

XP laminate  
Nordic Nature

## Modular desk

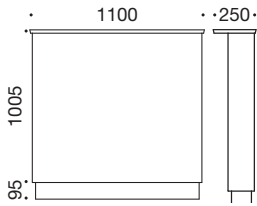

### Modular information desk - H 1100 mm

3110	Modular information desk, Front (corner)	980	1.088	1.359
3111	Modular information desk, Side (corner)	980	1.088	1.359
3112	Modular information desk	980	1.088	1.359

Module: W 1100 x D 250 / 150 mm. Max width per module : 1200 mm  
Modular based information desk system - can be customized.

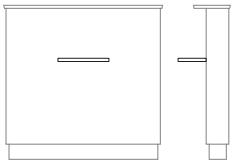

### Bag shelf with straight edges for the modular desk

3100H	Bag shelf, W 400 mm x D 180 mm x H 23 mm	207	207	258
-------	--	-----	-----	-----

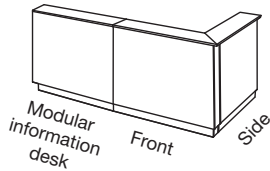

### Price example - Information desk

4 pcs. module  
A sit / stand desk 1800 mm x 800 mm can fit into the information desk.  
Plinth in alu (brushed) and top panel in white laminate.

Total price		3.920	4.352	5.436
-------------	--	-------	-------	-------

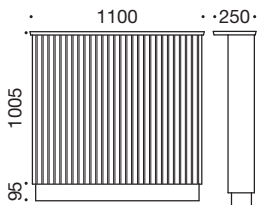

### Modular desk with slats - H 1100 mm

3130	Modular information desk, Front (corner)	1.346	1.464	1.830
3131	Modular information desk, Side (corner)	1.346	1.464	1.830
3132	Modular information desk	1.346	1.464	1.830

Module with slats, W 1100 x D 250 / 150 mm. Max width per module : 1100 mm  
Slats made of black or brown MDF.  
Modular based information desk system with slats can be customized.

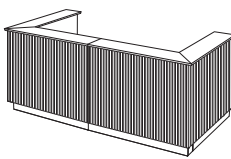

### Price example - Information desk with slats

4 pcs. module with slats  
A sit / stand desk 1800 mm x 800 mm can fit into the information desk.

Total price		5.384	5.856	7.320
-------------	--	-------	-------	-------

## Illustration

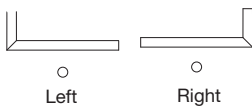

### Please inform right / left when ordering (see illustration)

- 1 Left-facing L-desk
- 2 Right-facing L-desk

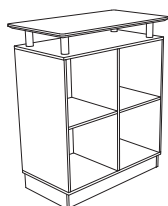

### 2-room wide Quadro information desk with raised top plate, D 430 mm

5351	Bookcase	340	415	
5496	Top plate H 23 mm x L 854 mm x D 480 mm	107	107	
5415	4 x Alu-spacer (100 mm)	164	164	
5412	Plinth, H 95 mm	76	90	

Total price		687	776	
-------------	--	-----	-----	--

Prices in EURO

# INFORMATION DESK

**Laminate**
**Veneer**
**XP laminate  
Nordic Nature**

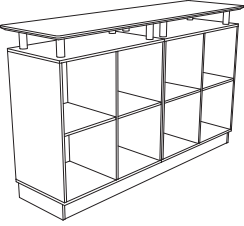
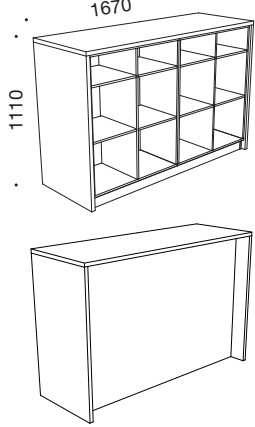
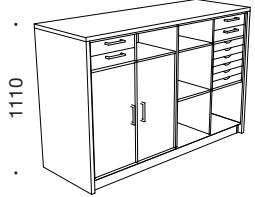
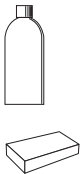
	<p><b>4-room wide Quadro information desk with raised top plate, D 430 mm</b></p> <table border="0"> <tr> <td>5351</td> <td>2 x Bookcase</td> <td>680</td> <td>830</td> </tr> <tr> <td>5497</td> <td>Top plate H 23 mm x L 1658 mm x D 480 mm</td> <td>279</td> <td>279</td> </tr> <tr> <td>5415</td> <td>8 x Alu-spacer (100 mm)</td> <td>328</td> <td>328</td> </tr> <tr> <td>3156</td> <td>Plinth, H 95 mm</td> <td>183</td> <td>217</td> </tr> <tr> <td colspan="2">Total price</td> <td>1.470</td> <td>1.654</td> </tr> </table>	5351	2 x Bookcase	680	830	5497	Top plate H 23 mm x L 1658 mm x D 480 mm	279	279	5415	8 x Alu-spacer (100 mm)	328	328	3156	Plinth, H 95 mm	183	217	Total price		1.470	1.654																
5351	2 x Bookcase	680	830																																		
5497	Top plate H 23 mm x L 1658 mm x D 480 mm	279	279																																		
5415	8 x Alu-spacer (100 mm)	328	328																																		
3156	Plinth, H 95 mm	183	217																																		
Total price		1.470	1.654																																		
<p><b>Lite Cube desk</b></p> 	<p><b>Lite Cube information desk - 30 mm plate</b> H 1110 mm x L 1670 mm x D 600 mm</p> <table border="0"> <tr> <td></td> <td></td> <td>2.409</td> <td>2.778</td> </tr> </table> <p>Lite Cube information desk contains :</p> <table border="0"> <tr> <td>3570</td> <td>Lite Cube bridge with backing</td> <td>1.350</td> <td>1.513</td> </tr> <tr> <td>5355</td> <td>2 x Bookcase</td> <td>876</td> <td>1.048</td> </tr> <tr> <td>3156</td> <td>Plinth, H 95 mm</td> <td>183</td> <td>217</td> </tr> </table> <p>Lite Cube made with impact-resistant ABS-edge. Delivered knock-down.</p>			2.409	2.778	3570	Lite Cube bridge with backing	1.350	1.513	5355	2 x Bookcase	876	1.048	3156	Plinth, H 95 mm	183	217																				
		2.409	2.778																																		
3570	Lite Cube bridge with backing	1.350	1.513																																		
5355	2 x Bookcase	876	1.048																																		
3156	Plinth, H 95 mm	183	217																																		
	<p><b>Price example : Lite Cube information desk</b> Lite Cube information desk with standard Quadro storage.</p> <table border="0"> <tr> <td>Total price</td> <td></td> <td>3.431</td> <td>3.484</td> </tr> </table>	Total price		3.431	3.484																																
Total price		3.431	3.484																																		
	<p><b>Surcharge</b></p> <table border="0"> <thead> <tr> <th></th> <th></th> <th></th> <th style="text-align: right;"><b>Price</b></th> </tr> </thead> <tbody> <tr> <td>3401</td> <td>Nordic Nature (HPL) on top panel, per module</td> <td></td> <td style="text-align: right;">81</td> </tr> <tr> <td>3402</td> <td>Linoleum or XP mat laminate on top panel (modular desks), per module</td> <td></td> <td style="text-align: right;">86</td> </tr> <tr> <td>3400</td> <td>Linoleum or XP mat laminate 1201-2200 mm (on Lite Cube top plate)</td> <td></td> <td style="text-align: right;">132</td> </tr> <tr> <td>3403</td> <td>Linoleum or XP mat laminate 2201-3000 mm (on Lite Cube top plate)</td> <td></td> <td style="text-align: right;">160</td> </tr> <tr> <td>3467</td> <td>Fenix laminate on top panel, per module</td> <td></td> <td style="text-align: right;">90</td> </tr> <tr> <td>3287</td> <td>Fenix laminate up to 1200 mm (surcharge to the linoleum price)</td> <td></td> <td style="text-align: right;">90</td> </tr> <tr> <td>3297</td> <td>Fenix laminate, 1201-2200 mm (surcharge to the linoleum price)</td> <td></td> <td style="text-align: right;">136</td> </tr> <tr> <td>3277</td> <td>Fenix laminate, 2201-3000 mm (surcharge to the linoleum price)</td> <td></td> <td style="text-align: right;">181</td> </tr> </tbody> </table>				<b>Price</b>	3401	Nordic Nature (HPL) on top panel, per module		81	3402	Linoleum or XP mat laminate on top panel (modular desks), per module		86	3400	Linoleum or XP mat laminate 1201-2200 mm (on Lite Cube top plate)		132	3403	Linoleum or XP mat laminate 2201-3000 mm (on Lite Cube top plate)		160	3467	Fenix laminate on top panel, per module		90	3287	Fenix laminate up to 1200 mm (surcharge to the linoleum price)		90	3297	Fenix laminate, 1201-2200 mm (surcharge to the linoleum price)		136	3277	Fenix laminate, 2201-3000 mm (surcharge to the linoleum price)		181
			<b>Price</b>																																		
3401	Nordic Nature (HPL) on top panel, per module		81																																		
3402	Linoleum or XP mat laminate on top panel (modular desks), per module		86																																		
3400	Linoleum or XP mat laminate 1201-2200 mm (on Lite Cube top plate)		132																																		
3403	Linoleum or XP mat laminate 2201-3000 mm (on Lite Cube top plate)		160																																		
3467	Fenix laminate on top panel, per module		90																																		
3287	Fenix laminate up to 1200 mm (surcharge to the linoleum price)		90																																		
3297	Fenix laminate, 1201-2200 mm (surcharge to the linoleum price)		136																																		
3277	Fenix laminate, 2201-3000 mm (surcharge to the linoleum price)		181																																		
	<p><b>Cleaning products</b></p> <table border="0"> <tr> <td>3414</td> <td>Linoleum cleaner 1L</td> <td></td> <td style="text-align: right;">31</td> </tr> <tr> <td>3415</td> <td>Laminate cleaner 1L</td> <td></td> <td style="text-align: right;">23</td> </tr> <tr> <td>3445</td> <td>Sponge for surfaces</td> <td></td> <td style="text-align: right;">4</td> </tr> </table>	3414	Linoleum cleaner 1L		31	3415	Laminate cleaner 1L		23	3445	Sponge for surfaces		4																								
3414	Linoleum cleaner 1L		31																																		
3415	Laminate cleaner 1L		23																																		
3445	Sponge for surfaces		4																																		

Prices in EURO

---

# TERMS & CONDITIONS

---

## §1 General

These general sale & delivery terms shall be in effect for any agreement entered into between Cube Design A/S (hereinafter Cube Design) and its customers (hereinafter Buyer), unless the parties specifically agree otherwise in writing.

## §2 Entering into an Agreement, etc.

An agreement has only been entered into when Cube Design has issued an order confirmation, invoice or other corresponding written agreement, and the conditions specified therein shall form the basis of the agreement. All prices indicated in the price list are specified excluding packaging, including for example pallets and containers, and also excluding taxes, VAT and other duties. Cube Design reserves the right to regulate the indicated prices without prior notice, in the event of an increase in the price of raw materials, production costs, transport expenses, packaging or other sudden changes to the cost levels. All agreements are thus entered into on the basis of the prices that apply at the time the order is received.

The basis of the agreement is constituted by the information specified in the order confirmation, invoice or other corresponding agreement, including in relation to price, materials, conditions, etc., since other information can only be regarded as a guideline and if necessary will be rectified at the time the agreement is entered into. Unless otherwise expressly stated in the written agreement, the goods are sold with the intended purpose of normal and ordinary use.

## §3 Payment Etc.

Payment shall be made in accordance with the payment terms specified on the invoice, which as a general rule means that the payment must be carried out in cash no later than 30 days of the invoice date ("Net 30"), unless otherwise specifically agreed. The Buyer is not entitled to withhold any part of his payment and may not otherwise fulfill his liabilities through set-offs or similar. In case of delayed payment, Cube Design is entitled to charge interest at a rate of 2% for each month or part of a month and, depending on the circumstances, may also fully or partially postpone subsequent deliveries, establish special payment terms or also, if necessary, terminate agreements with the respective party. Cube Design will send all invoices by email.

## §4 Ownership Reservation

Cube Design will retain the right of ownership of all goods that are specified in the invoice or other corresponding written agreement, until the full purchase price has been paid. The Buyer is required to keep the goods fully insured until the purchase price has been paid, just as the Buyer in this period is liable toward Cube Design for any damage that the goods may incur. Cube Design is entitled to inspect the goods at any time.

## §5 Delivery

Cube Design delivers to the distributor's warehouse, cf. applicable distributor agreement. Delivery to the end user or to a different location will only occur following an agreement.

Customs duties and local customs clearance charges are settled between the distributor and forwarding agent.

When receiving the goods, they must be inspected before signing the consignment note. Signing the consignment note means that the goods have been received and are undamaged. A damage to the goods must be noted on the consignment note and confirmed by the driver.

## §6 The Buyer's Cancellation of the Agreement

If the Buyer would like to cancel the agreement, then this can take place within 2 (two) days after the order confirmation has been issued, providing that manufacturing / shipping / delivery of the goods has not yet commenced. Such a cancellation will incur a charge of 5% of the purchase price as well as any additional losses that Cube Design may incur due to the cancellation. After this point, the agreement may not be cancelled.

## §7 Returns

Standard goods can only be returned in their original packaging and only by agreement. In case of a return, 25% of the price will be deducted or 50% if repackaging is necessary. Specially produced goods cannot be returned.

## §8 Delays

The confirmed delivery time is only a suggested deadline, since Cube Design is entitled to implement changes or to temporarily postpone delivery due to appropriate scheduling of the delivery of goods and administration.

Cube Design cannot be held liable for any losses incurred by the Buyer due to a changed or postponed delivery time. The Buyer cannot terminate the agreement due to a delivery delay caused by Cube Design, unless the delay exceeds 3 (three) months. The Buyer cannot claim compensation due to a delay on behalf of Cube Design.

## §9 Delay on the Part of the Buyer

If the Buyer realises that he is unable to receive the goods on the agreed day or that a delay on his part is likely, then he must immediately notify Cube Design in writing and indicate the reason for the delay and, to the extent possible, indicate the time when it is estimated that the goods can be received. Regardless of whether the Buyer fails to receive the goods at the agreed time, he is obliged to pay any payments pertaining to the delivery as if delivery of the respective goods had taken place. Cube Design shall ensure that the goods are stored at the Buyer's risk and expense. Upon request of the Buyer, Cube Design shall insure the goods at the Buyer's expense. Cube Design is entitled to demand in writing that the Buyer receives the goods within a deadline of 15 days. If the Buyer fails to do this within the deadline due to reasons for which Cube Design is not responsible, then Cube Design is entitled to notify the Buyer in writing that the agreement is terminated for the portion of the goods that were ready for delivery and that were not received due to the Buyer's delay. Cube Design is then has the right to compensation for the damages caused by the Buyer's breach of contract.

## §10 Deficiencies Etc.

Cube Design is only responsible for deficiencies in the sold goods if these are caused by the materials used or the workmanship. In particular, Cube Design is thus not responsible for conditions caused by incorrect or abnormal use or storage, including in relation to climate and temperature conditions and also in relation to Cube Design's instructions.

When the risk for the goods has been transferred to the Buyer, Cube Design can only be held liable for faults and deficiencies to the extent that is indicated in this provision.

The Buyer is obliged to carry out a detailed inspection of the goods immediately after reception. Complaints regarding deficiencies and/or visible transport damage that is, or should have been, detected during this inspection shall be specified on the consignment note, which must be immediately returned so that Cube Design is promptly informed of this. Any complaints regarding "non-visible" transport damage must be received by Cube Design no later than five (5) days after the delivery date, and similarly, complaints regarding any other realised deficiencies must in all cases be forwarded no later than five (5) days after they have been, or should have been, discovered. If the complaint is not submitted on time in accordance with this provision, then right to make a claim in relation to any deficiencies shall be void.

A complaint must be in writing and contain a specific description of the deficiency with associated photo documentation, or alternatively, it must include the deficient component/goods. Cube Design is required to rectify all deficiencies caused by faults in construction, materials or manufacturing by performing repairs or replacing the goods in accordance with the points below, however Cube Design is not liable for compensation due to the following: minor problems, colour differences, strong or weak growth rings in the wood and growth lines in the leather, since these are a sign of genuineness and cannot be regarded as deficiencies.

---

# TERMS & CONDITIONS

---

In case of deficiencies for which Cube Design is liable, the Buyer is not entitled to make any other claim beyond replacement of the product, which will take place at no expense to the Buyer. The Buyer is thus, in particular, not entitled to cancel the deal or to demand a proportional discount, compensation or repayment, unless the realised deficiency is due to gross negligence or intent on the part of Cube Design. However, Cube Design can under no circumstances be held liable for operational losses, lost profits, time-sensitive losses or other indirect losses that the Buyer may have incurred.

The deficient goods belong to Cube Design and must be returned to Cube Design upon request. As a general rule, the Buyer bears the costs and risk associated with this transport. Unless Cube Design has expressly agreed to be responsible for the sold goods for a longer period of time, Cube Design can under no circumstances be held liable for faults and deficiencies that have not been reported in writing within 2 (two) years after delivery to the Buyer.

## §11 Product Liability

The Buyer shall compensate and indemnify Cube Design for any compensation claims from a third party due to damages for which Cube Design is not liable towards the Buyer.

Cube Design is liable in damages resulting from defective products, pursuant to the provisions in Act no. 371 of 7 June 1989 (the Danish Products Liability Act). The liability to pay damages may not exceed DKK 50,000, and Cube Design can under no circumstances be held liable for operational losses, lost profits, time-sensitive losses or other indirect losses.

The Buyer must immediately inform Cube Design of any cases where a third party has initiated legal proceedings or otherwise made a claim due to damages caused by products produced by Cube Design.

## §12 Design Changes

Cube Design reserves the right to, without prior notice, carry out whatever changes to the design, etc. of the products is deemed necessary. Similarly, Cube Design reserves the right to change colours in connection with fabrics, linoleum and laminate. In such cases, notification of significant changes will be sent to the Buyer prior to delivery.

## §13 Invocation of Rights

If Cube Design fails to exercise or assert one of the rights that it has in relation to these terms, then this shall not be regarded as a renunciation of said right on the part of Cube Design. Nor shall it prevent such a right to be exercised or asserted at a later point.

## §14 Disputes and Choice of Law

Any dispute that may arise in connection with fulfillment of the agreement entered into in relation to the present sale and delivery terms as well as any condition associated therewith must be settled by Sø- og Handelsretten (the Maritime and Commercial High Court) in Copenhagen. Any dispute must be settled in accordance with Danish law, more specifically Act no 237 of 28 March 2003 (the Sale of Goods Act), to the extent that this has not been deviated from above.

## Furthermore

Cube Design A/S reserves the right to correct any printing errors.

Reservations are made for price changes due to fluctuations in currency exchange rates.

The price list applicable at any given time can be found on Cube Design's website : [www.cube-design.dk/en/downloads/pricelist/](http://www.cube-design.dk/en/downloads/pricelist/)

**The prices stated in the price list are recommended sales prices and are presented in EURO excluding VAT.**

## Architectural assistance

For architectural assistance and drawing by our in-house architects is a fee of EURO 95,- per started hour.

## General information concerning damaged goods

When you receive a product from Cube Design, there are a few things you should be aware of. If you have any questions or the slightest doubt please contact Cube Design.

When receiving your goods it is important to check the packing for any damages or scratches.

- If there are damages on the packing, please write this on the consignment note before signing it. Remember to contact Cube Design.
- If the package is pressed or has small scratches, you must acknowledge this on the consignment note as well. Then check the goods and contact Cube Design if the goods are damaged.
- If you notice clear damages on the goods after signing the consignment note and the driver is driven, we recommend that you contact Cube Design as soon as possible - without moving the item. Please take pictures of the packaging and do not unpack the item.

When receiving your products, unpack them and check if they look fine and have no visible damage. If something - unexpectedly - is not the way it should be, it is very important that you contact Cube Design as soon as possible.

Make sure that all products are correct and check if all accessories are included. If something is missing, we apologize in advance!  
Please contact Cube Design so we can send the missing parts right away.

**INDEX** Item no.

0500 124	113, 122, 125, 128, 130	3538 132	3900.4200 121	4956 85	5090 11	5265 16, 55
0506.0000 98, 124	3261 107, 113, 122	3540 132	3900.4800 121	4958 85	5091 11	5275 33
0506.0010 124	3262 85	3544 132	3900.5400 121	4960 85	5093 11	5276 34
0506.0015 124	3264 78, 85, 92	3549 132	3900.6000 121	4970 86	5094 11	5277 34
0506.0020 124	3273 77, 85, 92, 122	3552 132	4101 8	4975 86	5095 11	5278 34
0507.0010 124	3274 77, 85, 92, 122	3554 132	4102 8, 12	4976 82	5096 11	5279 34
0508B 125	3275 113	3556 132	4103 8	4978 82	5098 12	5280 33
0509B 125	3277 77, 85, 92, 107,	3558 132	4104 8	4980 82	5099 12	5282 33
0510B 125	113, 122, 125, 128, 130,	3560 132	4115 8, 9, 56	4982 82	5102 38	5290 32
0511B 125	132, 135	3562 132	4116 9, 56	4984 82	5103 38	5291 32
0512B 125	3280 52	3564 132	4125 9	4988 82	5104 38	5292 32
0513B 125	3287 77, 85, 92, 107,	3570 135	4126 9	4990 82	5105 38	5293 32
0514B 125	113, 122, 125, 128, 130,	3581 25	4127 9	4992 82	5106 38	5294 32, 55
0515B 125	132, 135	3582 25	4130 12	4994 82	5107 24	5295 32, 55
0516B 125	3297 77, 85, 92, 107,	3583 25	4150 51	4996 82	5112 26, 34, 38, 47, 50,	5296 32, 55
0517B 125	113, 122, 125, 128, 130,	3584 25	4151 51	4997 82	68, 71	5297 15
0518B 125	132, 135	3592 122	4152 52	4998 82	5113 26, 34, 38, 47, 50,	5297ECO 15
0536B 125	3312 128	3593 120, 122	4160 52	4999 82	68, 71	5298 15
0537B 125	3314 128	3594 122	4161 52	5002 37	5114 26, 34, 38, 47, 50,	5298ECO 15
0538B 125	3316 128	3595 122	4162 52	5003 37	68, 71	5299 15
0539B 125	3318 128	3596 85	4170 52	5004 37	5115 26, 34, 38, 47, 50,	5299ECO 15
0540B 125	3320 128	3600.3600 120	4171 52	5005 48	68, 71	5301 14
0541B 125	3322 128	3600.4200 120	4172 52	5006 48	5118 34	5301ECO 14
0542B 125	3324 128	3600.4800 120	4612 82	5007 48	5119 27, 47, 68	5302 14, 51
0570 98, 122, 125	3326 128	3600.5400 120	4614 82	5011 44, 55	5120 27, 37, 47, 50,	5302ECO 14
0601 104, 124	3328 128	3600.6000 120	4616 82	5011ECO 44	68, 71	5303 14
0602 124	3330 128	3612 118	4618 82	5012 44	5121 41	5303ECO 14
0604 124	3388 119	3614 118	4620 82	5012ECO 44	5122 41	5304 14
0606 124	3400 132, 135	3616 118	4632 82	5013 44, 55	5123 41	5304ECO 14
0607 124	3400.3610 114	3618 118	4634 82	5013ECO 44	5125 41	5305 14
0608 124	3400.3612 114	3620 118	4636 82	5014 44	5128 27, 47	5305ECO 14
3100H 134	3400.3614 114	3622 118	4638 82	5014ECO 44	5129 27, 68	5306 14
3110 134	3400.3616 114	3624 118	4640 82	5015 44, 55	5132 27, 47, 50, 68	5306ECO 14
3111 134	3400.4210 114	3626 118	4712 83, 124	5015ECO 44	5133 47	5307 14
3112 134	3400.4212 114	3628 118	4712ECO 82	5016 44	5134 27, 68, 71	5307ECO 14
3130 134	3400.4214 114	3630 118	4714 83, 124	5016ECO 44	5136 27, 47, 50, 68	5308 15
3131 134	3400.4216 114	3671 118	4714ECO 82	5019 44, 55	5137 41	5308ECO 15
3132 134	3400.4810 114	3672 118	4716 83, 124	5019ECO 44	5138 27, 47	5309 15
3151 23	3400.4812 114	3673 118	4716ECO 82	5020 44	5139 27, 50	5309ECO 15
3151ECO 23	3400.4814 114	3674 118	4718 83, 124	5020ECO 44	5140 26, 34, 38, 47, 50,	5310 16
3152 23	3400.4816 114	3675 118	4718ECO 82	5021 45, 55	68, 71	5310ECO 16
3152ECO 23	3400.4818 114	3676 118	4720 83, 124	5021ECO 45	5142 26, 34, 38, 47, 50,	5311 16
3153 23	3400.4820 114	3677 118	4722 83, 124	5022 45	68, 71	5311ECO 16
3153ECO 23	3400.5410 115	3678 119	4724 83, 124	5022ECO 45	5143 26, 34, 38, 47, 50,	5312 16
3154 23	3400.5412 115	3680 119	4726 83, 124	5023 45	68, 71	5312ECO 16
3154ECO 23	3400.5414 115	3682 119	4728 83, 124	5023ECO 45	5144 26, 34, 38, 47, 50,	5313 16, 51, 52
3155 23	3400.5416 115	3686 119	4730 83, 124	5024 45	68, 71	5313ECO 16
3155ECO 23	3400.5418 115	3690 118	4732 83, 124	5024ECO 45	5145 34	5314 16
3156 23, 33, 52	3400.5420 115	3692 118	4734 83, 124	5025 45	5146 27, 47, 50, 68	5314ECO 16
3156ECO 23	3400.6010 115	3694 118	4736 83, 124	5025ECO 45	5147 27, 47, 50, 68	5315 17
3157 23	3400.6012 115	3696 118	4738 83, 124	5026 45	5148 26, 34, 38, 47, 50,	5315ECO 17
3157ECO 23	3400.6014 115	3712 118	4740 83, 124	5026ECO 45	68, 71	5316 16
3158 23, 33	3400.6016 115	3714 118	4802 83	5027 45	5149 26, 34, 38, 47, 50,	5316ECO 16
3158ECO 23	3400.6018 115	3716 118	4804 83	5027ECO 45	68, 71	5317 17
3161 23	3400.6020 115	3718 118	4806 83	5028 45	5155 40	5317ECO 17
3161ECO 23	3401 135	3720 118	4808 83	5028ECO 45	5156 40	5318 17
3162 23	3402 132, 135	3722 118	4810 83	5029 45	5157 40	5318ECO 17
3162ECO 23	3403 132	3724 118	4812 83	5029ECO 45	5158 40	5319 17
3163 23	3405 92	3726 118	4812ECO 82	5030 45	5167 40	5319ECO 17
3163ECO 23	3406 92, 122	3728 118	4814 83	5030ECO 45	5168 40	5320 16, 55
3164 23	3407 78, 85, 92	3730 118	4814ECO 82	5031 45, 55	5180 38, 71	5320ECO 16
3164ECO 23	3409 122	3734 118	4816 83	5031ECO 45	5183 36	5321 17, 55
3165 23	3410 78, 85, 92, 113,	3736 118	4816ECO 82	5032 45	5183ECO 36	5321ECO 17
3165ECO 23	122, 125	3738 118	4818 83	5032ECO 45	5184 36	5322 14
3166 23	3413 128, 130	3740 118	4820 83	5033 46, 55	5184ECO 36	5322ECO 14
3166ECO 23	3414 80, 88, 94, 113,	3741 118	4822 83	5033ECO 46	5186 29, 34, 38	5323 18
3167 23	122, 135	3742 118	4824 83	5034 46	5187 29, 34, 38	5323ECO 18
3167ECO 23	3415 80, 88, 94, 113,	3743 118	4826 83	5034ECO 46	5198 36	5324 14
3168 23	122, 135	3744 118	4828 83	5035 46	5198ECO 36	5324ECO 14
3168ECO 23	3417 108, 109, 115,	3746 118	4830 83	5035ECO 46	5199 36	5325 18
3171 23	122	3748 118	4853 84	5036 46	5199ECO 36	5325ECO 18
3171ECO 23	3419 125	3750 118	4854 84	5036ECO 46	5201 36	5326 17, 55
3172 23	3424 108, 109, 115,	3751 119	4855 84	5037 44	5201ECO 36	5326ECO 17
3172ECO 23	122	3752 119	4856 84	5037ECO 44	5202 36	5327 17
3173 23	3425 79, 88, 94, 108,	3753 119	4871 84	5038 44	5202ECO 36	5327ECO 17
3173ECO 23	109, 115, 122	3754 119	4872 84	5038ECO 44	5203 36	5328 14
3174 23	3426 79, 88, 94, 108,	3756 119	4873 84	5039 44	5203ECO 36	5328ECO 14
3174ECO 23	109, 115, 122	3758 119	4874 84	5039ECO 44	5204 36	5329 14
3175 23	3427 108, 109, 115,	3760 119	4881 85	5040 44	5204ECO 36	5329ECO 14
3175ECO 23	122	3761 119	4882 85	5040ECO 44	5207 36	5330 19
3176 23	3429 107, 113	3762 119	4883 85	5041 46	5207ECO 36	5330ECO 19
3176ECO 23	3434 113	3763 119	4884 85	5041ECO 46	5208 36	5331 19
3177 23	3435 113	3764 119	4893 84	5042 46	5208ECO 36	5331ECO 19
3177ECO 23	3436 113	3766 119	4894 84	5042ECO 46	5209 36	5332 16, 55
3178 23	3437 113	3768 119	4895 84	5045 46	5209ECO 36	5332ECO 16
3178ECO 23	3438 113	3770 119	4896 84	5045ECO 46	5210 37	5333 16, 55
3181 46	3439 113	3771 119	4906 85	5046 46	5214 37	5333ECO 16
3181ECO 46	3440 74	3772 119	4907 85	5046ECO 46	5218 20	5334 19
3182 46	3441 74	3773 119	4912 83	5050 58	5219 20	5335 19
3182ECO 46	3442 74	3774 119	4914 83	5052 58	5220 20	5336 19
3183 46	3445 80, 88, 94, 113,	3776 119	4916 83	5054 58	5221 20, 56	5336ECO 19
3183ECO 46	122, 135	3778 119	4918 83	5056 58	5228 20	5337 19
3184 46	3460 113	3780 119	4920 83	5060 58	5229 20	5337ECO 19
3184ECO 46	3461 113	3784 119	4922 84	5062 58	5230 24	5338 19
3185 44	3462 113	3786 119	4924 84	5064 58	5232 24, 51, 52	5339 19
3185ECO 44	3463 113	3788 119	4926 84	5066 58	5240 25	5340 19
3186 44	3464 113	3790 119	4928 84	5071 58	5242 25	5341 19
3186ECO 44	3465 113	3812 130	4930 84	5072 56, 58	5244 25	5342 14
3191 46	3467 135	3814 130	4932 84	5073 58	5246 25	5342ECO 14
3191ECO 46	3470 113	3816 130	4934 84	5078 12	5248 25	5343 14
3192 46	3471 113	3818 130	4936 84	5079 12	5250 25	5343ECO 14
3192ECO 46	3472 113	3820 130	4938 84	5081 10	5252 25	5344 14
3245 101	3474 113	3822 130	4940 84	5082 10, 56	5254 25	5345 14
3246 101	3475 113	3824 130	4944 86	5083 10	5256 25	5345ECO 14
3247 101	3525 132	3826 130	4946 86	5086 10	5258 25	5346 14
3250 40	3532 132	3828 130	4948 86	5087 10, 56	5260 25	5346ECO 14
3255 119	3534 132	3830 130	4952 85	5088 10	5262 25	5347 14
3260 78, 85, 92, 107,	3536 132	3900.3600 121	4954 85	5089 52	5264 16	5347ECO 14



# INDEX Item no.

5348 15	5427 16, 55	5575 20, 48, 52	5896 92	6404 62	6922 77	9865 97
5349 19	5428 20	5576 28	5905 91	6411 64	6924 77	9867 97
5350 19	5429 20	5577 28	5906 91	6412 64	6926 77	9871 97
5351 16, 51, 52, 55	5431 19	5578 37	5907 91	6413 64	6928 77	9881 98
5351ECO 16	5431ECO 19	5579 37	5912 90	6414 64	6930 77	9891 98
5352 16, 55	5432 19	5580 26	5914 90	6415 64	6932 77	9892 98
5352ECO 16	5433 19	5580L 26	5916 90	6416 64	6934 77	9893 98
5353 16	5433ECO 19	5581 26, 51, 52	5918 90	6417 64	6936 77	341010 113
5354 16, 55	5435 9, 10, 19, 33, 46, 51, 58	5581L 26	5920 90	6418 64	6938 77	341608 112
5354ECO 16	5435ECO 19, 46	5582 26	5922 91	6434 64	6940 77	341609 112
5355 17, 55	5435P 10	5582L 26	5924 91	6435 64	7001 30	341610 112
5355ECO 17	5435P 10	5584 26	5926 91	6436 64	7002 30	341612 112
5356 16	5437 19, 33, 46, 58	5584L 26	5928 91	6437 64	7003 30	341616 113
5357 17, 55	5437ECO 19, 46	5585 26	5930 91	6438 64	7004 30	341808 112
5357ECO 17	5450 27, 37, 41, 48, 66, 70	5585L 26	5932 91	6439 64	7005 30	341809 112
5358 17, 55	5451 27, 41, 48, 66	5586 26	5934 91	6481 65	7006 30	341810 112
5358ECO 17	5452 21	5586L 26	5936 91	6483 65	7007 30	341812 112
5359 17	5453 21	5587 26	5938 91	6489 66	7011 30	341818 113
5360 16	5453 21	5587L 26	5940 91	6490 66	7012 30	342008 112
5361 17	5454 21	5588 50	5945 78, 86, 92	6491 66	7013 30	342009 112
5362 18	5456 27, 41, 48, 66	5590 50	5946 78, 86, 92	6492 66	7014 30	342010 112
5363 18	5457 21	5594 50	5947 78, 86, 92	6493 66	7015 30	342012 112
5363ECO 18	5458 21	5596 37, 71	5948 78, 86, 92	6495 66	7016 30	342020 113
5364 15	5459 21	5597 34	5949 78, 86, 92	6496 66	7017 30	342408 112
5364ECO 15	5463 27, 41, 66	5598 34	5950 74, 78, 87, 93	6497 66	7021 30	342409 112
5365 18	5464 27, 41	5611 55	5951 78, 87, 93	6498 66	7023 30	342410 112
5365ECO 18	5465 27, 48, 66	5615 55	5951A 78, 87, 93	6499 66	7024 30	342412 112
5366 15	5466 27, 51, 52, 66	5618 55	5952 78, 87, 93	6502 67	7025 30	342808 112
5366ECO 15	5469 20, 66	5621 34	5952A 78, 87, 93	6503 67	7440 79, 88, 93	342809 112
5367 19	5470 51, 52	5631 28	5953 78, 87, 93	6504 67	7442 79, 88, 93	342810 112
5368 19	5471 27, 41	5632 28	5953A 78, 87, 93	6512 67	7443 79, 88, 93	342812 112
5369 19	5472 27, 41	5633 28	5954 78, 87, 93	6513 67	7444 79, 88, 93	342814 112
5370 19	5473 27, 41	5634 28	5955 78, 87, 93	6514 67	7445 79, 88, 94	342816 112
5370ECO 19	5480 22, 59	5635 28	5956 78, 87, 93	6515 67	7446 79, 88, 93	343008 112
5371 19, 51	5481 22, 33, 47, 59	5641 28	5957 50	6516 67	7447 79, 88, 94	343009 112
5371ECO 19	5482 22, 33, 47, 59	5642 28	5958 50	6517 67	7452 52	343010 112
5372 19	5483 22, 33	5643 28	5959 50	6518 67, 71	7465 78, 86, 93	343012 112
5372ECO 19	5487 21	5644 28	5960 50	6519 67, 71	7466 78, 86, 93	343014 112
5373 32	5488 21	5645 28	5961 87	6520 70	7467 78, 86, 93	343016 112
5374 19	5489 21	5658 29	5961A 87	6523 68	7468 78, 86, 93	351010 106
5375 33	5490 21	5659 29	5962 87	6524 68	7469 78, 86, 93	351011 107
5376 33	5491 21	5660 29	5962A 87	6525 68	7470 78, 86, 93	351010 106
5377 19	5492 21	5661 29	5963 87	6526 68	7478 79, 88, 93	351611 107
5377ECO 19	5493 21	5662 29	5963A 87	6527 68	7479 79, 88, 93	351612 106
5378 15	5495 21	5668 29	5970 74	6528 68	7480 79, 88, 93	351616 106
5378ECO 15	5496 21	5669 29	5971 74	6540 68	7481 79, 88, 93	351617 107
5379 18	5497 21	5670 29	5972 74	6541 68	7482 79, 88, 94	351680 106
5379ECO 18	5498 21	5671 29	5973 74	6545 68	7483 78, 85, 92	351681 107
5380 8	5499 21	5672 29	5974 74	6546 68	7487 87, 94	351810 106
5381 8, 9, 56	5502 24	5678 29	5981 74	6548 68	7488 79, 88, 93	351811 107
5382 9	5503 24	5679 29	5982 74	6549 68	7495 79, 87, 93	351812 106
5383 18	5504 24	5680 29	5983 74	6580 67	7496 79, 87, 93	351818 106
5383ECO 18	5507 27	5692 29	5987 74	6581 67	7497 79, 87, 93	351819 107
5384 18	5508 41	5701 87	5988 74	6585 67	7500 79, 86, 94, 108,	351880 106
5384ECO 18	5509 28	5707 87, 94	6005 80	6654 67	109, 115, 122	351881 107
5386 18	5510 28, 34	5710 90	6123 68	6655 67	7501 108, 109, 122	352010 106
5386ECO 18	5511 24	5712 90	6164 70	6656 67	7816B 98, 125	352011 107
5394 22	5512 24	5714 90	6174 70	6657 67	7817B 98, 125	352012 106
5394ECO 22	5513 24, 51, 52	5716 90	6175 70	6658 67	7818B 125	352020 106
5395 22, 33, 58	5514 24	5718 90	6176 70	6659 67	7819B 125	352021 107
5395ECO 22	5515 24	5720 90	6177 70	6660 67	7820B 125	352080 106
5396 22	5516 25	5722 90	6178 70	6661 67	7821B 125	352081 107
5396ECO 22	5517 24, 38	5724 90	6302 62	6662 67	7822B 125	352410 106
5397 22, 33, 46, 58	5518 24	5726 90	6303 62	6712 76	7950 48	352411 107
5397ECO 22, 46	5519 24	5728 90	6304 62	6714 76	7951 48	352412 106
5398 22	5520 25	5730 90	6305 62	6716 76	7952 48	352480 106
5398ECO 22	5521 22, 47, 59, 65	5732 90	6306 62	6718 76	7953 12, 48	352481 107
5399 22, 33, 46, 58	5522 22, 47	5734 90	6307 62	6720 76	7960 12	352810 106
5399ECO 22, 46	5525 12, 22, 47, 65	5736 90	6310 63	6722 76	7970 74	352811 107
5401 15	5527 12, 22, 47, 59, 65	5738 90	6311 63	6724 76	7973 80, 88, 94, 122	352812 106
5401ECO 15	5529 12, 27, 41	5740 90	6312 63	6726 76	7974 12, 52	352880 106
5402 8, 10, 15, 44, 58	5530 22, 47, 65	5780 26	6313 62	6728 76	7976 12	352881 107
5402ECO 15, 44	5531 29	5781 26	6314 62	6730 76	7980 80, 86, 94	353010 106
5402G 50	5532 29	5782 26	6317 63	6732 76	7981 80, 86, 94	353012 106
5402P 8, 10	5533 29	5784 26	6318 63	6734 76	7986 87, 94	353080 106
5403 15, 44, 58	5534 29	5785 26	6319 63	6736 76	7987 87, 94	353510 108
5403ECO 15, 44	5535 25	5786 26	6320 63	6738 76	7988 87, 94	353511 109
5404 15	5537 25	5787 26	6321 63	6740 76	7989 87, 94	353512 108
5404ECO 15	5538 29	5802 90	6322 62	6802 76	8009MIC 79, 88, 94	353580 108
5405 20	5539 29	5804 90	6324 62	6804 76	8941 78, 86	353581 109
5406 20	5540 28, 51	5806 90	6326 63	6806 76	8942 78, 86	354110 108
5407 20	5541 28	5808 90	6327 63	6808 76	8943 78, 86	354111 109
5408 20	5542 28	5810 90	6332 62	6810 76	8947 78, 86	354112 108
5409 20	5543 28	5812 90	6333 62	6812 76	8948 78, 86	354180 108
5410 20	5544 47	5814 90	6334 64	6814 76	8949 78, 86	354181 109
5411 18	5545 28	5816 90	6335 64	6816 76	9126 122	354710 108
5411ECO 18	5546 28, 47	5818 90	6336 64	6818 76	9531 27, 37, 41, 48	354711 109
5411G 50	5547 28	5820 90	6339 64	6820 76	9532 27	354712 108
5412 8, 9, 10, 18, 32, 46, 50, 51, 58	5548 28	5822 90	6340 64	6822 76	9533 27	354780 108
5412ECO 18, 46	5549 28	5824 90	6341 64	6824 76	9534 27	354781 109
5412G 50	5550 28	5826 90	6342 62	6826 76	9745 104	355410 108
5412P 10	5551 28, 50	5828 90	6343 62	6828 76	9752 104	355411 109
5413 18, 32, 46, 58	5552 28	5830 90	6346 62	6830 76	9757 104	355412 108
5413ECO 18, 46	5553 12, 20, 37, 40, 48,	5853 91	6347 62	6853 77	9761 100	355480 108
5414 18	52, 66, 71	5854 91	6351 63	6854 77	9765 101	355481 109
5414ECO 18	5557 28	5855 92	6352 63	6871 77	9768 100	356010 108
5414ECO 18	5559 20, 34	5856 92	6353 63	6872 77	9771 101	356011 109
5415 21, 64	5561 28	5871 91	6357 63	6873 77	9772 100	356012 108
5416 20	5564 28	5872 91	6358 63	6874 77	9773 100	356080 108
5417 20	5565 24	5873 91	6359 64	6893 77	9774 96, 100	356081 109
5418 22, 47, 59, 65	5566 24	5874 91	6400_0200 66, 70	6894 77	9776 96, 100	
5419 22, 33, 47, 59, 65	5567 24	5881 92	6400_0300 66, 70	6906 77	9792 101, 104	
5420 22, 33, 47, 59, 65	5568 24	5882 92	6400_0400 66, 70	6907 77	9851 96	
5421 14	5569 24	5883 92	6400_0500 66, 70	6912 76	9853 96	
5422 16	5570 24	5884 92	6401 62	6914 76	9855 96	
5423 19	5572 22, 47, 59, 65	5893 91	6401_0000 66, 70	6916 76	9857 96	
5424 14	5573 25	5894 91	6402 62	6918 76	9861 97	
5426 22, 33, 59, 65	5574 24	5895 92	6403 62	6920 76	9863 97	

**Laminate**  
Cabinet ///////////////  
Fronts ///////////////  
**HPL**  
Table tops ///////////////

Volcanic Black 12000 / 1015	Slate Grey 12231 / U164	Anthracite Grey 12290 / 1290	Platinum Grey 12115 / 1115	Montana Grey 12109 / 1109	Opaque White 10400 / 1040	Lindberg Oak 20021V / 4223V	Congo 16002
--------------------------------	----------------------------	---------------------------------	-------------------------------	------------------------------	------------------------------	--------------------------------	----------------

**Veneer**  
Cabinet ///////////////  
Fronts ///////////////  
Table tops ///////////////

Maple	Ash	Beech	Oak	Walnut	Cherry (Only table tops)
-------	-----	-------	-----	--------	-----------------------------

**NORDIC NATURE**  
**HPL**  
Table tops ///////////////  
Fronts ///////////////

Burgundy 17054	Bordeaux 17031	Powder 16037	Cashmere 12168	Congo 16002	Lava 12211	Bison 16013	Antelope 16012	Light Beige 16007
Dark Blue 18004	Water Blue 18002	Pastel Blue 18067	Lagoon 18505	Atlantic 18074	Skaggerak 18006	Zucchini 19504	Khaki 19512	Avocado 19503
Maple R27030	Beech 5311							

**XP/XM MATT HPL**  
Table tops ///////////////  
Fronts ///////////////

Volcanic Black U12000 XP	Anthracite Grey U12290 XP	Platinum Grey U12115 XP	Light Grey U12188 XP	Crystal White U11026 XP	Lindberg Oak R20021 XM
-----------------------------	------------------------------	----------------------------	-------------------------	----------------------------	---------------------------

**FENIX MATT HPL**  
Table tops ///////////////  
Fronts ///////////////

Nero Ingo 0720	Grigio Londra 0718	Bianco Male 0029
-------------------	-----------------------	---------------------

**Compact laminate**  
Top plates ///////////////

Volcanic Black 12000 / 1015	Platinum Grey 12115 / 1115	Opaque White 10400 / 1040	Carrara Marble S63009	Neuro/Portoro S63028
--------------------------------	-------------------------------	------------------------------	--------------------------	-------------------------

**LINOLEUM**  
Table tops ///////////////  
Fronts ///////////////

Nero 4023	Charcoal 4166	Iron 4178	Mauve 4172	Powder 4185	Conifer 4174	Olive 4184	Pistachio 4183	Spring Green 4182
Smokey Blue 4179	Pewter 4155	Ash 4132	Pebble 4175	Vapour 4177	Mushroom 4176	Pearl 4157	Burgundy 4154	Salsa 4164
Orange Blast 4186	Midnight Blue 4181	Aquavert 4180	Clay 4001	Leather 4002	Walnut 4003			

**ACRYLIC/GLASS**  
Doors ///////////////

Acrylic Dark grey	Acrylic Medium grey	Acrylic White	Glass Matt	Glass Clear
----------------------	------------------------	------------------	---------------	----------------

**HPL**  
Plinth for information  
desk ///////////////

Brushed alu Alu 1
----------------------



**Cura (Gabriel)**

Upholstered seat ///  
S20 chairs ///////////////  
S10 chairs ///////////////

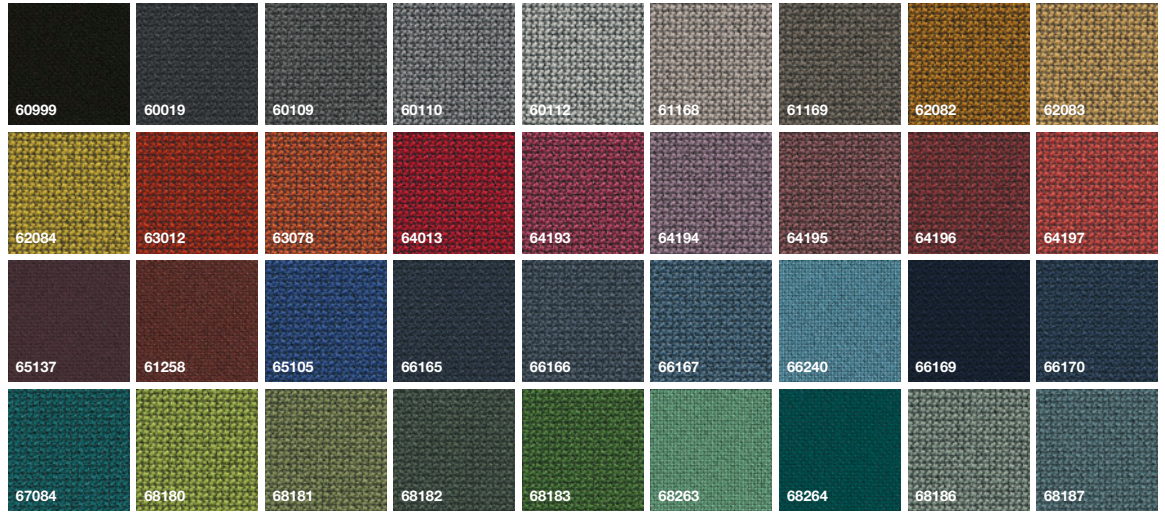

**Sydney (CAMO)**

S20 chairs ///////////////  
S10 chairs ///////////////

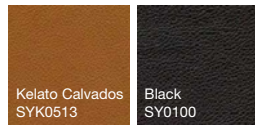

**Hush (Gabriel)**

Screen wall ///////////////



**Twist Melange (Gabriel)**

Speaker door ///////////////

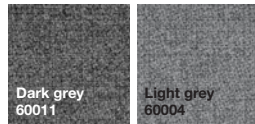

**Shell**

Vesper chairs ///////////////

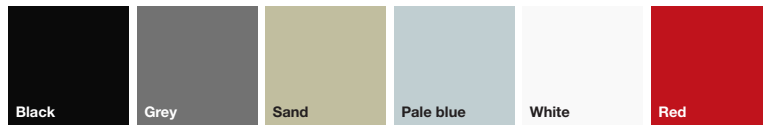

**Bondai (FI.DI.VI)**

Vesper seat



**Frames**

UP ///////////////  
RAW ///////////////  
Quadro ///////////////  
Verzo ///////////////  
Spider ///////////////  
Quadro ///////////////  
Amigo ///////////////  
Sensa ///////////////  
Flap ///////////////  
V ///////////////  
S20 ///////////////  
S10 ///////////////  
Vesper 1 ///////////////  
Vesper 12 ///////////////

	White powder coat	Alu powder coat	Black powder coat	Polished chrome	Polished	Brushed stainless steel	Oak
UP	X	X	X				
RAW	X	X	X				
Quadro	X	X	X	X			
Verzo			X				X
Spider	X		X				X
Quadro	X	X	X	X			
Amigo	X	X	X			X	
Sensa		X	X				
Flap	X	X	X				
V	X	X	X				
S20			X	X	X		
S10				X			
Vesper 1	X		X	X			
Vesper 12				X			

